

ClassPad 330

ClassPad OS Version 3.04

User's Guide

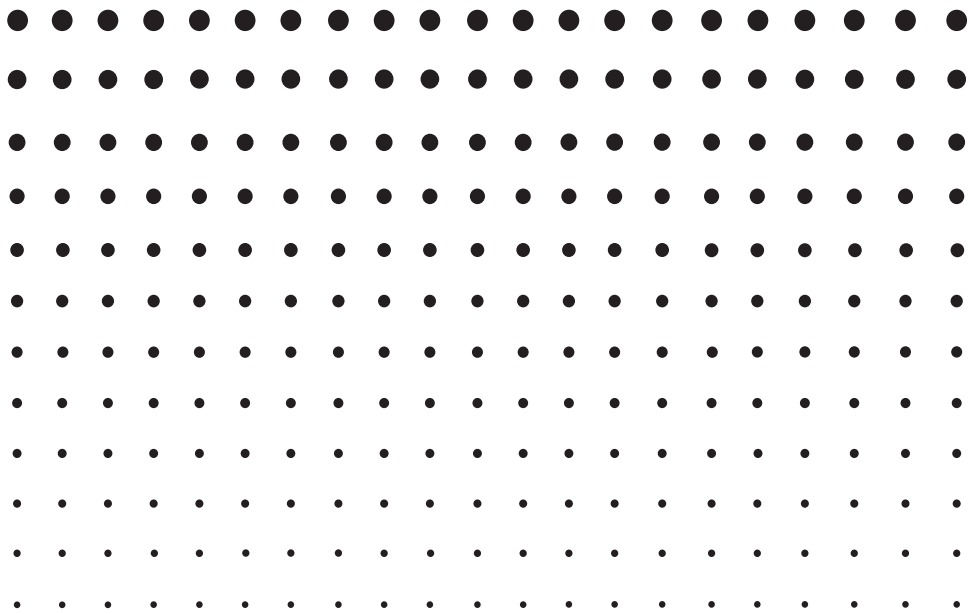

CASIO Education website URL

<http://edu.casio.com>

ClassPad website URL

<http://edu.casio.com/products/classpad/>

ClassPad register URL

<http://edu.casio.com/dl/>

GUIDELINES LAID DOWN BY FCC RULES FOR USE OF THE UNIT IN THE U.S.A. (not applicable to other areas).

NOTICE

This equipment has been tested and found to comply with the limits for a Class B digital device, pursuant to Part 15 of the FCC Rules. These limits are designed to provide reasonable protection against harmful interference in a residential installation. This equipment generates, uses and can radiate radio frequency energy and, if not installed and used in accordance with the instructions, may cause harmful interference to radio communications. However, there is no guarantee that interference will not occur in a particular installation. If this equipment does cause harmful interference to radio or television reception, which can be determined by turning the equipment off and on, the user is encouraged to try to correct the interference by one or more of the following measures:

- Reorient or relocate the receiving antenna.
- Increase the separation between the equipment and receiver.
- Connect the equipment into an outlet on a circuit different from that to which the receiver is connected.
- Consult the dealer or an experienced radio/TV technician for help.

FCC WARNING

Changes or modifications not expressly approved by the party responsible for compliance could void the user's authority to operate the equipment.

Proper connectors must be used for connection to host computer and/or peripherals in order to meet FCC emission limits.

Connector SB-62

USB connector for the ClassPad

ClassPad to ClassPad

ClassPad to Windows® compatible PC

Declaration of Conformity

Model Number: ClassPad 330

Trade Name: CASIO COMPUTER CO., LTD.

Responsible party: CASIO AMERICA, INC.

Address: 570 MT. PLEASANT AVENUE, DOVER, NEW JERSEY 07801

Telephone number: 973-361-5400

This device complies with Part 15 of the FCC Rules. Operation is subject to the following two conditions: (1) This device may not cause harmful interference, and (2) this device must accept any interference received, including interference that may cause undesired operation.





Getting Ready

This section contains important information you need to know before using the ClassPad for the first time.

1. Unpacking

When unpacking your ClassPad, check to make sure that all of the items shown here are included. If anything is missing, contact your original retailer immediately.

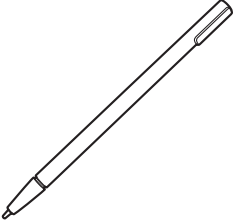
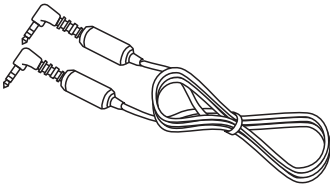
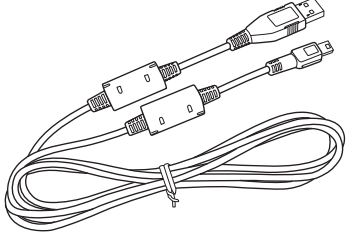
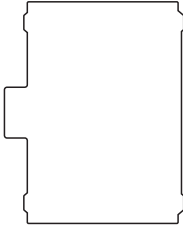
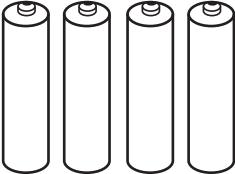
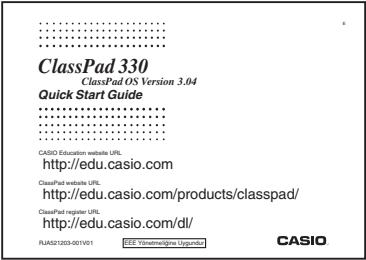
<p>ClassPad</p> 	<p>CD-ROM</p> 	<p>Front Cover (Attached to ClassPad.)</p> 
<p>Stylus (Inserted in ClassPad.)</p> 	<p>3-pin Cable (SB-62)</p> 	<p>USB Cable</p> 
<p>Touch Screen Protector</p>  <p>(The protector is already installed on the touch screen when you purchase the ClassPad.)</p>	<p>Four AAA-size Batteries LR03 (AM4)</p> 	<p>Quick Start Guide</p> 



2. Attaching and Removing the Front Cover

- **To remove the front cover**

Before using the ClassPad, remove the front cover and attach it to the back.

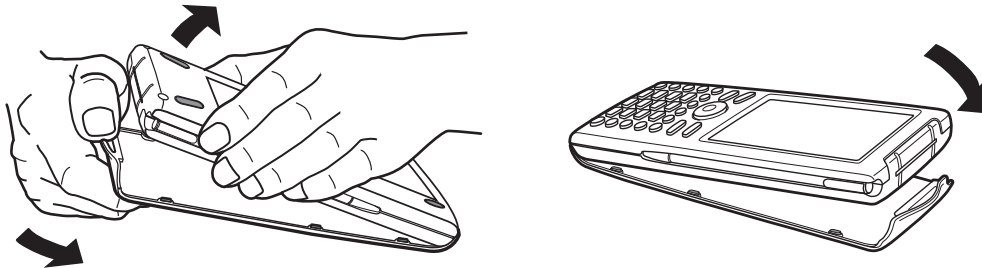

- **To attach the front cover**

When you are not using the ClassPad, attach the front cover to the front.

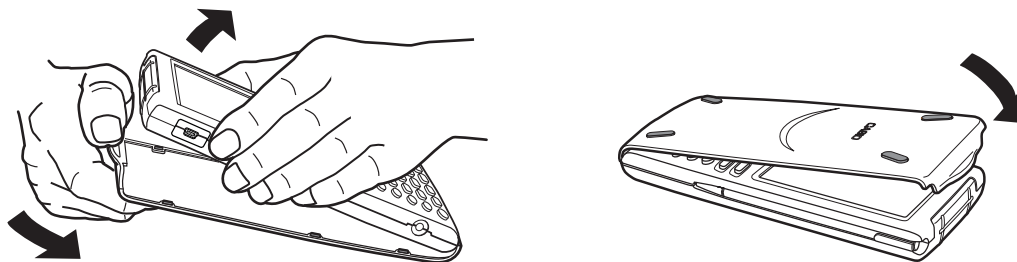

Important!

- Always attach the front cover to the ClassPad whenever you are not using it. Otherwise, accidental operation of the touch screen or the **ON/OFF** key can cause the power to turn on and run down the batteries.



3. Using the Stylus

Slide the stylus from the slot provided for it on the ClassPad, and then use it to perform touch panel operations.

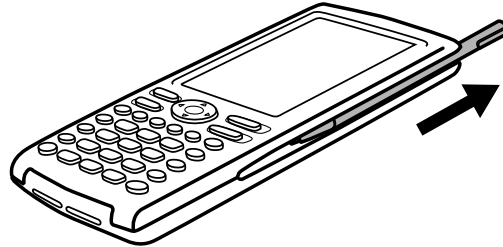

Important!

- Be careful so that you do not misplace or lose the stylus. When you are not using it, always keep the stylus in the slot provided for it on the ClassPad.
- Be careful so that you do not damage the tip of the stylus. A damaged tip can scratch or otherwise damage the ClassPad touch panel.
- Use only the supplied stylus or a similar instrument to perform touch panel operations. Never use a pen, pencil, or other writing instrument.

4. Replacing Batteries and Setting Up the ClassPad

• ClassPad Operation

- (1) Making sure that you do not accidentally press the **ON/OFF** key, attach the front cover to the ClassPad and then turn the ClassPad over. Remove the battery cover from the ClassPad by pulling with your finger at the point marked ①.

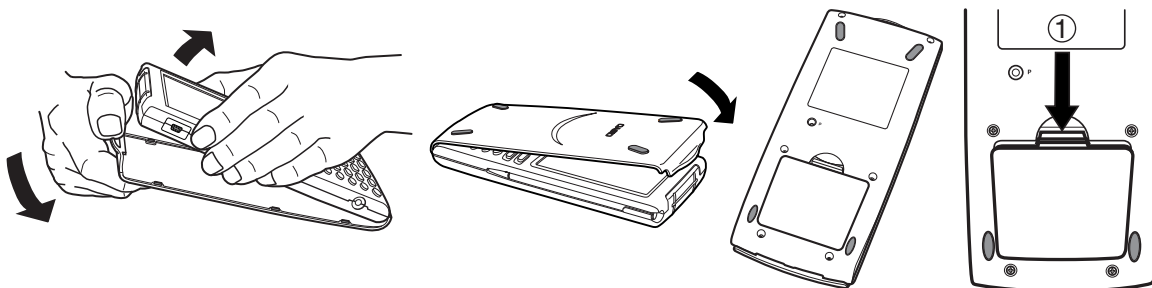

- (2) Load the four batteries that come with ClassPad.

- Make sure that the positive (+) and negative (–) ends of the batteries are facing correctly.

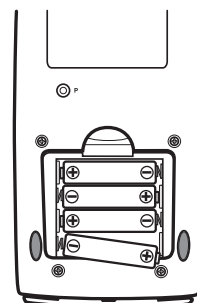



(3) Replace the battery cover, making sure that its tabs enter the holes marked ② and turn the ClassPad front side up.

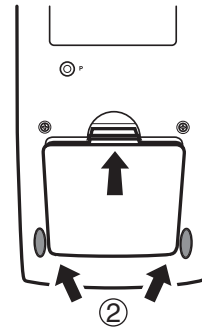

(4) Remove the front cover from the ClassPad.

(5) Align the touch panel.

a. Your ClassPad should turn on automatically and display the Touch Panel Alignment screen.

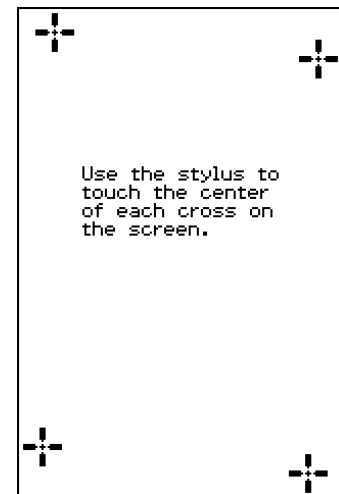

b. Tap the center of each of the four cross marks as they appear on the display.

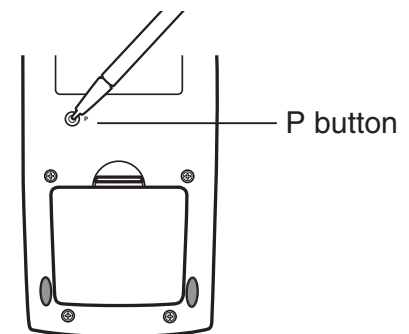

- If the Touch Panel Alignment screen does not appear, use the stylus to press the P button on the back of the ClassPad.



Important!

- It may take a little time for your ClassPad to start up after you press the P button.

(6) Adjust the display contrast.

a. Tap the  button to make contrast darker, or the  button to make it lighter.



b. After the contrast setting is the way you want, tap [Set].

- Tapping [Initial] on the Contrast dialog box returns contrast to its initial factory default setting.



(7) Specify the display language.

- a. On the list that appears, tap the language you want to use.
- You can select German, English, Spanish, French, or Portuguese.



b. When the language you want is selected, tap [Set].

- Tapping [Cancel] selects English and advances to the next dialog box.

(8) Specify the soft keyboard key arrangement.

- a. On the list that appears, tap the key arrangement you want to use.



b. When the key arrangement you want is selected, tap [Set].

- Tapping [Cancel] selects QWERTY arrangement and advances to the next dialog box.

(9) Specify the font set.

- a. On the list that appears, tap the font set you want to use.
- You can select Regular or Bolder.

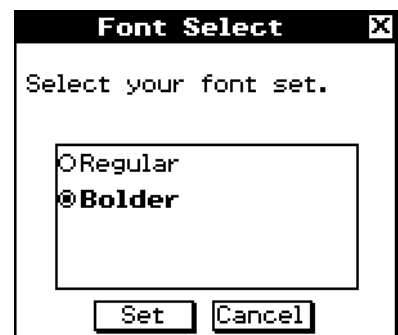

b. When the font set you want is selected, tap [Set].

- Tapping [Cancel] selects Bolder and advances to the next dialog box.



(10) Configure power properties.

- a. Configure the Power Save Mode and Auto Power Off settings.
 - See “Power Saving Mode” and “Auto Power Off” on page 16-6-1 for details about these settings.
- b. When the configurations are the way you want, tap [Set].
 - Tapping [Cancel] selects “1 day” for [Power Save Mode] and “6 min” for [Auto Power Off], and finalizes the setup operation.

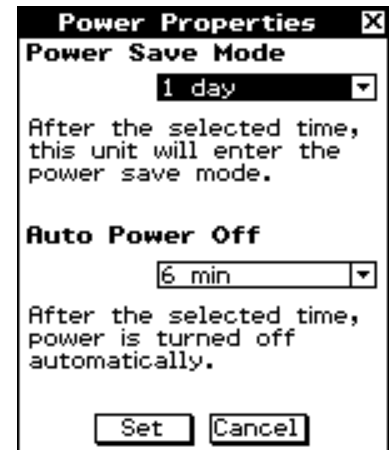

5. User Registration

Before using your ClassPad or OH-ClassPad, be sure to read the contents of the file named **Readme.html**, which is on the bundled CD-ROM. There you will find the URL for a Website where you can register as an official user.

<http://edu.casio.com/dl/>



Handling Precautions

- Your ClassPad is made of precision components. Never try to take it apart.
- Avoid dropping your ClassPad and subjecting it to strong impact.
- Do not store the ClassPad or leave it in areas exposed to high temperatures or humidity, or large amounts of dust. When exposed to low temperatures, the ClassPad may require more time to display results and may even fail to operate. Correct operation will resume once the ClassPad is brought back to normal temperature.
- Replace the batteries once every one year regardless of how much the ClassPad is used during that period. Never leave dead batteries in the battery compartment. They can leak and damage the ClassPad.
- Do not use an oxyride battery or any other type of nickel-based primary battery with this product. Incompatibility between such batteries and product specifications can result in shorter battery life and product malfunction.
- Keep batteries out of the reach of small children. If swallowed, consult a physician immediately.
- Avoid using volatile liquids such as thinners or benzine to clean the ClassPad. Wipe it with a soft, dry cloth, or with a cloth that has been moistened with a solution of water and a neutral detergent and wrung out.
- Always be gentle when wiping dust off the display to avoid scratching it.
- In no event will the manufacturer and its suppliers be liable to you or any other person for any damages, expenses, lost profits, lost savings or any other damages caused by loss of data and/or formulas arising out of malfunction, repairs, or battery replacement. It is up to you to prepare physical records of data to protect against such data loss.
- Never dispose of batteries, the liquid crystal panel, or other components by burning them.
- When the “Batteries are extremely low!” message appears on the display, replace the batteries as soon as possible.
- Be sure to turn off the ClassPad before replacing the batteries.
- If the ClassPad is exposed to a strong electrostatic charge, its memory contents may be damaged or the keys may stop working. In such a case, perform the reset operation to clear the memory and restore normal key operation.
- If the ClassPad stops operating correctly for some reason, use the stylus to press the P button on the back of the ClassPad. Note, however, that this clears all the data in ClassPad memory.
- Note that strong vibration or impact during program execution can cause execution to stop or can damage the ClassPad’s memory contents.
- Using the ClassPad near a television or radio can cause interference with TV or radio reception.
- Before assuming malfunction of the ClassPad, be sure to carefully reread this user’s guide to ensure that the problem is not due to insufficient battery power, programming, or operational errors.
- Make sure nothing gets between the front cover and the touch screen. Besides creating the risk of scratching the touch screen, an object coming into contact with the screen can cause the power to turn on and run down the batteries.
- Always attach the front cover to the ClassPad whenever you are not using it. Otherwise, accidental operation of the touch screen or the  key can cause the power to turn on and run down the batteries.



Be sure to keep physical records of all important data!

Low battery power or incorrect replacement of the batteries that power the ClassPad can cause the data stored in memory to be corrupted or even lost entirely. Stored data can also be affected by strong electrostatic charge or strong impact. It is up to you to keep back up copies of data to protect against its loss.

Backing Up Data

Your ClassPad comes bundled with a special USB cable and FA-CP1 software, which you can use to backup data to a computer running Windows® 98 SE, Windows® Me, Windows® XP, Windows® 2000, or Windows Vista®.

- The FA-CP1 software is on the CD-ROM.

In no event shall CASIO Computer Co., Ltd. be liable to anyone for special, collateral, incidental, or consequential damages in connection with or arising out of the purchase or use of these materials. Moreover, CASIO Computer Co., Ltd. shall not be liable for any claim of any kind whatsoever against the use of these materials by any other party.

- Be sure to keep all user documentation handy for future reference.
- The contents of this user's guide are subject to change without notice.
- No part of this user's guide may be reproduced in any form without the express written consent of the manufacturer.
- The options described in Chapter 17 of this user's guide may not be available in certain geographic areas. For full details on availability in your area, contact your nearest CASIO dealer or distributor.

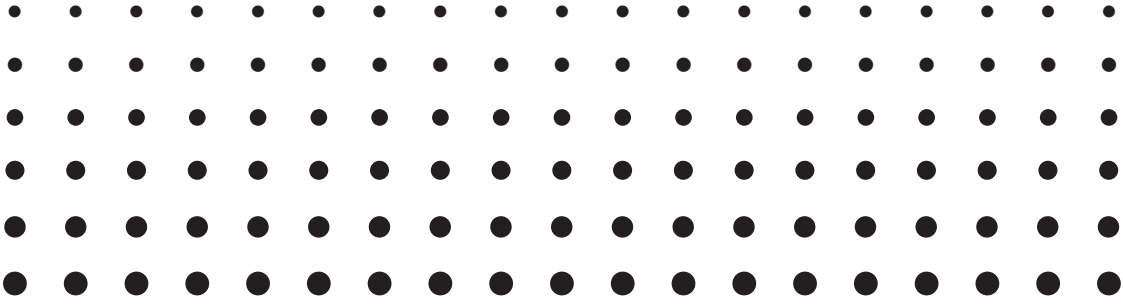

ClassPad 330

ClassPad OS Version 3.04

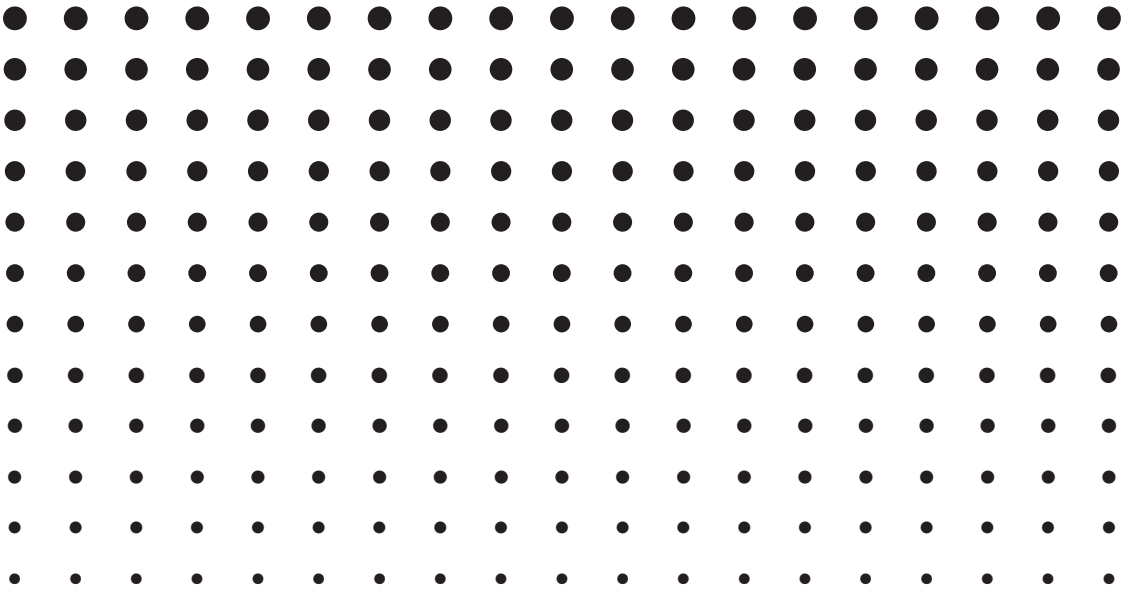



Contents

Getting Ready

- 1. Unpacking..... 1
- 2. Attaching and Removing the Front Cover 2
- 3. Using the Stylus 3
- 4. Replacing Batteries and Setting Up the ClassPad..... 3
- 5. User Registration 6
- Handling Precautions 7

About This User's Guide

- ClassPad Keypad and Icon Panel 0-1-1
- On-screen Keys, Menus, and Other Controllers 0-1-2
- Page Contents 0-1-3

Chapter 1 Getting Acquainted

- 1-1 General Guide 1-1-1**
 - General Guide 1-1-2
 - Using the Stylus 1-1-4
- 1-2 Turning Power On and Off 1-2-1**
 - Turning Power On 1-2-1
 - Turning Power Off 1-2-1
 - Resume Function 1-2-1
 - Limiting the Duration of the Sleep State 1-2-2
- 1-3 Using the Icon Panel 1-3-1**
- 1-4 Built-in Applications 1-4-1**
 - Starting a Built-in Application..... 1-4-2
 - Application Menu Operations 1-4-2
- 1-5 Built-in Application Basic Operations..... 1-5-1**
 - Application Window 1-5-1
 - Using a Dual Window Display 1-5-1
 - Using the Menu Bar 1-5-3
 - Using the  Menu 1-5-4
 - Using Check Boxes 1-5-6
 - Using Option Buttons..... 1-5-7
 - Using the Toolbar 1-5-8
 - Interpreting Status Bar Information 1-5-9
 - Pausing and Terminating an Operation 1-5-9
- 1-6 Input 1-6-1**
 - Using the Soft Keyboard 1-6-1
 - Input Basics 1-6-3
 - Advanced Soft Keyboard Operations 1-6-8











1-7 Variables and Folders	1-7-1
Folder Types.....	1-7-1
Variable Types	1-7-2
Creating a Folder	1-7-4
Creating and Using Variables.....	1-7-5
Assigning Values and Other Data to a System Variable	1-7-10
Locking a Variable or Folder.....	1-7-10
Rules Governing Variable Access	1-7-11
1-8 Using the Variable Manager	1-8-1
Variable Manager Overview	1-8-1
Starting Up the Variable Manager	1-8-1
Variable Manager Views.....	1-8-2
Exiting the Variable Manager	1-8-2
Variable Manager Folder Operations	1-8-3
Variable Operations.....	1-8-7
1-9 Configuring Application Format Settings.....	1-9-1
Specifying a Variable.....	1-9-2
Initializing All Application Format Settings.....	1-9-3
Application Format Settings.....	1-9-4

Chapter 2 Using the Main Application

2-1 Main Application Overview	2-1-1
Starting Up the Main Application	2-1-1
Main Application Window	2-1-1
Main Application Menus and Buttons	2-1-3
Using Main Application Modes	2-1-4
Accessing ClassPad Application Windows from the Main Application	2-1-5
Accessing the Main Application Window from Another ClassPad Application	2-1-6
2-2 Basic Calculations	2-2-1
Arithmetic Calculations and Parentheses Calculations	2-2-1
Using the (EXP) Key.....	2-2-2
Omitting the Multiplication Sign	2-2-2
Using the Answer Variable (ans)	2-2-2
Assigning a Value to a Variable.....	2-2-4
Calculation Error.....	2-2-4
Calculation Priority Sequence	2-2-5
Calculation Modes	2-2-6
2-3 Using the Calculation History.....	2-3-1
Viewing Calculation History Contents.....	2-3-1
Re-calculating an Expression	2-3-2
Deleting Part of the Calculation History Contents	2-3-4
Clearing All Calculation History Contents.....	2-3-4
2-4 Function Calculations.....	2-4-1
2-5 List Calculations	2-5-1
Inputting List Data.....	2-5-1
Using a List in a Calculation	2-5-3
Using a List to Assign Different Values to Multiple Variables	2-5-4



- 2-6 Matrix and Vector Calculations 2-6-1**
 - Inputting Matrix Data 2-6-1
 - Performing Matrix Calculations..... 2-6-4
 - Using a Matrix to Assign Different Values to Multiple Variables 2-6-6
- 2-7 Specifying a Number Base..... 2-7-1**
 - Number Base Precautions..... 2-7-1
 - Binary, Octal, Decimal, and Hexadecimal Calculation Ranges 2-7-1
 - Selecting a Number Base 2-7-3
 - Arithmetic Operations 2-7-4
 - Bitwise Operations..... 2-7-5
 - Using the baseConvert Function (Number System Transform)..... 2-7-5
- 2-8 Using the Action Menu 2-8-1**
 - Abbreviations and Punctuation Used in This Section 2-8-1
 - Example Screenshots..... 2-8-2
 - Displaying the Action Menu 2-8-3
 - Using the Transformation Submenu..... 2-8-3
 - Using the Advanced Submenu 2-8-8
 - Using the Calculation Submenu 2-8-12
 - Using the Complex Submenu..... 2-8-19
 - Using the List-Create Submenu 2-8-21
 - Using the List-Calculation Submenu 2-8-24
 - Using the Matrix-Create Submenu 2-8-31
 - Using the Matrix-Calculation Submenu 2-8-33
 - Using the Vector Submenu..... 2-8-38
 - Using the Equation/Inequality Submenu 2-8-42
 - Using the Assistant Submenu 2-8-47
 - Using the Distribution and Inv. Distribution Submenus 2-8-48
 - Using the Command Submenu 2-8-57
- 2-9 Using the Interactive Menu 2-9-1**
 - Interactive Menu and Action Menu 2-9-1
 - Interactive Menu Example 2-9-1
 - Using the “apply” Command..... 2-9-4
- 2-10 Using the Main Application in Combination with Other Applications 2-10-1**
 - Opening Another Application’s Window 2-10-1
 - Closing Another Application’s Window 2-10-2
 - Using the Graph Window  and 3D Graph Window  2-10-2
 - Using a Graph Editor Window (Graph & Table: , Conics: ,
3D Graph: , Numeric Solver: ) 2-10-4
 - Using the Stat Editor Window  2-10-5
 - Using the Geometry Window  2-10-9
 - Using the Sequence Editor Window  2-10-11
- 2-11 Using Verify 2-11-1**
 - Starting Up Verify 2-11-1
 - Verify Menus and Buttons 2-11-2
 - Using Verify 2-11-3



2-12 Using Probability 2-12-1
 Starting Up Probability 2-12-2
 Probability Menus and Buttons 2-12-2
 Using Probability 2-12-4

2-13 Running a Program in the Main Application 2-13-1

Chapter 3 Using the Graph & Table Application

3-1 Graph & Table Application Overview 3-1-1
 Starting Up the Graph & Table Application 3-1-1
 Graph & Table Application Window 3-1-1
 Graph & Table Application Menus and Buttons 3-1-2
 Graph & Table Application Status Bar 3-1-7
 Graph & Table Application Basic Operations 3-1-7

3-2 Using the Graph Window 3-2-1
 Configuring View Window Parameters for the Graph Window 3-2-1
 Viewing Graph Window Coordinates 3-2-5
 Scrolling the Graph Window 3-2-6
 Panning the Graph Window 3-2-6
 Zooming the Graph Window 3-2-7
 Other Graph Window Operations 3-2-10

3-3 Storing Functions 3-3-1
 Using Graph Editor Sheets 3-3-1
 Specifying the Function Type 3-3-2
 Storing a Function 3-3-3
 Using Built-in Functions 3-3-5
 Saving the Message Box Expression to the Graph Editor Window 3-3-5
 Editing Stored Functions 3-3-6
 Deleting All Graph Editor Expressions 3-3-7
 Graphing a Stored Function 3-3-7
 Saving Graph Editor Data to Graph Memory 3-3-14

3-4 Using Table & Graph 3-4-1
 Generating a Number Table 3-4-1
 Editing Number Table Values 3-4-4
 Deleting, Inserting, and Adding Number Table Lines 3-4-5
 Regenerating a Number Table 3-4-6
 Generating a Number Table and Using It to Draw a Graph 3-4-7
 Saving a Number Table to a List 3-4-8
 Generating a Summary Table 3-4-9
 Making the Graph Editor Window the Active Window 3-4-15

3-5 Modifying a Graph 3-5-1
 Modifying a Single Graph by Changing the Value of a Coefficient
 (Direct Modify) 3-5-1
 Simultaneously Modifying Multiple Graphs by Changing Common Variables
 (Dynamic Modify) 3-5-4

3-6 Using the Sketch Menu 3-6-1
 Sketch Menu Overview 3-6-1
 Using Sketch Menu Commands 3-6-1



3-7 Using Trace 3-7-1
 Using Trace to Read Graph Coordinates 3-7-1
 Linking Trace to a Number Table 3-7-3
 Generating Number Table Values from a Graph 3-7-4

3-8 Analyzing a Function Used to Draw a Graph 3-8-1
 G-Solve Menu Overview 3-8-1
 Using G-Solve Menu Commands 3-8-2

Chapter 4 Using the Conics Application

4-1 Conics Application Overview 4-1-1
 Starting Up the Conics Application 4-1-1
 Conics Application Window 4-1-1
 Conics Application Menus and Buttons 4-1-2
 Conics Application Status Bar 4-1-4

4-2 Inputting Equations 4-2-1
 Using a Conics Form to Input an Equation 4-2-1
 Inputting an Equation Manually 4-2-3
 Transforming a Manually Input Equation to a Conics Form 4-2-3

4-3 Drawing a Conics Graph 4-3-1
 Drawing a Parabola 4-3-1
 Drawing a Circle 4-3-4
 Drawing an Ellipse 4-3-5
 Drawing a Hyperbola 4-3-6
 Drawing a General Conics 4-3-8

4-4 Using Trace to Read Graph Coordinates 4-4-1
 Using Trace 4-4-1

4-5 Using G-Solve to Analyze a Conics Graph 4-5-1
 Displaying the G-Solve Menu 4-5-1
 Using G-Solve Menu Commands 4-5-2

Chapter 5 Using the 3D Graph Application

5-1 3D Graph Application Overview 5-1-1
 Starting Up the 3D Graph Application 5-1-1
 3D Graph Application Window 5-1-1
 3D Graph Application Menus and Buttons 5-1-2
 3D Graph Application Status Bar 5-1-4

5-2 Inputting an Expression 5-2-1
 Using 3D Graph Editor Sheets 5-2-1
 Storing a Function 5-2-2

5-3 Drawing a 3D Graph 5-3-1
 Configuring 3D Graph View Window Parameters 5-3-1
 3D Graph Example 5-3-3

5-4 Manipulating a Graph on the 3D Graph Window 5-4-1
 Enlarging and Reducing the Size of a Graph 5-4-1
 Switching the Eye Position 5-4-1
 Rotating the Graph Manually 5-4-2
 Rotating a Graph Automatically 5-4-3
 Initializing the Graph Window 5-4-3



5-5 Other 3D Graph Application Functions..... 5-5-1
 Using Trace to Read Graph Coordinates5-5-1
 Inserting Text into a 3D Graph Window.....5-5-1
 Calculating a z -value for Particular x - and y -values, or s - and t -values5-5-2
 Using Drag and Drop to Down a 3D Graph5-5-3

Chapter 6 Using the Sequence Application

6-1 Sequence Application Overview..... 6-1-1
 Starting up the Sequence Application6-1-1
 Sequence Application Window6-1-1
 Sequence Application Menus and Buttons6-1-2
 Sequence Application Status Bar6-1-6

6-2 Inputting an Expression in the Sequence Application..... 6-2-1
 Inputting Data on the Sequence Editor Window.....6-2-1
 Inputting Data on the Sequence RUN Window6-2-1

6-3 Recursive and Explicit Form of a Sequence 6-3-1
 Generating a Number Table6-3-1
 Graphing a Recursion.....6-3-3
 Determining the General Term of a Recursion Expression6-3-5
 Calculating the Sum of a Sequence6-3-6

6-4 Using LinkTrace 6-4-1

6-5 Drawing a Cobweb Diagram..... 6-5-1

Chapter 7 Using the Statistics Application

7-1 Statistics Application Overview..... 7-1-1
 Starting Up the Statistics Application.....7-1-2
 Stat Editor Window Menus and Buttons7-1-3
 Stat Editor Window Status Bar7-1-4

7-2 Using Stat Editor..... 7-2-1
 Basic List Operations.....7-2-1
 Inputting Data into a List.....7-2-4
 Editing List Contents.....7-2-7
 Sorting List Data7-2-8
 Controlling the Number of Displayed List Columns7-2-9
 Clearing All Stat Editor Data.....7-2-9

7-3 Before Trying to Draw a Statistical Graph..... 7-3-1
 Using the SetGraph Menu7-3-1
 Configuring StatGraph Setups.....7-3-2

7-4 Graphing Single-Variable Statistical Data..... 7-4-1
 Normal Probability Plot (NPPlot)7-4-1
 Histogram Bar Graph (Histogram)7-4-2
 Med-Box Plot (MedBox)7-4-2
 Normal Distribution Curve (NDist)7-4-3
 Broken Line Graph (Broken).....7-4-4



7-5 Graphing Paired-Variable Statistical Data.....	7-5-1
Drawing a Scatter Plot and xy Line Graph	7-5-1
Drawing a Regression Graph	7-5-2
Graphing Previously Calculated Regression Results	7-5-4
Drawing a Linear Regression Graph	7-5-5
Drawing a Med-Med Graph	7-5-6
Drawing Quadratic, Cubic, and Quartic Regression Graphs	7-5-7
Drawing a Logarithmic Regression Graph.....	7-5-9
Drawing an Exponential Regression Graph ($y = a \cdot e^{b \cdot x}$)	7-5-10
Drawing an Exponential Regression Graph ($y = a \cdot b^x$).....	7-5-11
Drawing a Power Regression Graph ($y = a \cdot x^b$)	7-5-12
Drawing a Sinusoidal Regression Graph ($y = a \cdot \sin(b \cdot x + c) + d$)	7-5-13
Drawing a Logistic Regression Graph ($y = \frac{c}{1 + a \cdot e^{-bx}}$)	7-5-14
Overlaying a Function Graph on a Statistical Graph	7-5-15
7-6 Using the Statistical Graph Window Toolbar	7-6-1
7-7 Performing Statistical Calculations.....	7-7-1
Viewing Single-variable Statistical Calculation Results	7-7-1
Viewing Paired-variable Statistical Calculation Results.....	7-7-2
Viewing Regression Calculation Results	7-7-3
Residual Calculation.....	7-7-3
Copying a Regression Formula to the Graph & Table Application	7-7-4
7-8 Test, Confidence Interval, and Distribution Calculations	7-8-1
Statistics Application Calculations	7-8-1
Program Application Calculations.....	7-8-1
7-9 Tests	7-9-1
Test Command List	7-9-2
7-10 Confidence Intervals.....	7-10-1
Confidence Interval Command List	7-10-2
7-11 Distributions	7-11-1
Distribution Command List	7-11-3
7-12 Statistical System Variables.....	7-12-1

Chapter 8 Using the Geometry Application

8-1 Geometry Application Overview.....	8-1-1
Starting Up the Geometry Application	8-1-3
Geometry Application Menus and Buttons	8-1-3
8-2 Drawing Figures	8-2-1
Using the Draw Menu	8-2-1
Inserting Text Strings into the Screen	8-2-18
Attaching an Angle Measurement to a Figure	8-2-19
Displaying the Measurements of a Figure	8-2-22
Displaying the Result of a Calculation that Uses On-screen Measurement Values.....	8-2-25
Using the Special Shape Submenu.....	8-2-27
Using the Construct Submenu.....	8-2-30
Transformation Using a Matrix or Vector (General Transform)	8-2-37



8-3 Editing Figures	8-3-1
Selecting and Deselecting Figures	8-3-1
Moving and Copying Figures	8-3-3
Pinning an Annotation on the Geometry Window	8-3-4
Specifying the Number Format of a Measurement	8-3-5
Using the Measurement Box	8-3-6
8-4 Controlling Geometry Window Appearance	8-4-1
Configuring View Window Settings	8-4-1
Selecting the Axis Setting	8-4-2
Toggling Integer Grid Display On and Off	8-4-3
Zooming	8-4-3
Using Pan to Shift the Display Image	8-4-6
8-5 Working with Animations	8-5-1
Using Animation Commands	8-5-1
8-6 Using the Geometry Application with Other Applications	8-6-1
Drag and Drop	8-6-1
Copy and Paste	8-6-5
Dynamically Linked Data	8-6-5
8-7 Managing Geometry Application Files	8-7-1
File Operations	8-7-1
Folder Operations	8-7-4

Chapter 9 Using the Numeric Solver Application

9-1 Numeric Solver Application Overview	9-1-1
Starting Up the Numeric Solver Application	9-1-1
Numeric Solver Application Window	9-1-1
Numeric Solver Menus and Buttons	9-1-1
9-2 Using Numeric Solver	9-2-1

Chapter 10 Using the eActivity Application

10-1 eActivity Application Overview	10-1-1
Starting Up the eActivity Application	10-1-1
eActivity Application Window	10-1-1
eActivity Application Menus and Buttons	10-1-2
eActivity Application Status Bar	10-1-4
eActivity Key Operations	10-1-4
10-2 Creating an eActivity	10-2-1
Basic Steps for Creating an eActivity	10-2-1
Managing eActivity Files	10-2-3
10-3 Inserting Data into an eActivity	10-3-1
Inserting a Text Row	10-3-1
Inserting a Calculation Row	10-3-3
Inserting an Application Data Strip	10-3-5
Strip Help Text	10-3-14
Moving Information Between eActivity and Applications	10-3-15
Inserting a Geometry Link Row	10-3-17



10-4 Working with eActivity Files.....	10-4-1
Opening an Existing eActivity	10-4-1
Browsing the Contents of an eActivity	10-4-2
Editing the Contents of an eActivity	10-4-2
Expanding an Application Data Strip	10-4-2
Modifying the Data in an Application Data Strip	10-4-3
Saving an Edited eActivity	10-4-3
10-5 Transferring eActivity Files	10-5-1
Transferring eActivity Files between Two ClassPad Units	10-5-1
Transferring eActivity Files between a ClassPad Unit and a Computer	10-5-2

Chapter 11 Using the Presentation Application

11-1 Presentation Application Overview.....	11-1-1
Starting Up the Presentation Application.....	11-1-2
Presentation Application Window	11-1-2
Presentation Application Menus and Buttons	11-1-3
Screen Capture Precautions	11-1-4
11-2 Building a Presentation.....	11-2-1
Adding a Blank Page to a Presentation.....	11-2-2
11-3 Managing Presentation Files	11-3-1
11-4 Playing a Presentation.....	11-4-1
Using Auto Play.....	11-4-1
Using Manual Play.....	11-4-2
Using Repeat Play.....	11-4-3
11-5 Editing Presentation Pages.....	11-5-1
About the Editing Tool Palette	11-5-1
Entering the Editing Mode	11-5-1
Editing Operations	11-5-3
Using the Eraser.....	11-5-7
11-6 Configuring Presentation Preferences	11-6-1
11-7 Presentation File Transfer	11-7-1

Chapter 12 Using the Program Application

12-1 Program Application Overview.....	12-1-1
Starting Up the Program Application	12-1-1
Program Loader Window.....	12-1-1
Program Editor Window.....	12-1-3
12-2 Creating a New Program	12-2-1
General Programming Steps	12-2-1
Creating and Saving a Program	12-2-1
Running a Program	12-2-5
Pausing Program Execution	12-2-6
Terminating Program Execution	12-2-6
Configuring Parameter Variables and Inputting Their Values	12-2-7
Using Subroutines	12-2-8



12-3 Debugging a Program	12-3-1
Debugging After an Error Message Appears.....	12-3-1
Debugging a Program Following Unexpected Results	12-3-1
Modifying an Existing Program to Create a New One	12-3-2
Searching for Data Inside a Program	12-3-5
12-4 Managing Files	12-4-1
Renaming a File	12-4-1
Deleting a Program.....	12-4-1
Changing the File Type	12-4-2
12-5 User-defined Functions	12-5-1
Creating a New User-defined Function	12-5-1
Executing a User-defined Function	12-5-3
Editing a User-defined Function	12-5-4
Deleting a User-defined Function	12-5-4
12-6 Program Command Reference	12-6-1
Using This Reference	12-6-1
Program Application Commands.....	12-6-2
Application Command List.....	12-6-15
12-7 Including ClassPad Functions in Programs	12-7-1
Including Graphing Functions in a Program	12-7-1
Using Conics Functions in a Program	12-7-1
Including 3D Graphing Functions in a Program.....	12-7-2
Including Table & Graph Functions in a Program.....	12-7-2
Including Recursion Table and Recursion Graph Functions in a Program.....	12-7-3
Including List Sort Functions in a Program.....	12-7-3
Including Statistical Graphing and Calculation Functions in a Program	12-7-4

Chapter 13 Using the Spreadsheet Application

13-1 Spreadsheet Application Overview	13-1-1
Starting Up the Spreadsheet Application.....	13-1-1
Spreadsheet Window	13-1-1
13-2 Spreadsheet Application Menus and Buttons	13-2-1
13-3 Basic Spreadsheet Window Operations	13-3-1
About the Cell Cursor	13-3-1
Controlling Cell Cursor Movement.....	13-3-1
Navigating Around the Spreadsheet Window	13-3-2
Hiding or Displaying the Scrollbars.....	13-3-4
Selecting Cells.....	13-3-5
Using the Cell Viewer Window	13-3-6
13-4 Editing Cell Contents	13-4-1
Edit Mode Screen	13-4-1
Entering the Edit Mode	13-4-2
Basic Data Input Steps	13-4-3
Inputting a Formula.....	13-4-4
Inputting a Cell Reference	13-4-6
Inputting a Constant	13-4-8
Using the Fill Sequence Command	13-4-9
Cut and Copy.....	13-4-11



Paste	13-4-11
Specifying Text or Calculation as the Data Type for a Particular Cell	13-4-13
Using Drag and Drop to Copy Cell Data within a Spreadsheet	13-4-14
Using Drag and Drop to Obtain Spreadsheet Graph Data	13-4-16
Recalculating Spreadsheet Expressions	13-4-17
Importing and Exporting Variable Values	13-4-21
Searching for Data in a Spreadsheet	13-4-26
Sorting Spreadsheet Data	13-4-29
13-5 Using the Spreadsheet Application with the eActivity	
Application.....	13-5-1
Drag and Drop	13-5-1
13-6 Statistical Calculations.....	13-6-1
13-7 Cell and List Calculations	13-7-1
Spreadsheet [List-Calculation] Submenu Basics.....	13-7-1
Cell Calculation and List Calculation Functions.....	13-7-4
13-8 Formatting Cells and Data.....	13-8-1
Standard (Fractional) and Decimal (Approximate) Modes	13-8-1
Plain Text and Bold Text	13-8-1
Text and Calculation Data Types	13-8-1
Text Alignment.....	13-8-2
Number Format	13-8-2
Changing the Width of a Column.....	13-8-3
13-9 Graphing	13-9-1
Graph Menu.....	13-9-1
Graph Window Menus and Toolbar	13-9-11
Basic Graphing Steps.....	13-9-13
Regression Graph Operations.....	13-9-15
Other Graph Window Operations	13-9-16

Chapter 14 Using the Differential Equation Graph Application

14-1 Differential Equation Graph Application Overview.....	14-1-1
Differential Equation Graph Application Features	14-1-1
Starting Up the Differential Equation Graph Application.....	14-1-2
Differential Equation Graph Application Window.....	14-1-2
Differential Equation Editor Window Menus and Buttons	14-1-4
Differential Equation Graph Window Menus and Buttons	14-1-6
Differential Equation Graph Application Status Bar.....	14-1-8
14-2 Graphing a First Order Differential Equation.....	14-2-1
Inputting a First Order Differential Equation and Drawing a Slope Field	14-2-1
Inputting Initial Conditions and Graphing the Solution Curves of a First Order Differential Equation	14-2-3
Configuring Solution Curve Graph Settings.....	14-2-4
14-3 Graphing a Second Order Differential Equation	14-3-1
Drawing the Phase Plane of a Second Order Differential Equation	14-3-1
Inputting Initial Conditions and Graphing the Solution Curve of a Second Order Differential Equation.....	14-3-2
14-4 Graphing an Nth-order Differential Equation	14-4-1
Inputting an Nth-order Differential Equation and Initial Conditions, and then Graphing the Solutions	14-4-1



14-5 Drawing $f(x)$ Type Function Graphs and Parametric Function Graphs.....	14-5-1
Drawing an $f(x)$ Type Function Graph	14-5-1
Drawing a Parametric Function Graph	14-5-2
14-6 Configuring Differential Equation Graph View Window Parameters.....	14-6-1
Configuring Differential Equation Graph View Window Settings	14-6-1
Differential Equation Graph View Window Parameters	14-6-2
14-7 Differential Equation Graph Window Operations	14-7-1
Graph Zooming and Scrolling	14-7-1
Configuring and Modifying Initial Conditions	14-7-1
Using Trace to Read Graph Coordinates	14-7-5
Graphing an Expression or Value by Dropping it into the Differential Equation Graph Window.....	14-7-6

Chapter 15 Using the Financial Application

15-1 Financial Application Overview	15-1-1
Starting Up the Financial Application.....	15-1-1
Financial Application Menus and Buttons.....	15-1-2
Configuring Default Financial Application Settings.....	15-1-4
Financial Application Pages	15-1-5
Financial Calculation Screen Basics	15-1-6
Variables.....	15-1-7
15-2 Simple Interest	15-2-1
Simple Interest Fields	15-2-1
Financial Application Default Setup for Examples.....	15-2-1
Calculation Formulas.....	15-2-2
15-3 Compound Interest	15-3-1
Compound Interest Fields	15-3-1
Financial Application Default Setup for Examples.....	15-3-1
Calculation Formulas.....	15-3-3
15-4 Cash Flow	15-4-1
Cash Flow Fields	15-4-1
Inputting Cash Flow Values.....	15-4-1
Calculation Formulas.....	15-4-4
15-5 Amortization	15-5-1
Amortization Fields	15-5-1
Financial Application Default Setup for Examples.....	15-5-1
Calculation Formulas.....	15-5-4
15-6 Interest Conversion.....	15-6-1
Interest Conversion Fields.....	15-6-1
Calculation Formulas.....	15-6-2
15-7 Cost/Sell/Margin.....	15-7-1
Cost/Sell/Margin Fields	15-7-1
Calculation Formulas.....	15-7-1



15-8 Day Count	15-8-1
Day Count Fields	15-8-1
Financial Application Default Setup for Examples	15-8-1
15-9 Depreciation	15-9-1
Depreciation Fields	15-9-1
Calculation Formulas	15-9-3
15-10 Bond Calculation	15-10-1
Bond Calculation Fields.....	15-10-1
Financial Application Default Setup for Examples	15-10-1
Calculation Formulas	15-10-4
15-11 Break-Even Point	15-11-1
Break-Even Point Fields	15-11-1
Financial Application Default Setup for Examples	15-11-1
Calculation Formulas	15-11-3
15-12 Margin of Safety	15-12-1
Margin of Safety Fields.....	15-12-1
Calculation Formulas	15-12-1
15-13 Operating Leverage	15-13-1
Operating Leverage Fields	15-13-1
Calculation Formulas	15-13-1
15-14 Financial Leverage	15-14-1
Financial Leverage Fields.....	15-14-1
Calculation Formulas	15-14-1
15-15 Combined Leverage	15-15-1
Combined Leverage Fields.....	15-15-1
Calculation Formulas	15-15-1
15-16 Quantity Conversion	15-16-1
Quantity Conversion Fields	15-16-1
Calculation Formulas	15-16-2

Chapter 16 Configuring System Settings

16-1 System Setting Overview	16-1-1
Starting Up the System Application	16-1-1
System Application Window	16-1-1
System Application Menus and Buttons	16-1-2
16-2 Managing Memory Usage	16-2-1
Memory Usage Sheets	16-2-1
Deleting Memory Usage Data	16-2-3
16-3 Using the Reset Dialog Box	16-3-1
16-4 Initializing Your ClassPad	16-4-1
16-5 Adjusting Display Contrast	16-5-1
16-6 Configuring Power Properties	16-6-1
Power Saving Mode	16-6-1
Auto Power Off	16-6-1
Configuring Power Properties.....	16-6-2
16-7 Specifying the Display Language	16-7-1



16-8	Specifying the Font Set	16-8-1
16-9	Specifying the Alphabetic Keyboard Arrangement	16-9-1
16-10	Optimizing “Flash ROM”	16-10-1
16-11	Specifying the Ending Screen Image	16-11-1
16-12	Adjusting Touch Panel Alignment	16-12-1
16-13	Viewing Version Information	16-13-1
16-14	Registering a User Name on a ClassPad	16-14-1
16-15	Specifying the Complex Number Imaginary Unit.....	16-15-1
16-16	Assigning Shift Mode Key Operations to Hard Keys.....	16-16-1

Chapter 17 Performing Data Communication

17-1	Data Communication Overview	17-1-1
	Connectable Devices and Transferable Data	17-1-1
	Using the ClassPad Communication Application	17-1-3
17-2	Connecting the ClassPad to Another Device	17-2-1
	Connecting to Another ClassPad Unit	17-2-1
	Connecting to an EA-200 Data Analyzer.....	17-2-2
	Connecting to a Computer (USB).....	17-2-3
17-3	Configuring Communication Parameters	17-3-1
	Wakeup	17-3-2
17-4	Transferring Data to Another ClassPad Unit	17-4-1
	Selecting Data for Transfer.....	17-4-3
	Sending a Screenshot of the Current Display Contents	17-4-5
	Communication Standby	17-4-6
	Interrupting an Ongoing Data Communication Operation	17-4-6

Appendix

1	Resetting and Initializing the ClassPad	α-1-1
2	Deleting an Application	α-2-1
3	Power Supply.....	α-3-1
4	Number of Digits and Precision.....	α-4-1
5	Specifications.....	α-5-1
6	Character Code Table.....	α-6-1
7	System Variable Table	α-7-1
8	Command and Function Index.....	α-8-1
9	Graph Types and Executable Functions	α-9-1
10	Error Message Table	α-10-1

About This User's Guide

This section explains the symbols that are used in this user's guide to represent keys, stylus operations, display elements, and other items you encounter while operating your ClassPad.

ClassPad Keypad and Icon Panel

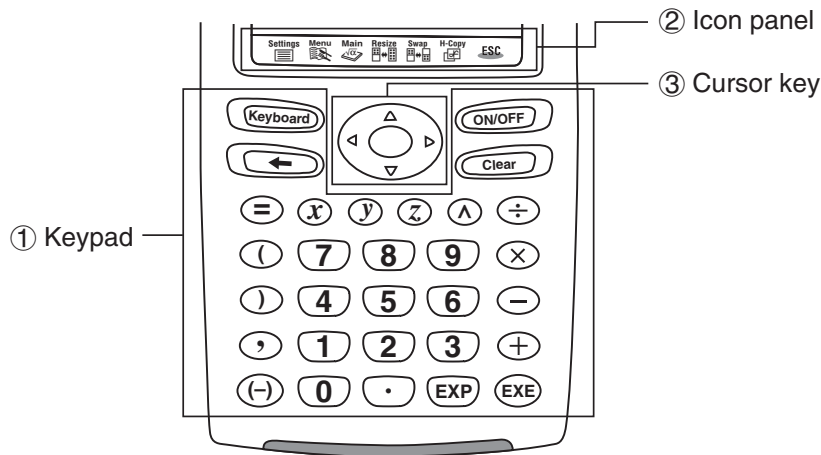

① Keypad

ClassPad keypad keys are represented by illustrations that look like the keys you need to press.

Example 1: Key within text

Press the **Keyboard** to show the soft keyboard.

Example 2: A series of key operations

Clear **2** **+** **3** **-** **4** **+** **1** **0** **EXE**

When you see something like the above, simply press the keys in the indicated sequence, from left to right.

② Icon panel

An operation that requires tapping an icon on the icon panel is indicated by an illustration of the icon.

Example 1: Tap **Menu** to display the application menu.

Example 2: Tap **ESC** to cancel an ongoing operation.

③ Cursor key

Operation of the cursor key is represented by arrow buttons that indicate which part of the cursor key you need to press: **▲**, **▼**, **◀**, **▶**.

Example 1: Use **◀** or **▶** to move the cursor around the display.

Example 2: **◀◀◀◀**

The above example means that you should press **◀** four times.



On-screen Keys, Menus, and Other Controllers

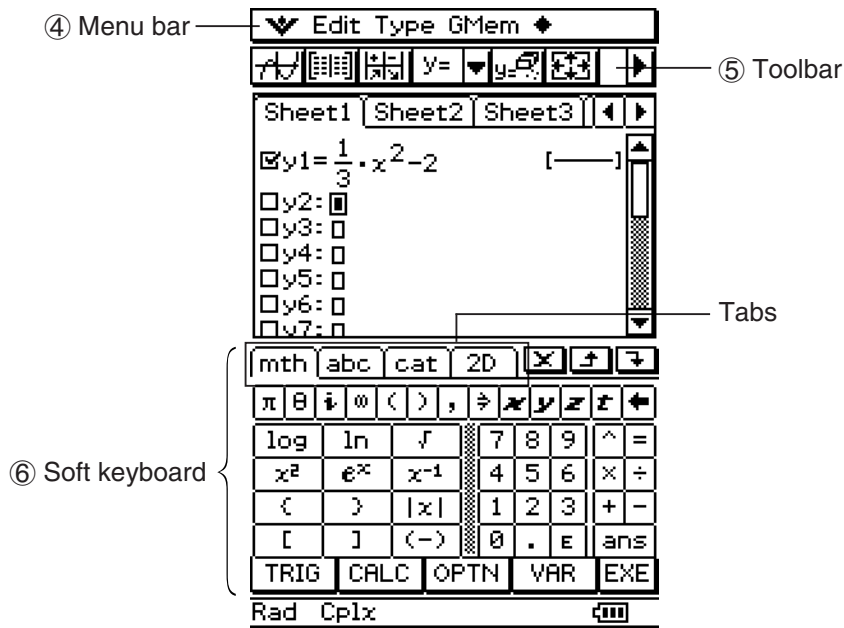

④ Menu bar

Menu names and commands are indicated in text by enclosing them inside of brackets. The following examples show typical menu operations.

Example 1: Tap the menu and then tap [Keyboard].

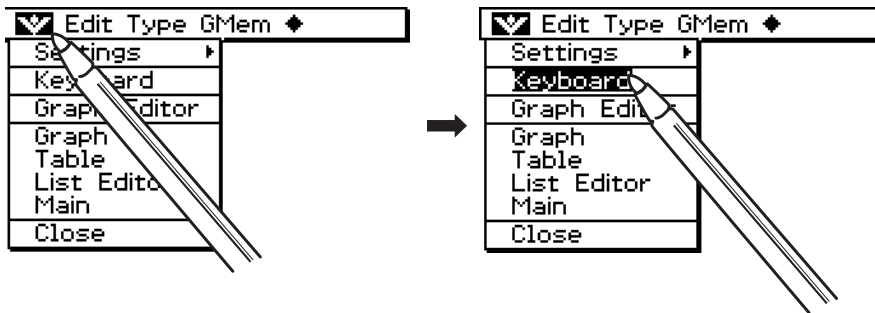

Example 2: Tap [Analysis], [Sketch], and then [Line].

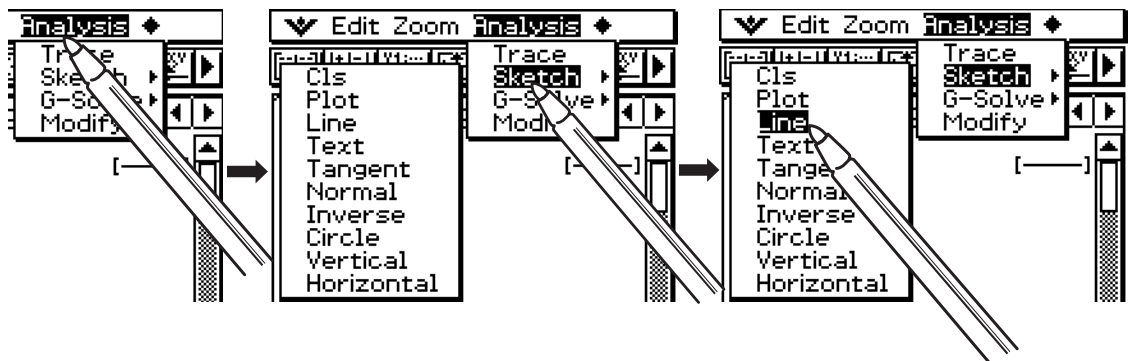



⑤ Toolbar

Toolbar button operations are indicated by illustrations that look like the button you need to tap.

Example 1: Tap  to graph the functions.

Example 2: Tap  to open the Stat Editor window.

⑥ Soft keyboard



Key operations on the soft keyboards that appear when you press the  key are indicated by illustrations that look like the keyboard keys.

You can change from one keyboard type to another by tapping one of the tabs along the top of the soft keyboard.

Example 1:      

Example 2:        



Important!

- If a procedure in this User's Guide requires use of a soft keyboard, press the  key to display the soft keyboard. The  key operation is not included as one of the procedure steps. For more details about how to input data on the ClassPad, see "1-6 Input".

Page Contents

Three-part page numbers are centered at the top of each page. The page number "1-4-2", for example, indicates Chapter 1, Section 4, page 2.



















1-4-2
Built-in Applications

To perform this type of operation:	Select this icon:	See Chapter:
<ul style="list-style-type: none"> • Exchange data with another ClassPad, a computer, or another device. 		17
<ul style="list-style-type: none"> • Clear the memory • Adjust contrast • Configure other system settings 		16

Starting a Built-in Application
Perform the steps below to start a built-in application.

- **ClassPad Operation**
 - (1) On the icon panel, tap  to display the application menu.

MENU

Application Menu
 - (2) If you cannot see the icon of the application you want on the menu, tap the scroll buttons or drag the scroll bar to bring other icons into view.
 - (3) Tap an icon to start the application.

Tip
* You can also start the Main application by tapping  on the icon panel. See "1-3 Using the Icon Panel" for details.

Application Menu Operations
The following describes the various types of operations you can perform while the application menu is on the display.

- Starting an application
See "Starting a Built-in Application" above.

Note

Display examples shown in this User's Guide are intended for illustrative purposes only. The text, values, menus and buttons shown in the screen shots, and other details shown in this User's Guide may be slightly different from what actually appears on your ClassPad screen.

Chapter

1

1

Getting Acquainted

- 1-1 General Guide**
- 1-2 Turning Power On and Off**
- 1-3 Using the Icon Panel**
- 1-4 Built-in Applications**
- 1-5 Built-in Application Basic Operations**
- 1-6 Input**
- 1-7 Variables and Folders**
- 1-8 Using the Variable Manager**
- 1-9 Configuring Application Format Settings**



1-1 General Guide

Front

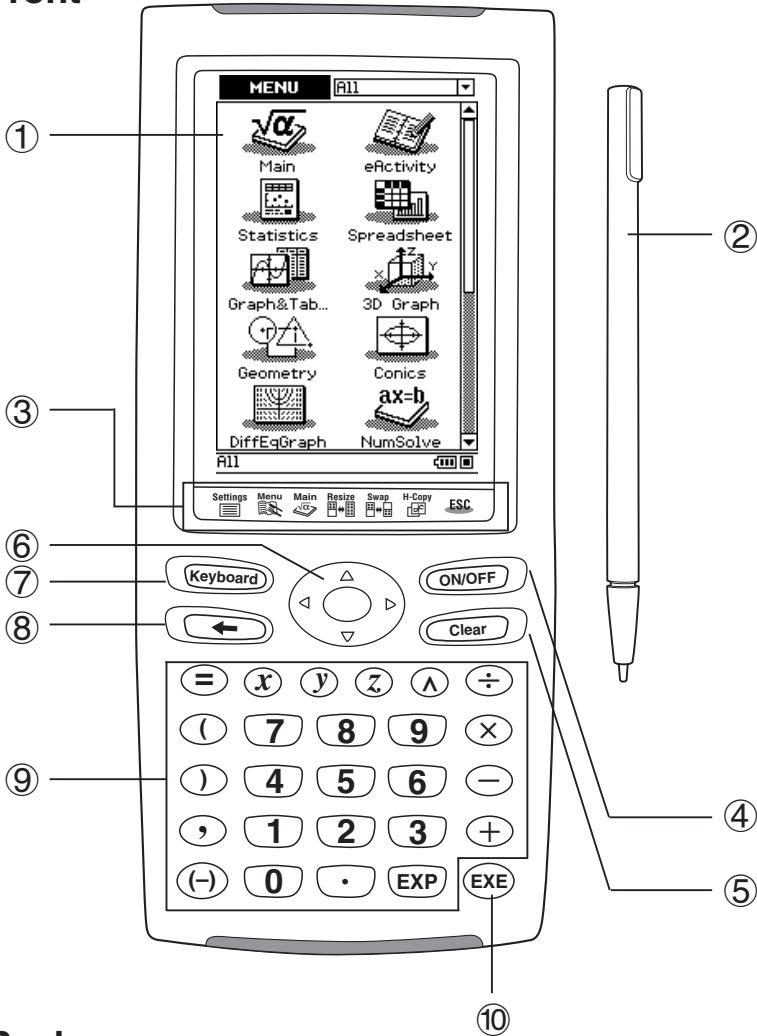

Side

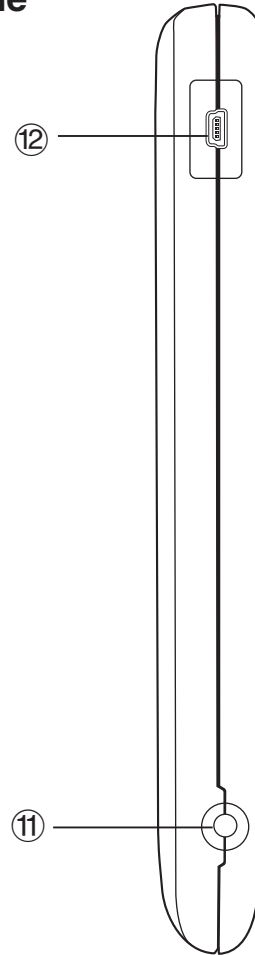

Back

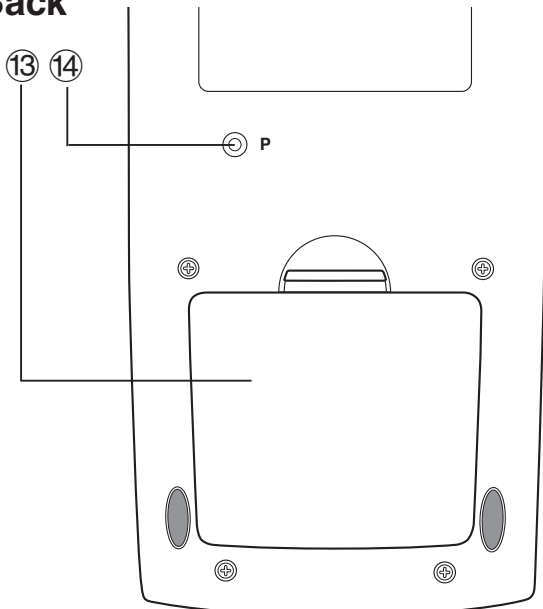



General Guide

The numbers next to each of the items below correspond to the numbers in the illustration on page 1-1-1.

Front

① Touch screen

The touch screen shows calculation formulas, calculation results, graphs and other information. The stylus that comes with the ClassPad can be used to input data and perform other operations by tapping directly on the touch screen.

② Stylus

This stylus is specially designed for performing touch screen operations. The stylus slips into a holder on the right side of the ClassPad for storage when it is not in use. For more information, see “Using the Stylus” on page 1-1-4.

③ Icon panel

Tapping an icon executes the function assigned to it. See “1-3 Using the Icon Panel” for details.

④ key

Press this key to toggle ClassPad power on and off. See “1-2 Turning Power On and Off” for details.

⑤ key

- Pressing this key while inputting data clears all of the data you have input up to that point. For details, see “Input Basics” on page 1-6-3.
- Pressing the  key while a calculation operation is in progress interrupts the calculation. For details, see “Pausing and Terminating an Operation” on page 1-5-9.

⑥ Cursor key ()

Use the cursor key to move the text cursor, selection highlighting, and other selection tools around the display.

⑦ key

Press this key to toggle display of the soft keyboard on and off. For details, see “Using the Soft Keyboard” on page 1-6-1.

⑧ key

- Pressing this key while inputting numeric, expression, or text data deletes one character to the left of the current cursor position. For details, see “Input Basics” on page 1-6-3.
- Pressing the  key while a calculation operation is in progress pauses the calculation. For details, see “Pausing and Terminating an Operation” on page 1-5-9.



⑨ Keypad

Use these keys to input the values and operators marked on them. See “1-6 Input” for details.

⑩ key

Press this key to execute a calculation operation or enter a return.

Side

⑪ 3-pin data communication port

Connect the data communication cable here to communicate with another ClassPad unit or a CASIO Data Analyzer. See “Chapter 17 – Performing Data Communication” for details.

⑫ 4-pin mini USB port

Connect the data communication cable here to exchange data with a computer. See “Chapter 17 – Performing Data Communication” for details.

Back

⑬ Battery compartment

Holds the four AAA-size batteries that power the ClassPad. For details, see “Power Supply” on page α -3-1.

⑭ P button

Press this button to reset the ClassPad. For details, see “Performing the RAM Reset Operation” on page α -1-2.



Using the Stylus

Most value and formula input, command executions, and other operations can be performed using the stylus.

■ Things you can do with the stylus

<p>Tap</p>	<ul style="list-style-type: none"> • This is equivalent to clicking with a mouse. • To perform a tap operation, tap lightly with the stylus on the ClassPad's touch screen. • Tapping is used to display a menu, execute an on-screen button operation, make a window active, etc. 	
<p>Drag</p>	<ul style="list-style-type: none"> • This is equivalent to dragging with a mouse. • To perform a drag operation, hold the tip of the stylus on the touch screen as you move the stylus to another location. • Dragging is used to change the setting of a slider or some other on-screen controller, to move a formula, etc. 	

Important!

- Be sure that you do not misplace or lose the stylus. Keep the stylus in the holder on the right side of the ClassPad whenever you are not using it.
- Do not allow the tip of the stylus to become damaged. Using a stylus with a damaged tip to perform touch screen operations can damage the touch screen.
- Use only the stylus that comes with your ClassPad or some other similar instrument to perform touch screen operations. Never use a pen, pencil or other writing instrument, which can damage the touch screen.



1-2 Turning Power On and Off

Turning Power On

You can turn on the ClassPad either by pressing the  key or by tapping the touch screen with the stylus.

- Turning on the ClassPad (while it is in the sleep state) displays the window that was on the display when you last turned it off. See “Resume Function” below.
- Note that you need to perform a few initial setup operations when you turn on the ClassPad the first time after purchasing it. For details, see “Getting Ready” at the beginning of this user’s guide (page 1).

Turning Power Off

To turn off the ClassPad, hold down the  key for about two seconds, or until the ending screen appears. For details about the ending screen, see “16-11 Specifying the Ending Screen Image”.

Important!

The ClassPad also has an Auto Power Off feature. This feature automatically turns the ClassPad off when it is idle for a specified amount of time. For details, see “Auto Power Off” on page 16-6-1.

Though the screen of your ClassPad goes blank when you turn it off, it continues to perform certain internal processes for a short while. Because of this, you should always wait for a minute or so after turning off the ClassPad before turning it back on again.

Resume Function

Any time the ClassPad powers down (because you turn off power or because of Auto Power Off), the Resume function automatically backs up its current operational status and any data in RAM, and the ClassPad enters a “sleep state”. If you turn ClassPad power back on while it is in the sleep state, the Resume function restores the backed up operational status and RAM data.



Limiting the Duration of the Sleep State

You can use the [Power Save Mode] setting (page 16-6-1) to limit the duration of the sleep state that is entered by the Resume function. If you have “1 day” specified for [Power Save Mode], for example, the ClassPad remains in the sleep state for one day after power is turned off. After that, the ClassPad powers down completely, which deletes all data that was backed up by the Resume function.

The following describes the difference between powering up from the sleep state and powering up after the ClassPad powers down completely.

■ Powering Up from the Sleep State

Power comes on immediately, with all data backed up by the Resume function restored.

■ Powering Up after Complete Power Down

1. Press the **ON/OFF** key or tap the ClassPad screen.
 - This causes the ClassPad to perform its startup routine, which takes a little time to complete.
2. The application menu will appear after you finish the touch panel alignment procedure.

Tip









- See “16-6 Configuring Power Properties” for information about changing the [Power Save Mode] setting.



1-3 Using the Icon Panel

The icon panel of seven permanent icons is located below the touch screen. Tapping an icon executes the function assigned to it. The table below explains what you can do with the icon panel icons.

Function

When you want to do this:	Tap this icon:
Display the  menu to configure settings, switch to the application menu, etc. See “Using the  Menu” on page 1-5-4.	Settings 
Display the application menu See “1-4 Built-in Applications” for details.	Menu 
Start the Main application See “Chapter 2 – Using the Main Application” for details.	Main 
Resize the currently active window (when there are two windows displayed) so it fills the entire display, or return to the dual window display again See “Using a Dual Window Display” on page 1-5-1.	Resize 
Swap the upper window and lower window (when there are two windows displayed) See “Using a Dual Window Display” on page 1-5-1.	Swap 
Capture the currently displayed screen for transfer to a computer or for use with the ClassPad’s presentation application See “Chapter 11 – Using the Presentation Application” and “Chapter 17 – Performing Data Communication”.	H-Copy 
Perform the same operation as a computer’s ESC key The actual operation performed when this icon is tapped depends on the application you are currently using.	ESC 

Tip

Tapping the  icon while the application menu is on the screen will display a menu that you can use to perform the following operations.















- Move an icon (page 1-4-3)
- Swap two icons (page 1-4-4)
- Adjust touch panel alignment (page 1-4-4)



1-4 Built-in Applications

Tapping  on the icon panel displays the application menu.

The table below shows the icon menu names of the built-in applications, and explains what you can do with each application.

To perform this type of operation:	Select this icon:	See Chapter:
<ul style="list-style-type: none"> • General calculations, including function calculations • Matrix calculations • Computer Algebra System 	 Main	2
<ul style="list-style-type: none"> • Access the eActivity function 	 eActivity	10
<ul style="list-style-type: none"> • Create a list • Perform statistical calculations • Draw a statistical graph 	 Statistics	7
<ul style="list-style-type: none"> • Input data into a spreadsheet • Manipulate spreadsheet data • Graph spreadsheet data 	 Spreadsheet	13
<ul style="list-style-type: none"> • Register a function and create a table of solutions by substituting different values for the function's variables • Draw a graph 	 Graph&Tab...	3
<ul style="list-style-type: none"> • Graph the 3D function $z = f(x,y)$ 	 3D Graph	5
<ul style="list-style-type: none"> • Draw geometric figures • Build animated figures 	 Geometry	8
<ul style="list-style-type: none"> • Draw the graph of a conics section 	 Conics	4
<ul style="list-style-type: none"> • Draw vector fields and solution curves to explore differential equations 	 DiffEqGraph	14
<ul style="list-style-type: none"> • Obtain the value of any variable in an equation, without transforming or simplifying the equation 	 NumSolve	9
<ul style="list-style-type: none"> • Perform sequence calculations • Solve recursion expressions 	 Sequence	6
<ul style="list-style-type: none"> • Perform simple interest, compound interest, and other financial calculations 	 Financial	15
<ul style="list-style-type: none"> • Register a file name in the programming area • Input a program or run a program 	 Program	12
<ul style="list-style-type: none"> • Create and run a presentation using ClassPad application window 	 Presentati...	11



To perform this type of operation:	Select this icon:	See Chapter:
<ul style="list-style-type: none"> • Exchange data with another ClassPad, a computer, or another device 	 Communica...	17
<ul style="list-style-type: none"> • Clear the memory • Adjust contrast • Configure other system settings 	 System	16

Starting a Built-in Application

Perform the steps below to start a built-in application.

• ClassPad Operation

(1) On the icon panel, tap  to display the application menu.

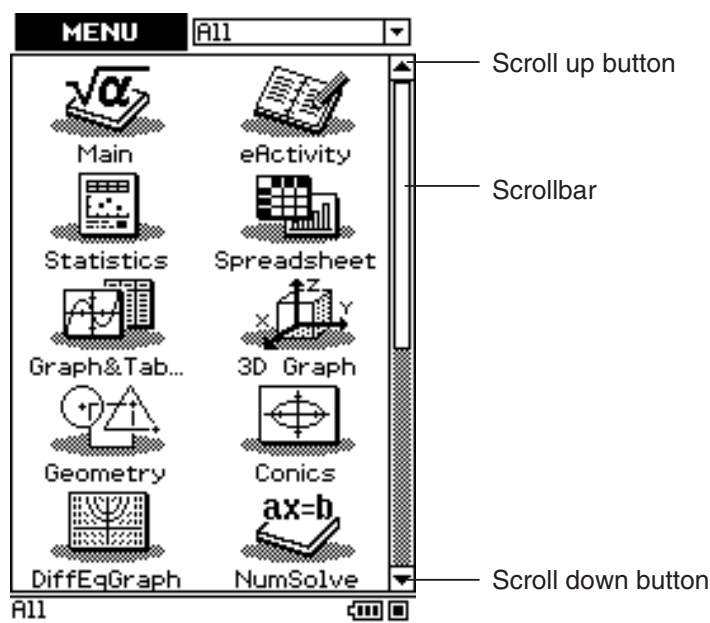

Application Menu

(2) If you cannot see the icon of the application you want on the menu, tap the scroll buttons or drag the scroll bar to bring other icons into view.

(3) Tap an icon to start its application.

Tip

- You can also start the Main application by tapping  on the icon panel. See “1-3 Using the Icon Panel” for details.

Application Menu Operations

The following describes the various types of operations you can perform while the application menu is on the display.

- Starting an application
See “Starting a Built-in Application” above.



- Displaying applications according to group (Additional Applications, All Applications)
See “Using Application Groups” below.
- Moving or swapping icons
See “Moving an Icon” below, and “Swapping Two Icons” on page 1-4-4.
- Deleting an application
See “Deleting an Application” on page α-2-1.

■ Using Application Groups

You can use application groups to specify the type of applications that appear on the application menu.

To select an application group, tap the box in the upper right of the application menu, and then select the group you want from the list that appears.

To display these icons:	Select this application group:
Add-in applications only	Additional
All applications	All
Add-in applications above built-in applications	Add-ins First

Tip

- Nothing appears on the application menu if you select the “Additional” group while there are no add-in applications installed on the ClassPad.

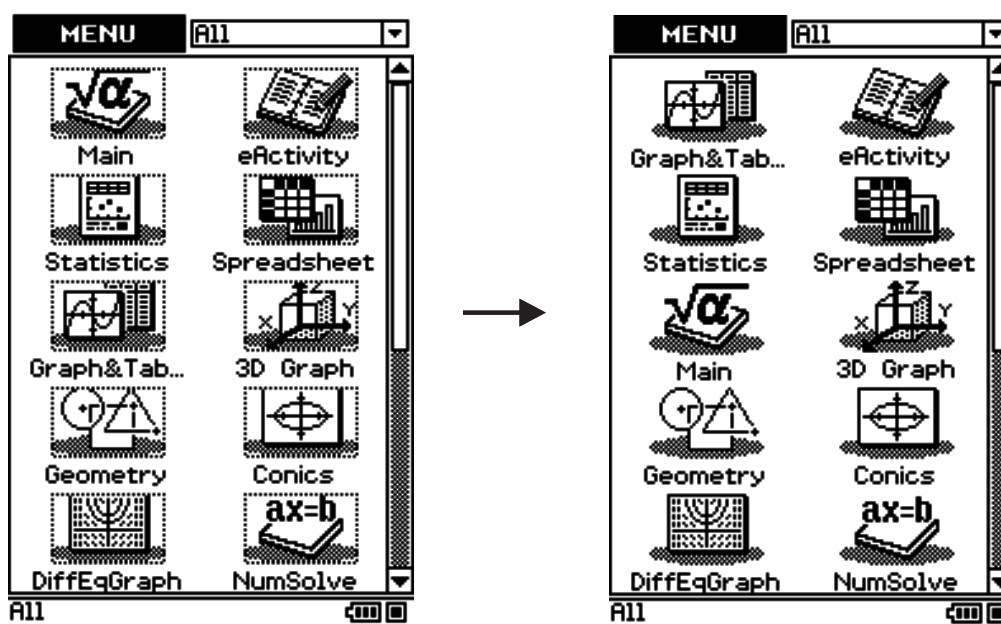

■ Moving an Icon

You can use the procedure below to move an icon to a different location on the application menu.





• ClassPad Operation

- (1) On the icon panel, tap  to display the application menu.
- (2) Tap **MENU** at the top left of the application menu.
 - This opens a menu of setting options.
- (3) Tap [Move Icon].
- (4) Tap the icon you want to move ( in this example).
 - This selects the icon.
- (5) Tap the icon that you want the first icon to follow ( in this example).
 - This moves the icon.

■ Swapping Two Icons

Perform the following steps to swap two icons on the application menu.

• ClassPad Operation

- (1) On the icon panel, tap  to display the application menu.
- (2) Tap **MENU** at the top left of the application menu.
 - This opens a menu of setting options.
- (3) Tap [Swap Icon].
- (4) Tap one of the icons.
 - This selects the icon.
- (5) Tap the other icon (the one you want to swap with).
 - This swaps the icons.

■ Adjusting Touch Panel Alignment

Perform the following steps to align the touch panel.

• ClassPad Operation

- (1) On the icon panel, tap  to display the application menu.
- (2) Tap **MENU** at the top left of the application menu.
 - This opens a menu of setting options.
- (3) Tap [Touch Panel Alignment].
 - This displays the Touch Panel Alignment screen.
- (4) Use the stylus to tap the center of each of the four crosses as they appear on the screen.
 - Tapping the center of the fourth cross completes touch panel alignment and returns you to the application menu.
 - When aligning your ClassPad try to tap the exact center of each cross.



1-5 Built-in Application Basic Operations

This section explains basic information and operations that are common to all of the built-in applications.

Application Window

The following shows the basic configuration of a built-in application window.

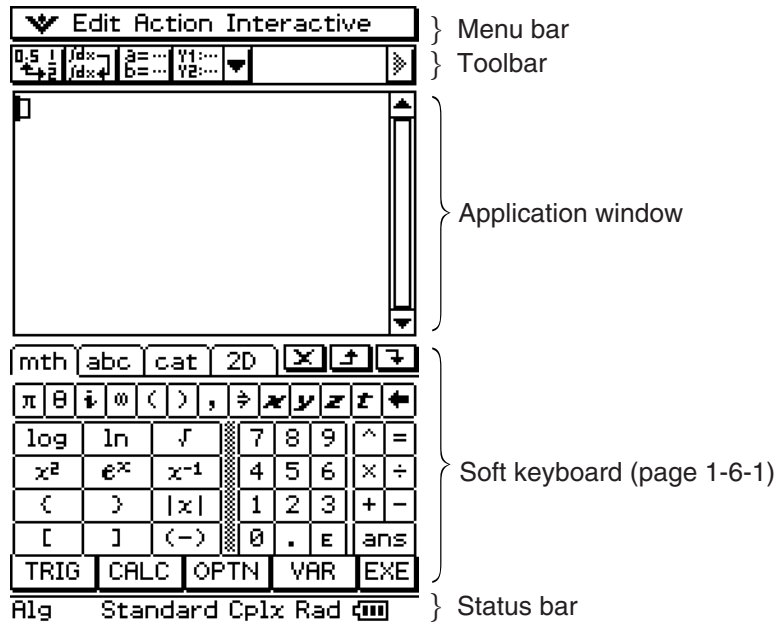

Using a Dual Window Display

Many applications split the display between an upper window and a lower window, each of which shows different information. The sample screenshot below is from the Conics application, which uses the upper window for input of expressions, and the lower window for graphing.

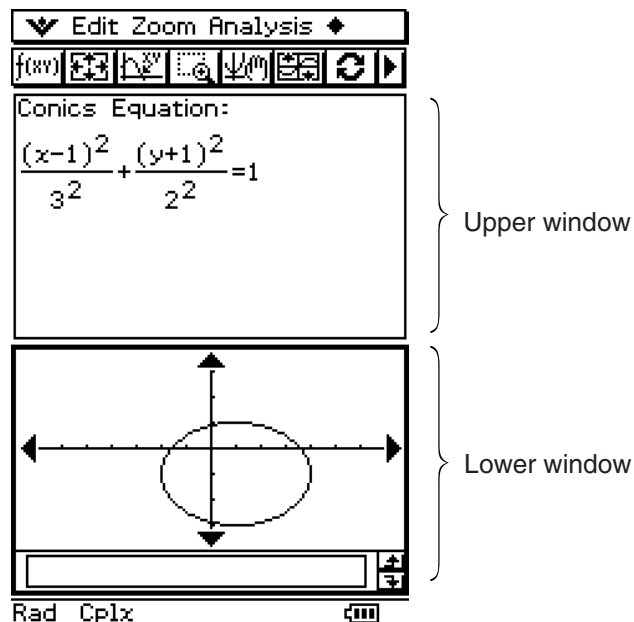



When using two windows, the currently selected window (the one where you can perform operations) is called the “active window”. The menu bar, toolbar, and status bar contents are all applicable to the active window. The active window is indicated by a thick boundary around it.

• To switch the active window



While a dual window is on the display, tap anywhere inside the window that does not have a thick boundary around it to make it the active window.

- Note that you cannot switch the active window while an operation is being performed in the current active window.



• To resize the active window so it fills the display

While a dual window is on the display, tap . This causes the active window to fill the display. To return to the dual window display, tap  again.

• To swap the upper and lower windows

While a dual window is on the display, tap . This causes the upper window to become the lower window, and vice versa. Swapping windows does not have any effect on their active status. If the upper window is active when you tap  for example, the window will remain active after it becomes the lower window.

Tip

- When you tap  button while a dual window is on the display, the currently active window will fill the display, but the other (inactive) window does not close. It remains open, hidden behind the active window. This means you can tap  to bring the hidden window forward and make it the active window, and send the current active window to the background.

• To close the active windows

While a dual window is on the display, tap  at the top right corner of the window to close the active window, which causes the other (inactive) window to fill the display.

Tip

- When the close () button is dimmed, it means that the active window cannot be closed for some reason.



Using the Menu Bar

The menu bar appears along the top of the window of each application. It shows the menus that you can access for the currently active window.



Tapping the menu bar menu displays its commands, options, and settings from which you can choose the one you want. Some menu items have a single selection as shown in Example 1, below, while other menu items display a submenu of selections from which you can choose as shown in Example 2.

Example 1: Choosing the [Edit] menu's [Copy] item

• ClassPad Operation

(1) Tap [Edit].

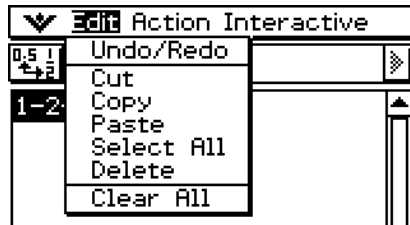

- This displays the contents of the [Edit] menu.

(2) Tap [Copy].

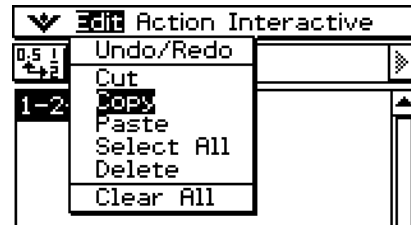

- This performs a copy operation.

Example 2: Choosing [lim], which is on the [Calculation] submenu of the [Action] menu.

• ClassPad Operation

(1) Tap [Action].

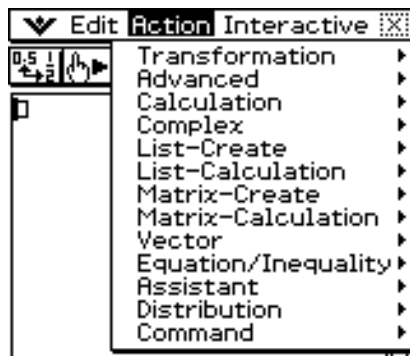

- This displays the contents of the [Action] menu.

(2) Tap [Calculation].

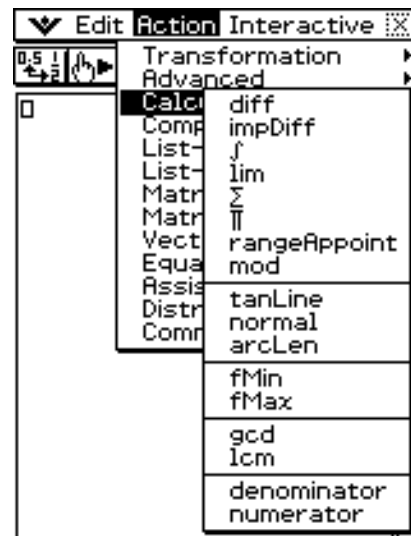

- This displays the contents of the [Calculation] submenu.

(3) Tap [lim].

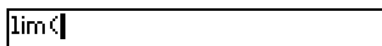

- This inputs "lim(".



Using the Menu

The  menu appears at the top left of the window of each application, except for the System application.

You can access the  menu by tapping  on the icon panel, or by tapping the menu bar's  menu.

Menu Items

The following describes all of the items that appear on the  menu.

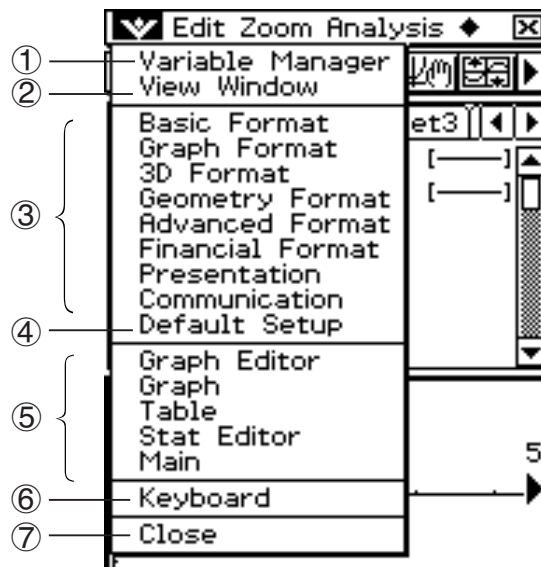

- ① Tapping [Variable Manager] starts up the Variable Manager. See “1-8 Using the Variable Manager” for details.
- ② Tapping [View Window] displays a dialog box for configuring the display range and other graph settings. For details, see the explanations for the various applications with graphing capabilities (Graph & Table, Conics, 3D Graph, Statistics, etc.)
- ③ Tapping a menu selection displays a dialog box for configuring the corresponding setup settings. See “1-9 Configuring Application Format Settings” for details.
- ④ Tapping [Default Setup] returns all settings to their initial defaults (except for the current folder setting). See “1-9 Configuring Application Format Settings” for details.
- ⑤ This area shows a list of all of the windows that can be accessed from the current application (Graph & Table application in this example). Tapping a menu selection displays the corresponding window and makes it active. For details, see “Using the  Menu to Access Windows” on page 1-5-5.
- ⑥ Tap [Keyboard] to toggle display of the soft keyboard on and off.
- ⑦ Tapping [Close] closes the currently active window, except in the following cases.
 - When only one window is on the display
 - When the currently active window cannot be closed by the application being used
 You cannot, for example, close the Graph Editor window from the Graph & Table application.



■ Using the Menu to Access Windows

Most ClassPad applications support simultaneous display of two windows. When two windows are on the display, the one with a thick selection boundary around it is the active window. The displayed menu and toolbar are the ones for the currently active window. You can use the  menu to change the active window and to display the window you want.

● Window Selection Example (Graph & Table)

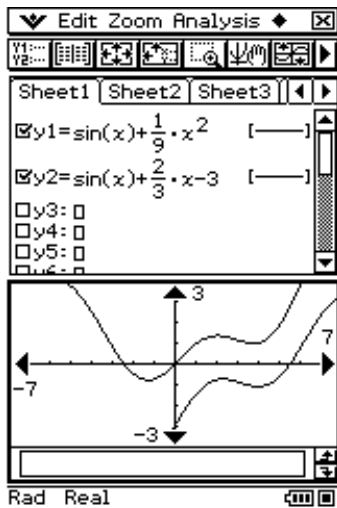

(1) Graph window is active.

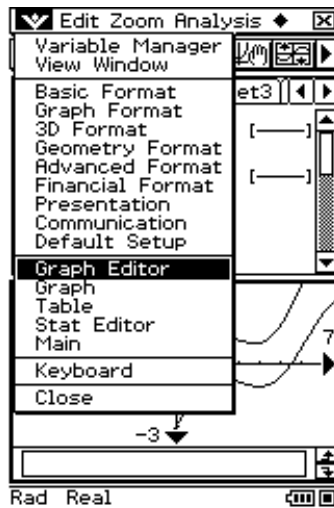

(2) Tap  and then [Graph Editor].

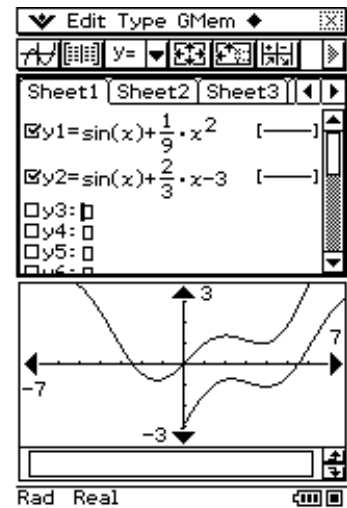

(3) Graph Editor window becomes active.

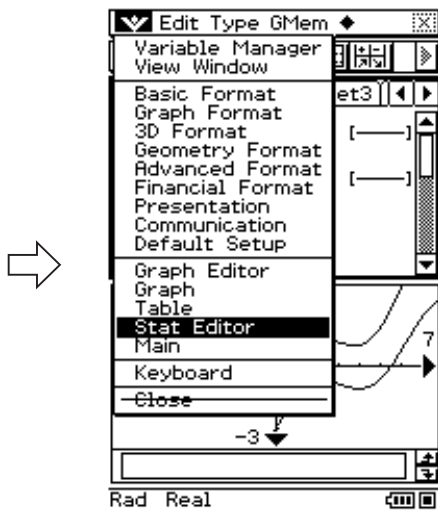

(4) Tap  and then [Stat Editor].

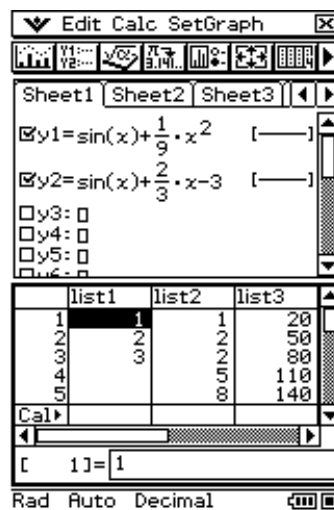

(5) Stat Editor window appears and becomes active.



Using Check Boxes

A check box shows the current status of a dialog box option that can be turned on or off. An option is turned on (selected) when its check box has a check mark inside it. An option is turned off when a check box is cleared.

Tapping a check box toggles the option on (checked) and off (cleared).

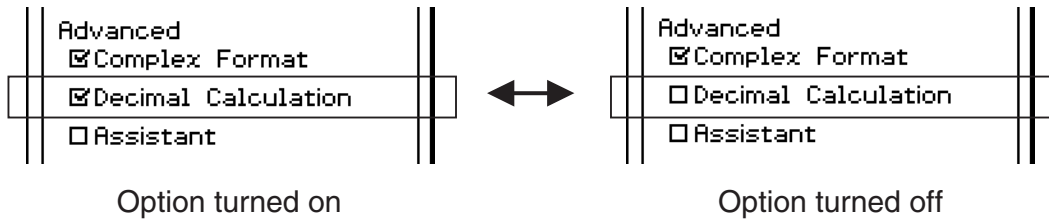

Check boxes also appear on menus. Menu check boxes operate the same way as dialog box check boxes.

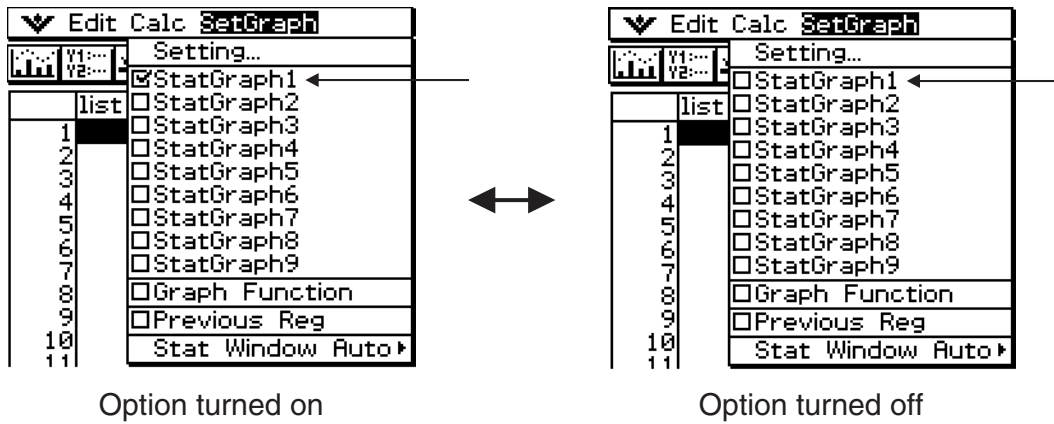



Using Option Buttons

Option buttons are used on dialog boxes that present you with a list of options from which you can select only one. A black option button indicates the currently selected option, while the buttons of the options that are not selected are white.

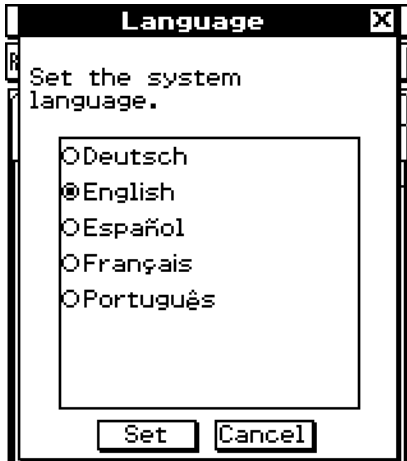

Tap "Français".

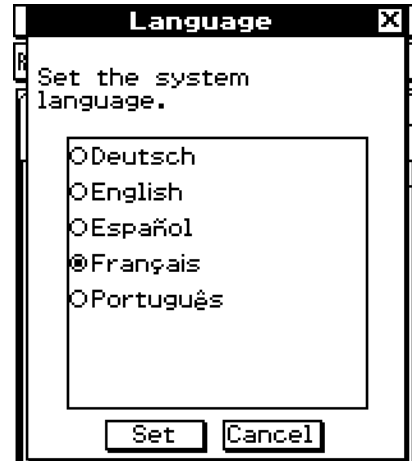

This selects "Français" and deselects "English".

Option buttons also appear on menus. Menu option buttons operate the same way as dialog box option buttons.

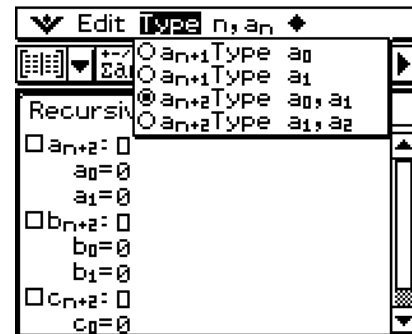
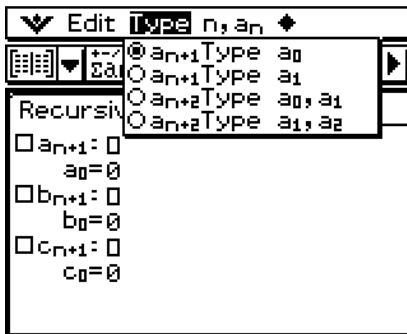



Using the Toolbar

The toolbar is located directly underneath the menu bar of an application window. It contains the buttons for the currently active window.

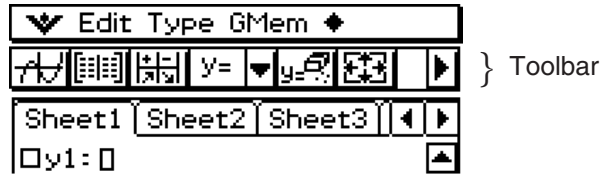

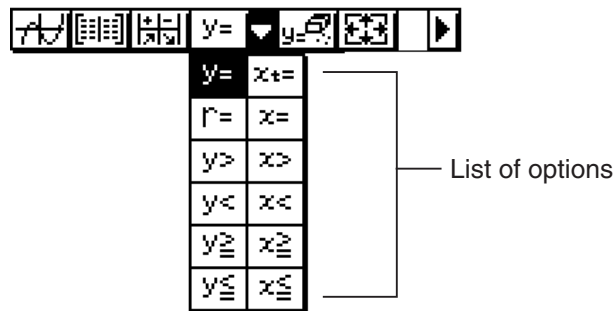

■ Toolbar Buttons

Normally, you tap a button to execute the command assigned to it. Some buttons, however, have a down arrow  next to them. Tapping the arrow displays a list of options from which you can select.



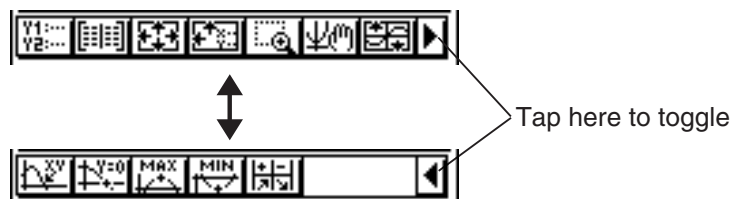

■ Toggling between Multiple Toolbars

With some applications, not all of the buttons can fit on a single toolbar. When this happens, the buttons that cannot fit are placed onto a second toolbar. When there are two toolbars, each of them has an arrow button on the far right. Toolbar 1 has a  button while toolbar 2 has a  button. Tapping an arrow button toggles between the two toolbars.



Tip

- The explanations in this manual make no distinction between toolbar 1 and toolbar 2. Even if a button is located on toolbar 2 (like the  button in the above example) you will be instructed simply to “tap ”.



Interpreting Status Bar Information

The status bar appears along the bottom of the window of each application.

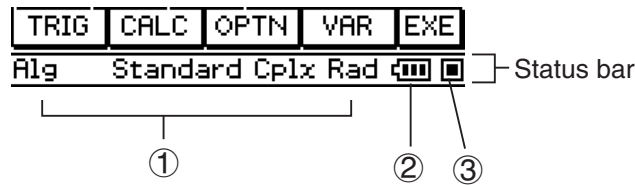





① Information about current application

Tip

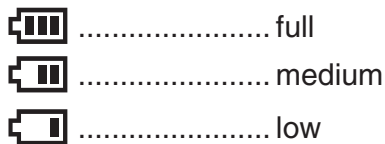

- You can change the configuration of a setting indicated in the status bar by tapping it. Tapping “Cplx” (indicating complex number calculations) while the Main application is running will toggle the setting to “Real” (indicating real number calculations). Tapping again will toggle back to “Cplx”. For information about application-specific information that appears in the status bar, see the sections in this manual that describes each application.

② Battery level indicator



③ This indicator flashes between  and  while an operation is being performed.  appears here to indicate when an operation is paused.

Important!

- Be sure to replace batteries as soon as possible whenever the battery level indicator shows  (medium).
- Replace batteries immediately whenever the battery level indicator shows  (low). At this level, you will not be able to perform data communication or other functions.
- The following message indicates that batteries are about to die. Replace batteries immediately whenever this message appears.



Batteries are extremely low!
Replace batteries immediately!

- See page α -3-2 for details about replacing batteries.

Pausing and Terminating an Operation

Many of the built-in applications provide operations to pause and terminate (break) expression processing, graphing, and other operations.

■ Pausing an Operation

Pressing the  key while an expression processing, graphing, or other operation is being performed pauses the operation. Pressing  again resumes the operation.



Example: To pause a graphing operation and then resume it

• ClassPad Operation

(1) Use the Graph & Table application to draw a graph.

- For details about graphing, see “Chapter 3 – Using the Graph & Table Application”.

(2) While the graph is being drawn, press the  key.

- This pauses the draw operation and displays  on the right side of the status bar.

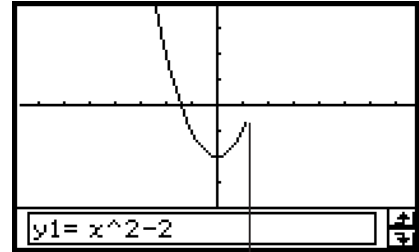

Draw is paused at the point where  is pressed.

(3) To resume the operation, press the  key again.

- This resumes the draw operation, which continues until the graph is complete.

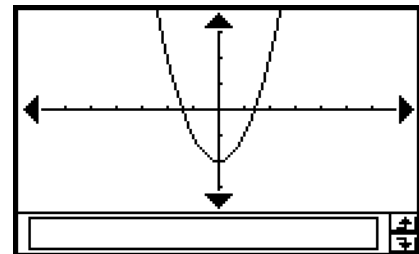

■ Terminating an Operation (Break)

Pressing the  key while an expression processing, graphing, or other operation is being performed terminates the operation.

Example: To terminate a graphing operation

• ClassPad Operation

(1) Use the Graph & Table application to draw a graph.

- For details about graphing, see “Chapter 3 – Using the Graph & Table Application”.

(2) While the graph is being drawn, press the  key.

- This terminates the draw operation and displays the Break dialog box, indicating the Break state.



Break dialog box

(3) To exit the Break state, tap the [OK] button.

- This returns the ClassPad to its status before you started the graphing operation.



1-6 Input

You can input data on the ClassPad using its keypad or by using the on-screen soft keyboard.

Virtually all data input required by your ClassPad can be performed using the soft keyboard. The keypad keys are used for input of frequently used data like numbers, arithmetic operators, etc.

Using the Soft Keyboard

The soft keyboard is displayed in the lower part of the touch screen. A variety of different special-purpose soft keyboard styles help to take much of the work out of data input.

• To display the soft keyboard

When the soft keyboard is not on the touch screen, press the **Keyboard** key, or tap the **☰** menu and then tap [Keyboard]. This causes the soft keyboard to appear.

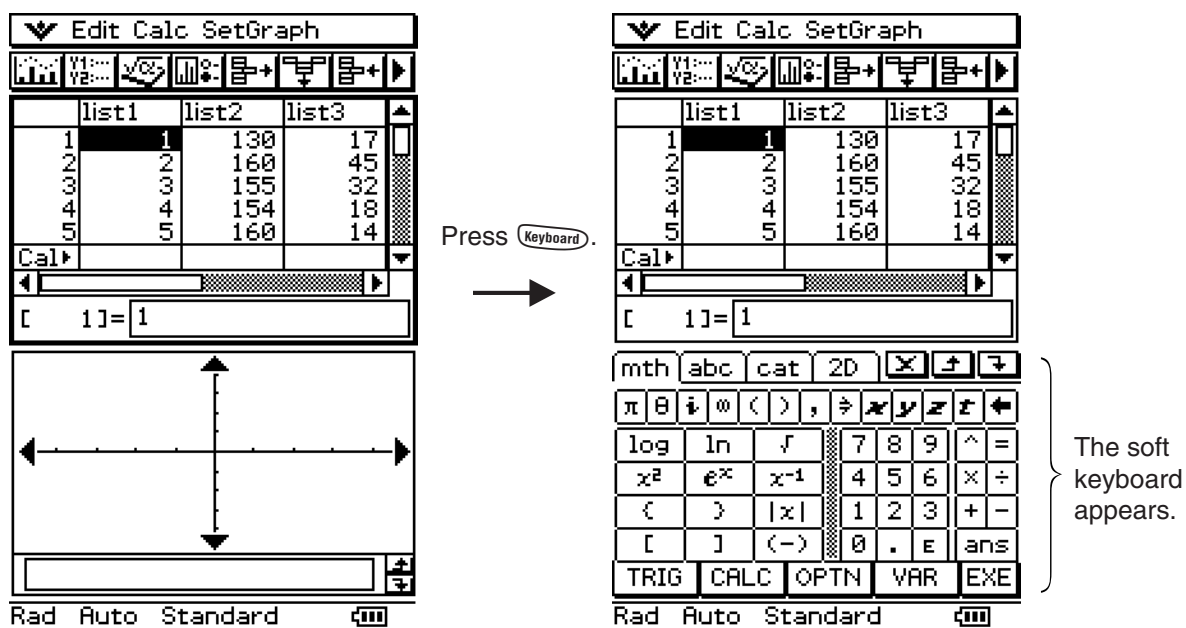

- Pressing the **Keyboard** key again hides the soft keyboard.
- The icon panel's **Resize** icon is disabled while the soft keyboard is on the display. For details about **Resize**, see "Using a Dual Window Display" on page 1-5-1.



■ Soft Keyboard Styles

There are four different soft keyboard styles as described below.

• Math (mth) Keyboard

Pressing **Keyboard** will display the keyboard that you last displayed while working in that application. If you quit the application and go into another application, then the **mth** (default) soft keyboard appears.

You can use the math (mth) keyboard to input values, variables, and expressions. Tap each lower button to see additional characters, for example tap **CALC**. For more information, see “Using the Math (mth) Keyboard” on page 1-6-8.

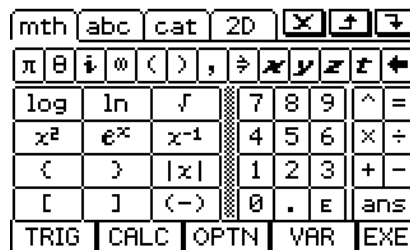

• Alphabet (abc) Keyboard

Use this keyboard to input alphabetic characters, Greek characters, and other characters, as well as logical symbols and other numeric symbols. Tap one of the buttons along the bottom of the keyboard to see additional characters, for example, tap **MATH**. For more information, see “Using the Alphabet (abc) Keyboard” on page 1-6-10.



• Catalog (cat) Keyboard

This keyboard provides a scrollable list that can be used to input built-in functions, built-in commands, system variables, and user-defined functions. Tap a command to select it and then tap it again to insert it. Selecting an item from the Form list changes the available commands. For more information, see “Using the Catalog (cat) Keyboard” on page 1-6-13.



• 2D Keyboard

This keyboard displays various templates for natural input of fractions, exponential values, matrices, differential and integral calculus expressions, etc. Note that natural input is available in most ClassPad applications. Natural input cannot be used in the geometry measurement box or when entering data into a list. For more information, see “Using the 2D Keyboard” on page 1-6-15.

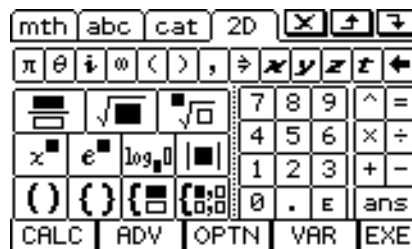

Tip

- 2D math symbols are easy to use. Just tap the image of the symbol you would like to use and it will appear in your application.
- 2D math symbols can be used in most applications.



■ Selecting a Soft Keyboard Style

Tap one of the tabs along the top of the soft keyboard (**mth**, **abc**, **cat**, or **2D**) to select the keyboard style you want.

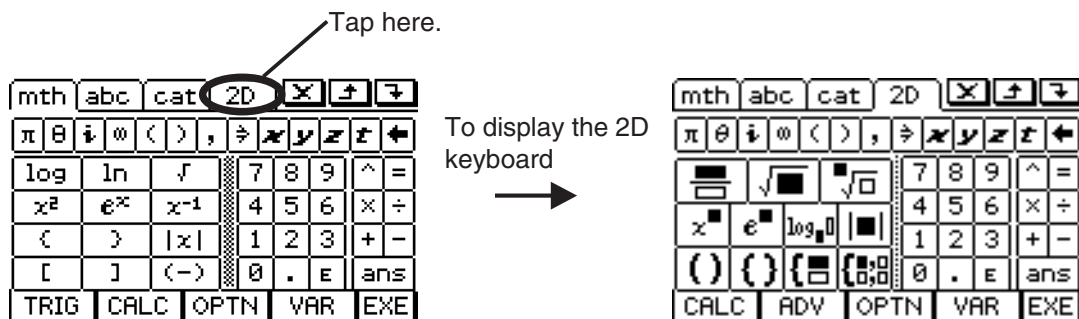

Input Basics

This section includes a number of examples that illustrate how to perform basic input procedures. All of the procedures assume the following.

- The Main application is running.
For details, see “Starting a Built-in Application” on page 1-4-2.
- The soft keyboard is displayed.
For details, see “Using the Soft Keyboard” on page 1-6-1.

■ Inputting a Calculation Expression

You can input a calculation expression just as it is written, and press the **EXE** key to execute it. The ClassPad automatically determines the priority sequence of addition, subtraction, multiplication, division, and parenthetical expressions.

- Before starting any calculation, be sure to clear the ClassPad by pressing **Clear**.
See Chapter 2 for more information about inputting expressions.
- Use the **(-)** or **(-)** key to input the minus sign before a negative value.

Example 1: To simplify $-2 + 3 - 4 + 10$

• ClassPad Operation

Using the keypad keys

Clear **(-)** **2** **+** **3** **-** **4** **+** **1** **0** **EXE**

Using the soft keyboard

Tap the keys of the math (mth) keyboard or the 2D keyboard to input the calculation expression.

Clear **mth** **(-)** **2** **+** **3** **-** **4** **+** **1** **0** **EXE**

-2+3-4+10 **7**

When the soft keyboard is not on the touch screen, press the **Keyboard** key, or tap the menu and then tap [Keyboard]. This causes the soft keyboard to appear on the display.



Example 2: To simplify $2(5 + 4) \div (23 \times 5)$

• ClassPad Operation

Using the keypad keys

Using the soft keyboard

Tap the keys of the math (mth) keyboard or the 2D keyboard to input the calculation expression.

2(5+4)/(23×5)	
	18
	115

Tip

- As shown in Example 1 and Example 2, you can input simple arithmetic calculations using either the keypad keys or the soft keyboard. Input using the soft keyboard is required to input higher level calculation expressions, functions, variables, etc.

■ Editing Input

The following are the different techniques you can use to edit your input.

• To change something right after you input it

When the cursor is located at the end of your input, press to delete the character or operator you want to edit.

Example: To change the expression 369×3 to 369×2

(1)

369×3

(2)

369×

(3)

369×2

Tip

- Or, drag your stylus across 3 to select it and input 2.

**• To delete an unneeded key operation**

Use \leftarrow and \rightarrow to move the cursor to the location immediately to the right of the key operation you want to delete, and then press \leftarrow . Each press of \leftarrow deletes one command to the left of the cursor.

Example: To change the expression $369 \times \times 2$ to 369×2

(1)		
(2)		

Tip

- You can move the cursor without using the cursor key by tapping at the destination with the stylus. This causes the cursor to jump to the location where you tap.

• To correct a calculation expression

Use \leftarrow and \rightarrow to move the cursor to the location immediately to the right of the location you want to correct, and then press \leftarrow .

Example: To correct $\cos(60)$ so it becomes $\sin(60)$

(1) Use the mathematics (mth) keyboard to input “cos(60)”.		
Tapping the TRIG key causes it to change to and displays a key set for inputting trigonometric functions.		
(2) Move the cursor to the location immediately to the right of “cos(”.		
(3) Delete “cos(”.		
(4) Input “sin(”.		
(5) Tap to return to the initial math (mth) key set. See “Using the Math (mth) Keyboard” on page 1-6-8 for details.		

Tip

- Or, drag your stylus across “cos(” to select it and input “sin(”.

After you make all of the changes you want, press EXE to calculate the result. To continue inputting the calculation, press \rightarrow to move the cursor to the end of the calculation, and input what you want.



- **To insert new input into the middle of an existing calculation expression**

Use or to move the cursor to the location where you want to insert new input, and then input what you want.

Example: To change 2.36^2 to $\sin(2.36^2)$

(1)	2.36^2
(2)	2.36^2
(3)	sin(2.36^2

Tip

- You can move the cursor without using the cursor key by tapping at the destination with the stylus. This causes the cursor to jump to the location where you tap.

- **To replace a range of input with new input**

After you drag the stylus across the range of input that you want to replace, enter the new input.

Example: To replace the “234” of “1234567” with “0”.

(1) Input “1234567”. 	1234567
(2) Drag the stylus across “234” to select it.	1234567
(3) Input “0”. 	10567

Tip

- You can perform and key operations by pressing the corresponding keypad key or soft key.



■ Using the Clipboard for Copy and Paste

You can copy (or cut) a function, command, or other input to the ClassPad's clipboard, and then paste the clipboard contents at another location.

● To copy characters

- (1) Drag the stylus across the characters you want to copy to select them.
- (2) On the soft keyboard, tap .
 - This puts a copy of the selected characters onto the clipboard.

$$y=3x^2+5x-8$$

$$y=3x^2+5x-8$$

The selected characters are not changed when you copy them.

Tip

- You can also copy characters by tapping the [Edit] menu and then tap [Copy].

● To cut characters

- (1) Drag the stylus across the characters you want to cut to select them.
- (2) On the soft keyboard, tap .
 - This moves the selected characters onto the clipboard.

$$y=3x^2+5x-8$$

$$y=3x^2-8$$

Cutting causes the original characters to be deleted.

Tip

- Performing a copy or cut operation causes the clipboard contents to be replaced by the newly copied or cut characters.
- You can also cut characters by tapping the [Edit] menu and then tap [Cut].

● To paste the clipboard contents

- (1) Move the cursor to the location where you want to paste the clipboard contents.
- (2) On the soft keyboard, tap .
 - This pastes the clipboard contents at the current cursor location.

$$y=3x^2-8$$

$$y+5x=3x^2-8$$

Tip

- The clipboard contents remain on the clipboard after you paste them. This means you can paste the current contents as many times as you like.
- You can also paste the clipboard contents by tapping the [Edit] menu and then tap [Paste].



• **Copying and pasting in the message box**

The “message box” is a 1-line input and display area under the Graph window (see Chapter 3).

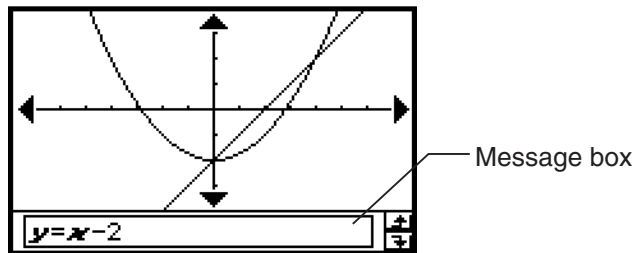

You can use the two buttons to the right of the message box to copy the message box contents (⌘ button), or to paste the clipboard contents to the message box (⇧ button). Copy and paste are performed the same way as the copy and paste operations using the soft keyboard.

Advanced Soft Keyboard Operations

As explained in “Using the Soft Keyboard” on page 1-6-1, there are four soft keyboard types: the math (mth) keyboard, the alphabet (abc) keyboard, the catalog (cat) keyboard, and the 2D math (2D) keyboard. This section provides more detailed information about soft keyboard operations and the various key sets available with each soft keyboard.

- All of the explanations in this section start from the initial key set of each keyboard.

■ Using the Math (mth) Keyboard

The math (mth) keyboard is for inputting calculation expressions and numeric expressions. In addition to the initial math (mth) key set, you can also select from among four other key sets named **TRIG** (trigonometry), **CALC** (calculus), **OPTN** (option), and **VAR** (variable).

• **Initial math (mth) keyboard key set**

If you stay in the same application, the keyboard that you used last will appear when you press the **Keyboard** key.

mth	abc	cat	2D	✕	⬆	⬇
π	θ	i	∞	()	,
log	ln	√		7	8	9
x ²	e ^x	x ⁻¹		4	5	6
()	x		1	2	3
[]	(-)		0	.	E
ans						
TRIG	CALC	OPTN	VAR	EXE		



• **TRIG** key set

Tapping the **TRIG** key displays keys for inputting trigonometric functions, and changes the **TRIG** softkey to . You can tap this key to toggle between **TRIG** and the default **mth** keyboard. Tapping the **hyp** (hyperbolic) key switches to a key set for inputting hyperbolic functions. Tap the **hyp** key again to return to the regular **TRIG** key set.

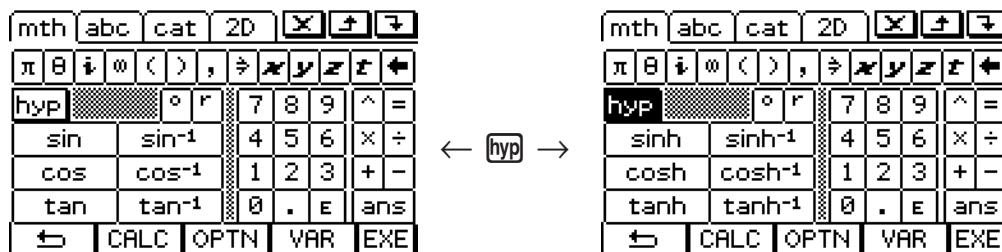

• **CALC** key set

Tapping the **CALC** key displays keys for inputting differential and integral calculus expressions, permutations, etc., and changes the **CALC** softkey to . You can tap this key to toggle between **CALC** and the default **mth** keyboard.

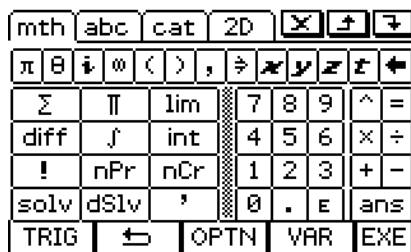

Tip

- Tapping the **solv** key inputs the “solve” function, while tapping the **dSlv** key inputs the “dSolve” function. See pages 2-8-43 and 2-8-44 for information about these functions.
- For information about each of functions or symbols, see “2-4 Function Calculations”.

• **OPTN** key set

Tapping the **OPTN** key displays keys for inputting “<”, “≠”, and other special operators, and changes the **OPTN** softkey to . You can tap this key to toggle between **OPTN** and the default **mth** keyboard.

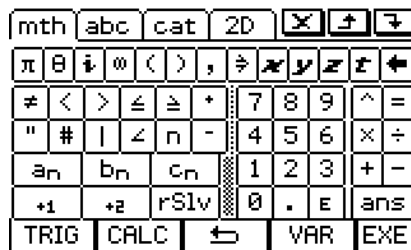

Tip

- Tapping the **rSlv** key inputs the “rSolve” function. See page 6-3-5 for information about this function.
- For information about each of the functions and symbols, see “2-4 Function Calculations”.



• **VAR** key set

Tapping the **VAR** key displays keys for inputting single-character variables, and changes the **VAR** softkey to **↔**. You can tap this key to toggle between **VAR** and the default **math** keyboard. Tapping the **CAP** key switches to a key set for inputting upper-case single-character variables.

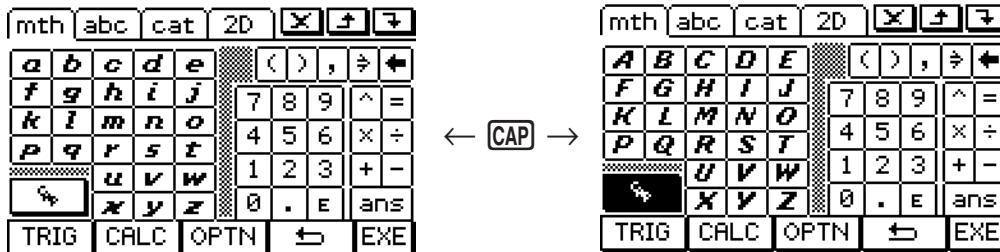

Tip

- As its name suggests, a single-character variable is a variable name that consists of a single character like “a” or “x”. Each character you input on the **VAR** keyboard is treated as a single-character variable. To input multiple-character variable names like “ab” or multiple-character strings, you must use the alphabet (abc) keyboard. For more information, see “Using Single-character Variables” on page 1-6-12.
- For information about the **ans** key that appears in the lower right of all of the math (mth) keyboard key sets, see “Using the Answer Variable (ans)” on page 2-2-2.

■ **Using the Alphabet (abc) Keyboard**

In addition of the initial alphabet (abc) key set, you can also select from among three other key sets, within alphabet (abc), named **αβγ** (character symbols), **MATH** (mathematics symbols), and **SMBL** (extra symbols).

• **Initial alphabet (abc) keyboard key set**

This keyboard is for inputting lower-case alphabetic characters. Tap **↑** to shift the keyboard or **CAP** to caps lock the keyboard when you want to input upper-case characters.

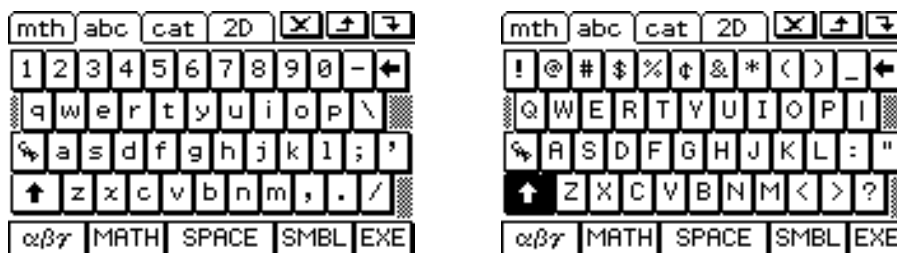

- Note that the initial alphabet (abc) keyboard uses the qwerty key arrangement, which is similar to a computer keyboard. You can also change to an azerty or qwertz arrangement. See “16-9 Specifying the Alphabetic Keyboard Arrangement”.



- **$\alpha\beta\gamma$ key set**

Use the $\alpha\beta\gamma$ key set to input Greek characters, Cyrillic characters, and accented characters. Tap the \uparrow and \downarrow buttons to scroll to additional keys. Tapping **CAP** caps locks the keyboard for input of upper-case characters.

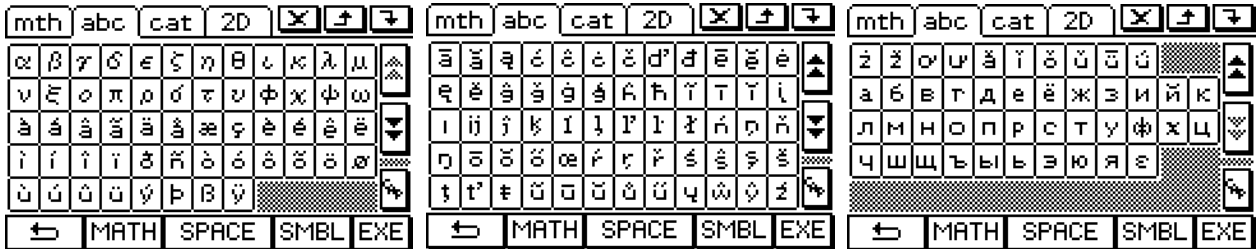

- Tap \leftarrow to return to the initial alphabet (abc) key set.

- **MATH key set**

This key set contains some of the mathematical expression symbols that are also available on the math (mth) keyboard. Tap the \uparrow and \downarrow buttons to scroll to additional keys.



- Tap \leftarrow to return to the initial alphabet (abc) key set.

- **SMBL key set**

Use this key set to input punctuation and symbols. Tap the \uparrow and \downarrow buttons to scroll to additional keys.

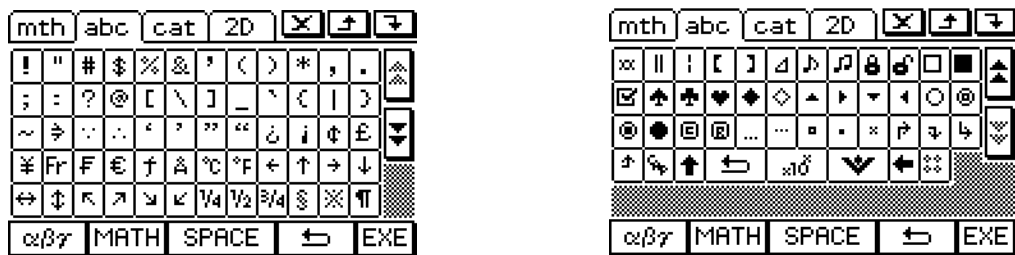

- Tap \leftarrow to return to the initial alphabet (abc) key set.



■ Using Single-character Variables

As its name suggests, a single-character variable is a variable name that consists of a single character like “ a ” or “ x ”. Input of single-character variable names is subject to different rules than input of a series of multiple characters (like “ abc ”).

● To input a single-character variable name

Any character you input using any one of the following techniques is always treated as a single-character variable.

- Tapping any key in the math (mth) keyboard’s **VAR** key set (page 1-6-10)
- Tapping any key in the 2D keyboard’s **VAR** key set (page 1-6-17)
- Tapping the **x**, **y**, **z** or **t** key to the left of the **←** key of the math (mth) keyboard or 2D keyboard
- Pressing the **(x)**, **(y)**, or **(z)** keypad key

If you use the above key operations to input a series of characters, each one is treated as a single-character variable. Inputting **a**, **b**, **c**, for example, is treated as the mathematical expression $a \times b \times c$, and not as the characters “ abc ”.

Tip

- The single-character variables described above make it possible for you to perform calculations as they appear in your textbook.

Example 1: **mth** **VAR** **a** **b** **c** **EXE**

<i>abc</i>	$a \cdot b \cdot c$
-------------------	---------------------

Example 2: **(2)** **(x)** **(y)** **EXE**

<i>2xy</i>	$2 \cdot x \cdot y$
-------------------	---------------------

Tip

- When you input a single-character variable, its name appears on the display as an italicized bold character. This is simply to let you know that the letter is a single-character variable name.

**• To input a series of multiple characters**

A series of multiple characters (like “list1”) can be used for variable names, program commands, comment text, etc. Always use the alphabet (abc) keyboard when you want to input a series of characters.

Example:

You can also use the alphabet (abc) keyboard to input single-character variable names. To do so, simply input a single character, or follow a single character with a mathematical operator.

Example:

Tip

- A single-character variable you input using the alphabet (abc) keyboard is identical to a single-character variable you input using the math (mth) keyboard.

■ Using the Catalog (cat) Keyboard

The “Form” menu of the catalog keyboard lets you select one of the following five categories: [Func] (built-in functions on pages 2-4-2 and 2-8-1), [Cmd] (built-in commands and operators on pages 1-7-4 and 12-6-1), [Sys] (system variables on page α-7-1), [User] (user-defined functions on page 12-5-1), and [All] (all commands, functions, etc.). After selecting a category, you can choose the item you want from the alphabetized list that appears on the catalog (cat) keyboard.

Tip

- Note that user-defined variables and user-defined programs cannot be input using the catalog (cat) keyboard. Use the Variable Manager (page 1-8-1) instead.
- A user-defined function must be stored in the “library” folder to appear in the catalog (cat) keyboard list when the [User] category is selected.



• **Catalog (cat) keyboard configuration**

This is an alphabetized list of commands, functions, and other items available in the category currently selected with “Form”.

Tap the down button and then select the category you want ([Func], [Cmd], [Sys], [User], or [All]) from the list that appears.

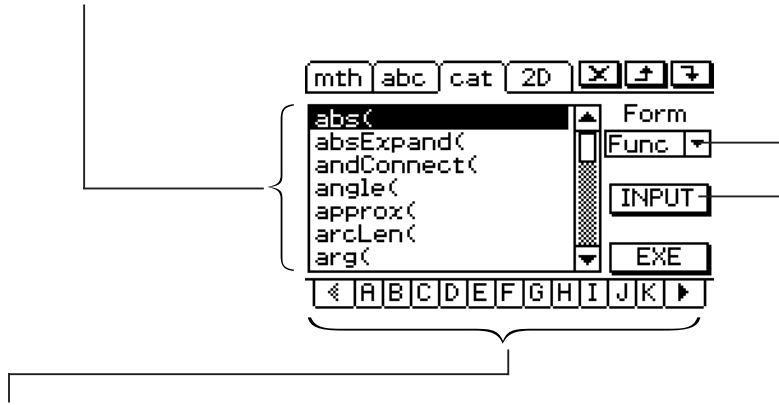

Tapping a letter button displays the commands, functions, or other items that begin with that letter.

Tap this key to input the item that is currently selected in the alphabetized list.

• **To use the catalog (cat) keyboard**

Example: To input the built-in “Plot” command

- (1) Tap **[cat]** to display the catalog (cat) keyboard.
- (2) Tap the “Form” down arrow button and then select [Cmd] from the list of categories that appears.
- (3) Tap the button in the lower right corner until the **[P]** key is visible.

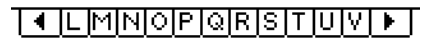

- (4) Tap **[P]**.

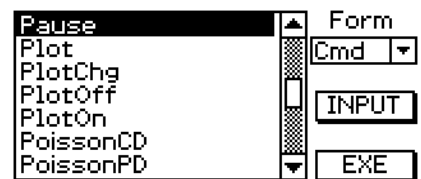

- (5) In the alphabetized list, tap “Plot”.

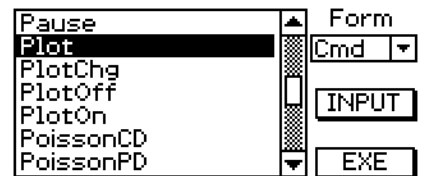

- (6) Tap [INPUT] to input the command.

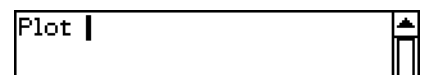

Tip

- Instead of tapping [INPUT] in step (6), you could also tap the command you selected in step (5) a second time to input the command.



■ Using the 2D Keyboard

The 2D keyboard provides you with a number of templates that let you input fractions, exponential values, n th roots, matrices, differentials, integrals, and other complex expressions as they appear in your textbook.

It also includes a **VAR** key set that you can use to input single-character variables like the ones you can input with the math (mth) keyboard.

• Initial 2D keyboard key set

This key set lets you input fractions, exponential values, n th roots, etc. as they appear in your textbook.

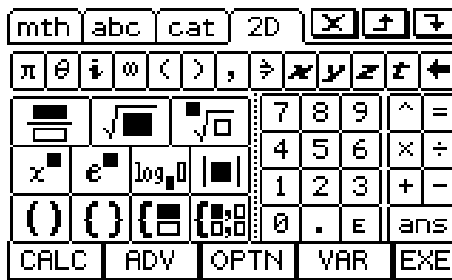

Tip

- For information about each function or symbol, see “2-4 Function Calculations”.
- Use the key to input the piecewise function template. See page 2-4-12 for more information.
- Use the key to input the simultaneous equations template. See page 2-8-43 for more information.

• **CALC** key set

Tapping the **CALC** key displays a keyboard like the one shown below, which has a key in place of the **CALC** key. Tapping returns to the initial 2D keyboard.

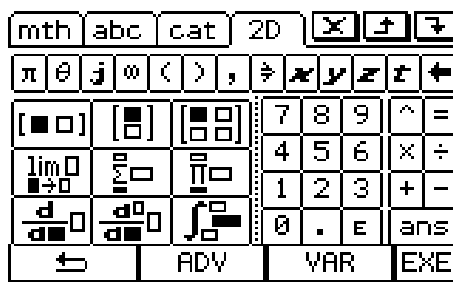

The following are the mathematical expressions you can input with this 2D keyboard.

To input this:	Use these keys:	For more information, see:
Matrix templates	, ,	“Matrix and Vector Calculations” on page 2-6-1.
Limit template		“lim” under “Using the Calculation Submenu” on page 2-8-15.
Sum template		“ Σ ” under “Using the Calculation Submenu” on page 2-8-15.



To input this:	Use these keys:	For more information, see:
Sum of product template		" Π " under "Using the Calculation Submenu" on page 2-8-15.
Differential coefficient template		"diff" under "Using the Calculation Submenu" on page 2-8-13.
Integration template		" \int " under "Using the Calculation Submenu" on page 2-8-14.

• **ADV key set**

Tapping the **ADV** key displays a keyboard like the one shown below, which has a key in place of the **ADV** key. Tapping returns to the initial 2D keyboard.

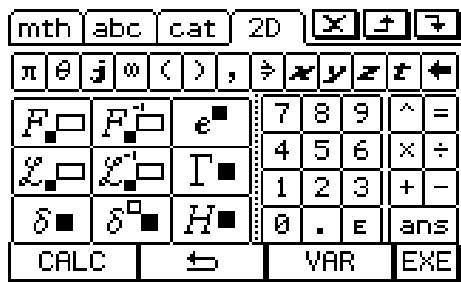

The following are the mathematical expressions you can input with this 2D keyboard.

To input this:	Use these keys:	For more information, see:
Fourier transform template		"fourier" under "Using the Advanced Submenu" on page 2-8-9.
Inverse Fourier transform template		"invFourier" under "Using the Advanced Submenu" on page 2-8-9.
Laplace transform template		"laplace" under "Using the Advanced Submenu" on page 2-8-8.
Inverse Laplace transform template		"invLaplace" under "Using the Advanced Submenu" on page 2-8-8.
Gamma function		"Gamma Function" on page 2-4-18.
Delta function		"Dirac Delta Function" on page 2-4-16.
n^{th} -delta function		" n^{th} Delta Function" on page 2-4-16.
Heaviside function		"Heaviside Unit Step Function" on page 2-4-17.



• **VAR** key set

Tapping the **VAR** key displays keys for inputting single-character variables, and changes the **VAR** softkey to **←**. You can tap this key to toggle between **VAR** and the initial 2D keyboard. Tapping the **CAP** key switches to a key set for inputting upper-case single-character variables.

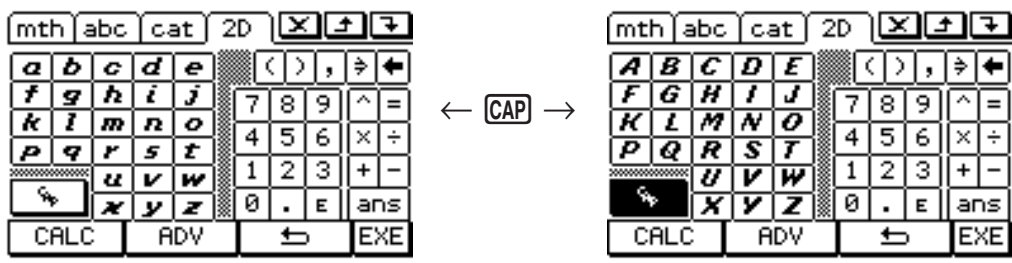

Tip

- As its name suggests, a single-character variable is a variable name that consists of a single character like “a” or “x”. Each character you input on the **VAR** keyboard is treated as a single-character variable. You cannot use the **VAR** keyboard to input multiple-character variable names like “ab” or multiple-character strings. You must use the alphabet (abc) keyboard when you want to input a multiple-character string. For more information, see “Using Single-character Variables” on page 1-6-12.
- For information about the **ans** key that appears in the lower right of all of the 2D keyboard key sets, see “Using the Answer Variable (ans)” on page 2-2-2.
- Note that natural input is available in most applications of the ClassPad. Natural input cannot be used in the geometry measurement box or when entering data into a list.

• **To use the 2D keyboard for natural input**

Example 1: To input $\frac{1}{5} + \frac{3}{7}$

- (1) On the application menu, tap to start the Main application.
- (2) Press the **Clear** key.
- (3) Press the **Keyboard** key, and then tap **2D** to display the 2D keyboard.

(4) Tap and then tap **1** to input the numerator.

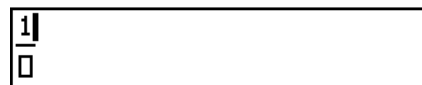

(5) Tap the input box of the denominator to move the cursor there, or press and then tap **5**.

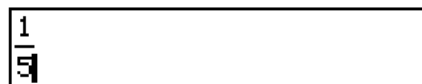

(6) Press to move the cursor to the right side of 1/5.
• Instead of using to move the cursor, you could also tap with the stylus at the cursor destination.

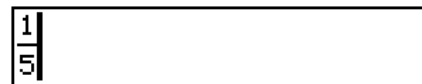

(7) Tap **+**.

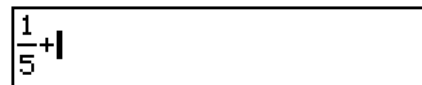

(8) Tap , and then repeat steps (4) through (6) to input 3/7.



(9) After everything is the way you want, press **EXE**.



Tip

- If you want your ClassPad to evaluate a calculation expression and display a result in the eActivity application, you must input the calculation in a calculation row. See “Inserting a Calculation Row” on page 10-3-3.

Example 2: To input $\sum_{k=1}^n k^2$

(1) Tap **2D** to display the 2D keyboard and then tap **CALC**.

(2) Tap

Initially, the cursor appears here.

(3) In the input box below Σ , input “k=1”.

VAR **k** **▶** **1**

(4) Tap with the stylus to move the cursor to the other input locations and input the required information.

In the input box above Σ , tap **n**.

(5) Input the part of the expression that comes to the right of Σ .

k **←** **↑** **xⁿ** **2**

(6) After everything is the way you want, press **EXE**.

Example 3: To input $\int_0^1 (1-x^2) e^x dx$

(1) Tap **2D** to display the 2D keyboard and then tap **CALC**.

(2) Tap

Initially, the cursor appears in the input box to the right of \int .

(3) Input the part of the expression that comes to the right of \int .

(**1** **-** **x** **↑** **xⁿ** **2** **▶** **)**
e^x **x** **▶** **x**

- Or you can use 2D math symbols to enter the expression.



- (4) Tap with the stylus to move the cursor to the other input locations to enter the limits of integration.

In the input box above \int , tap $\boxed{1}$.

In the input box below \int , tap $\boxed{0}$.

$$\int_0^1 (1-x^2)e^x dx$$

- (5) After everything is the way you want, press $\textcircled{\text{EXE}}$.



1-7 Variables and Folders

Your ClassPad lets you register text strings as *variables*. You can then use a variable to store a value, expression, string, list, matrix, etc. A variable can be recalled by a calculation to access its contents.

Variables are stored in folders. In addition to the default folders that are provided automatically, you can also create your own user folders. You can create user folders as required to group variables by type or any other criteria.

Folder Types

Your ClassPad stores variables in one of four types of folders described below.

Folder Type	Description
“system” Folder	This is one of the ClassPad’s reserved folders, which is provided by default. It is used for storage of <i>system variables</i> , which are pre-defined variables used by ClassPad applications and other system operations. Some examples of system variables are “list1” through “list6”, View Window parameters “xmin” and “xmax”, etc. A system variable can be accessed by any application simply by specifying the applicable variable name.
“library” Folder	Also a ClassPad reserved folder, the “library” folder can be used for storing user-created variables. Variables stored in the “library” folder can be accessed without specifying a path, regardless of the current folder setting (see next page).
“main” Folder	The “main” folder is also a ClassPad reserved folder, and acts as the default current folder. While the “main” folder is the current folder, all variables created by ClassPad application operations are stored here when you do not specify a path for variable storage.
User Folder	This is a folder created and named by you. You can make a user folder the current folder, move variables to a user folder, etc. You can also delete and rename a user folder as required. You can have up to 87 user folders in ClassPad memory at one time.

Tip

- You cannot put a folder inside of another folder.
- You can view the contents of a folder using the Variable Manager (page 1-8-1). Note, however, that you cannot open the “system” folder for viewing.
- The “system” folder contents are listed within the **cat** page of the keyboard when “Sys” is selected for “Form”.



■ Current Folder

The *current folder* is the folder where the variables created by applications (excluding eActivity) are stored and from which such variables can be accessed. The initial default current folder is the “main” folder.

You can also select a user folder you created as the current folder. For more information about how to do this, see “Specifying the Current Folder” on page 1-8-3.

Variable Types

ClassPad variables can be broadly grouped into three types: general variables, system variables, and local variables.

Variable Type	Description
General Variables	A <i>general variable</i> is one you create using any name you want. Unless you specify otherwise when you are creating it, a general variable is stored in the current folder. You can use the same name for multiple variables, as long as each of them is stored in a different folder. General variables can be deleted, renamed, etc.
System Variables	System variables are pre-defined reserved variables used by ClassPad applications and other system operations. They are stored in the “system” folder. System variables can be accessed without specifying the folder name, and can even be accessed from another folder. Since system variable names are reserved words, they cannot be renamed. Whether you are allowed to delete or change the contents of a system variable depends on each variable. <ul style="list-style-type: none"> • For the names of and detailed information about system variables, see the “System Variable Table” on page α-7-1.
Local Variables	A local variable is a variable that is temporarily created by a defining function, program, or other operation for a particular purpose. A local variable is deleted automatically when execution of the program or user-defined function that created it is complete. You can create a local variable by including the “Local” command in a program. Any variable specified as the argument of a program or a user-defined function is automatically treated as a local variable.



■ Variable Data Types

ClassPad variables support a number of *data types*. The type of data assigned to a variable is indicated by a *data type name*. Data type names are shown on the Variable Manager variable list, and on the Select Data dialog box that appears when you are specifying a variable in any ClassPad application. The following table lists all of the variable data type names and explains the meaning of each.

Data Type Name	Data Type
EXPR	Real number, complex number or expression data
STR	String data
LIST	List data created using the Statistics application, Main application, etc.
MAT	Matrix data created using the Main application, etc.
PRGM*	General program
EXE*	Edit prohibited program
TEXT*	Text data
FUNC*	User-defined function
PICT*	Image data <ul style="list-style-type: none"> • ClassPad image data includes graph image data saved using the Store function, image data captured using the Presentation application, and picture data transferred from the FA-CP1.
GMEM*	Graph memory data saved using the Graph & Table application <ul style="list-style-type: none"> • For more information, see “Saving Graph Editor Data to Graph Memory” on page 3-3-14.
GEO*	Geometry application data
MEM*	General-purpose data
OTHR	Data other than that described above

* Protected variable types

Some data types are *protected*. A variable whose data type is protected cannot be overwritten with another variable, which protects variable contents from being inadvertently altered. Data types whose names are marked with an asterisk in the above table are protected.

Tip

- Note that whether or not a data type is protected is determined by the system. You cannot change the protection status of a data type.
- Even when a variable is a protected data type, you can rename, delete, or move it. To disable these operations, you need to lock the variable. For more information, see “Locking a Variable or Folder” on page 1-7-10.
- The elements of the LIST data type can contain EXPR or STR type data only. The elements of the MAT data type can contain EXPR type data only.



Creating a Folder

You can have up to 87 user folders in memory at the same time. This section explains how to create a user folder and explains the rules that cover folder names.

You can create a folder using either the Variable Manager or the “NewFolder” command.

■ Creating a folder using the Variable Manager



On the Variable Manager window, tap [Edit] and then [Create Folder]. For more information, see “1-8 Using the Variable Manager”.

■ Creating a folder using the “NewFolder” command

In the Main application or in a program, execute the “NewFolder” command.

Example: To create a new folder named “Test”

● ClassPad Operation

- (1) Tap  to display the application menu, and then tap  to start the Main application.
- (2) Display the catalog (cat) keyboard, and then input the “NewFolder” command.
 - a. In the [Form] menu, select [Cmd].
 - b. Tap  and the [N] to display the first command that starts with the letter “N”.
 - c. In the command list, tap “NewFolder” to select it.
 - d. Tap [INPUT].

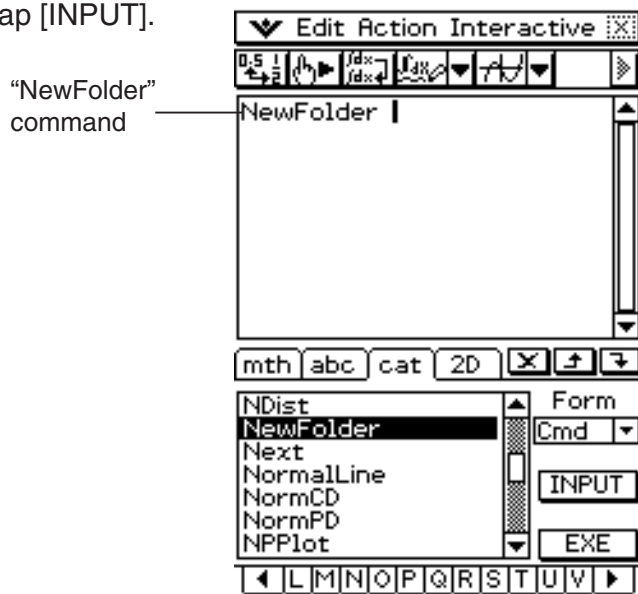

- (3) Following the “NewFolder” command you just input, enter “Test”.



(4) Tap **EXE** to execute the command.

- The message “done” appears on the display to let you know that command execution is complete.

```
NewFolder Test
done
```

Tip

- You can use the Variable Manager to view the contents of a folder you create. For more information, see “1-8 Using the Variable Manager”.
- For information about commands you can use to perform folder operations, see “12-6 Program Command Reference”.

■ Folder Name Rules

The following are the rules that apply to folder names.

- Folder names can be up to 8 bytes long.
- The following characters are allowed in a folder name.
 - Upper-case and lower-case unaccented characters (character codes 65 to 90, 97 to 122)
 - Upper-case and lower-case accented characters (character codes 257 to 416, 513 to 672)
 - Subscript characters (character codes 480 to 491, 496 to 512, 737 to 746, 752 to 766)
 - Numbers (character codes 48 to 57)
 - Underscore (character code 95)
- Folder names are case-sensitive.

For example, each of the following is treated as a different folder name: abc, Abc, aBc, ABC.
- A reserved word (system variable names, built-in function names, command names, etc.) cannot be used as a folder name.
- A number, subscript characters or the underscore (_) cannot be used as the first character of a folder name.

Creating and Using Variables

This section explains how to create a new variable (general variable), and provides a simple sample calculation that illustrates how to use a variable.

■ Variable Name Rules

The rules for naming variables are identical to those that cover folder names. For more information, see “Folder Name Rules” above.



Single-character Variable Precautions

Your ClassPad supports the use of *single-character variables*, which are variables whose names consist of a single character like “a” or “x”. Some ClassPad keys (x, y, z keypad keys, math (mth) soft keyboard [x], [y], [z], [t] keys, [VAR] key set keys, etc.) are dedicated single-character variable name input keys. You cannot use such a key to input a variable name that has more than one character.

For example, pressing the keypad keys (x) and (y) in succession is interpreted by the ClassPad as the multiplication expression “x × y”, and not as the characters “xy”. In order to input a variable name made up of two or more characters, use the alphabet (abc) keyboard. For more information, see “Using Single-character Variables” on page 1-6-12.

Creating a New Variable

The most common way to create a new variable is assigning a value or expression to the applicable variable name. Use the variable assignment key (⇒) to assign data to a variable.





Assign key
This key is included on the math (mth) and 2D soft keyboards.

The following is an example of assignment to a variable while “main” is specified as the current folder.

Example: To create a new variable named “eq1” and assign the expression $2x + 1$ to it
The following assumes that there are no variables named “eq1” or “x” currently in the “main” folder.

ClassPad Operation

- (1) On the application menu, tap  to start the Main application.
- (2) Press  to display the soft keyboard, and then perform the following key operation.

- This creates a variable named “eq1” in the current folder (the “main” folder in this example), and assigns the expression $2x + 1$ to it.

2x+1⇒eq1	2·x+1
----------	-------



Tip

- As shown in the above example, assigning something to a variable with a name that does not yet exist in the current folder causes a new variable with that name to be created. If a variable with the specified name already exists in the current folder, the contents of the existing variable are replaced with the newly assigned data, unless the existing variable is protected. For more information about protected variables, see “Protected variable types” on page 1-7-3.
- To store the newly created variable in a folder other than the current folder, specify the variable name as follows: <folder name>\<variable name>.
- You can use the Variable Manager to view the contents of a variable you create. For more information, see “1-8 Using the Variable Manager”.

Variable Usage Example

The following example uses the variable we created in the example under “Creating a New Variable” on page 1-7-6.

Example: To copy the variable “eq1” and then paste it into the following two equations:
 $eq1 + x - 2$ and $eq1 \times 2$

ClassPad Operation

(1) First, check the current contents of variable “eq1”.

abc **e** **Q** **1** **EXE**

eq1	$2 \cdot x + 1$
-----	-----------------

(2) Copy the variable by dragging the stylus across “eq1” and then tapping , or tap [Edit] [Copy].

eq1	$2 \cdot x + 1$
-----	-----------------

- Copy and paste comes in handy when you need to input the same variable into multiple expressions. You can also drag “eq1” to another line.

(3) Perform the key operation below to input and execute the first expression:

$eq1 + x - 2$.

 (or [Edit] [Paste]) **mth** **+** **x** **-** **2** **EXE**

$eq1 + x - 2$	$3 \cdot x - 1$
---------------	-----------------

(4) Perform the key operation below to replace the current contents of “eq1” with the list {1, 2, 3}.

mth **{** **1** **,** **2** **,** **3** **}** **⇒**  **EXE**

{1, 2, 3} → eq1	{1, 2, 3}
-----------------	-----------

(5) Perform the key operation below to input and execute the second expression:

$eq1 \times 2$

 **mth** **×** **2** **EXE**

$eq1 \times 2$	{2, 4, 6}
----------------	-----------



■ “library” Folder Variables

Variables in the “library” folder can be accessed without specifying a path name, regardless of the current folder.

Example: To create and access two variables, one located in the “library” folder and one located in another folder

● ClassPad Operation

- (1) With “main” specified as the current folder (the default), perform the following operation to create a variable named “eq1” and assign the indicated list data to it.

{1, 2, 3} ⇒ eq1 EXE

- (2) Keeping “main” specified as the current folder, perform the following operation to create a variable named “eq2” in the “library” folder, and assign the indicated list data to it.

{4, 5, 6} ⇒ library \ eq2 EXE

Specifies the “library” folder.

- (3) Check the contents of the two variables.

eq1 EXE

```
eq1
(1,2,3)
```

eq2 EXE

```
eq2
(4,5,6)
```

Since variable “eq2” is stored in the “library” folder, you do not need to indicate a path to access it.

- (4) Change the current folder specification to “Test”.

- Use the Basic Format dialog box (page 1-9-4) or the Variable Manager (page 1-8-1) to change the current folder specification.

- (5) Perform the following operations to view the contents of variables “eq1” and “eq2”.

eq1 EXE

```
eq1
eq1
```

Since this key operation does not access the “main” folder, the variable name (“eq1”) is displayed without showing the variable contents.

main\eq1 EXE

```
main\eq1
(1,2,3)
```

Specifying the path to the “main” folder where “eq1” is located displays the contents of the variable.



eq2 [EXE]

eq2 (4,5,6)

Since variable “eq2” is stored in the “library” folder, you do not need to indicate a path to access it.

Tip

- Specifying a variable name that exists in both the current folder and the “library” folder causes the variable in the current folder to be accessed. For details about the variable access priority sequence and how to access variables in particular folders, see “Rules Governing Variable Access” on page 1-7-11.
- You can use the Variable Manager (page 1-8-1) to move existing variables from the “main” folder or a user folder to the “library” folder, or from the “library” folder to other folders.

Using Stat Editor to Create a LIST Variable

Stat Editor makes creation of LIST variables (variables that contain list data) quick and easy. This capability really comes in handy when you need to perform a calculation (statistical calculations, etc.) that involves a large number of LIST variables.

Stat Editor appears as the initial screen when you start up the Statistics application. You can also access the Stat Editor window from the Main, Graph & Table, and eActivity applications.

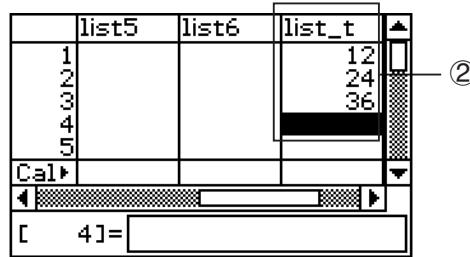
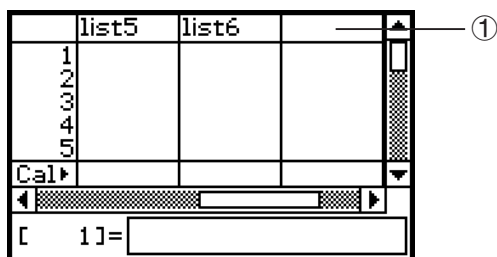

Input a variable name like “list_t” into the title cell at the top of the list on the Stat Editor window (①), and then input values into the list (②). This creates a LIST variable with the name list_t that is assigned the contents of the list of data (②). The above example creates a LIST variable named “list_t” and assigns it the list data “{12, 24, 36}”.

Tip

- For details about using Stat Editor, see “7-2 Using Stat Editor”.



Assigning Values and Other Data to a System Variable

As its name suggests, a *system variable* is a variable that is created and used by the system (page 1-7-5). Some system variables allow you to assign values and other data to them, while some system variables do not. For more information about which variables allow you to control their contents, see the “System Variable Table” on page α-7-1.

Locking a Variable or Folder

Locking a variable or folder protects against inadvertently deleting it or changing its contents. You can unlock a locked variable or folder to re-enable deletion and data assignment.

- Locking a variable disables the following operations on it: delete, overwrite, rename, and move (to another folder).
- Locking a folder makes it impossible to delete or rename the folder.

Tip

- In terms of ClassPad variables, “lock” is completely different from “protect”. For more information about “protect”, see “Variable Data Types” on page 1-7-3.

You can lock and unlock a variable or folder using either the Variable Manager or commands.

• To lock or unlock a variable or folder using the Variable Manager

In the Variable Manager, select the folder or variable you want to lock or unlock and then tap [Edit] - [Lock] or [Edit] - [Unlock]. For more information, see “1-8 Using the Variable Manager”.

• To lock or unlock a variable or folder using commands

In the Main application or in a program, execute one of the commands described below.

To do this:	Use this command syntax:
Lock a variable	Lock <variable name>
Unlock a variable	Unlock <variable name>
Lock a folder	LockFolder <folder name>
Unlock a folder	UnlockFolder <folder name>

For information about commands, see “12-6 Program Command Reference”.



Rules Governing Variable Access

Normally, you access a variable by specifying its variable name. The rules in this section apply when you need to reference a variable that is not located in the current folder or to access a variable that has the same name as one or more variables located in other folders.

■ Variable Search Priority Sequence

Specifying a variable name to access a variable, searches variables in the following sequence.

(1) Local Variables

(2) Current Folder Variables

(3) “library” Folder Variables

- Multiple variables with the same name can exist simultaneously as a local variable, as a variable in the current folder, and as a variable in the “library” folder. In this case, the ClassPad searches folders according to the sequence shown above and accesses the first instance of the variable that it finds. If you want to access such a variable when it occurs lower in the above priority sequence, you need to specify the folder name along with the variable name as shown in “Specifying a Variable in a Particular Folder” below.
- If a variable you specify cannot be found, it is treated as an “undefined variable”.
- Note that the “system” folder is not included in the above variable search. When accessing a variable in the system folder, you need to specify the variable name only, without specifying the folder name.

Tip

- Local variables exist only as long as the program or user-defined function for which it was created in being executed.
- When a variable search is required during a subroutine called by a program or user-defined function, the local variable search range includes only the local variables of the subroutine currently being executed.
- For information about programs and user-defined functions, see Chapter 12.
- Only local variables and current folder variables are searched in the case of an operation that stores variable data or a command that performs an operation on a variable (like “DelVar”). Normally, “library” folder variables are not searched. If you want to include “library” folders in the search, you need to specify the “library” folder as the variable location as explained below.

■ Specifying a Variable in a Particular Folder

You can access a variable located inside the “main” folder, “library” folder, or a particular user folder by specifying the folder name along with the variable name. Use the following syntax when specifying a folder name:

<folder name>\<variable name>

Example: To specify variable “abc” located in the “main” folder
main\abc



1-8 Using the Variable Manager

The Variable Manager is a tool for managing user variables, programs, user functions, and other types of data. Though this section uses only the term “variables”, the explanations provided here also refer to the other types of data that can be managed by the Variable Manager.

Variable Manager Overview

This section explains how to start up and exit the Variable Manager. It also provides information about the configuration of the Variable Manager.

With the Variable Manager you can:

- Create, delete, rename, lock, and unlock folders for storing variables, and configure current folder settings.
- Delete, copy, rename, move, lock, unlock, search for variables, and view the contents of variables.

Starting Up the Variable Manager

To start up the Variable Manager, tap , and then tap [Variable Manager].

- Starting up the Variable Manager initially displays the folder list, which is described on the next page.



Variable Manager Views

The Variable Manager uses two views, a folder list and a variable list.

- The folder list always appears first whenever you start up the Variable Manager.

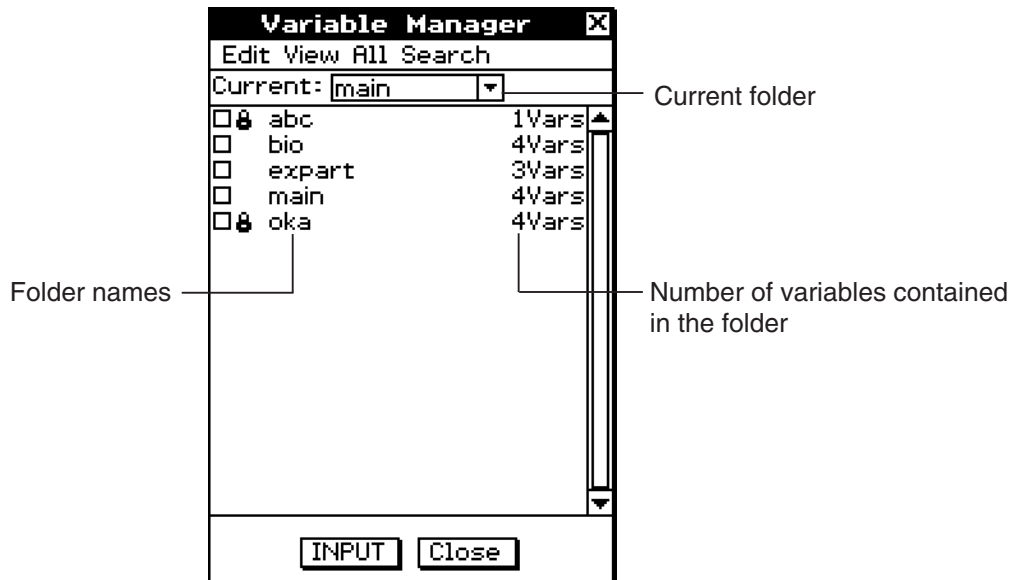

Folder List

- Tapping a folder name on the folder list selects it. Tapping the folder name again displays the folder's contents; a variable list.

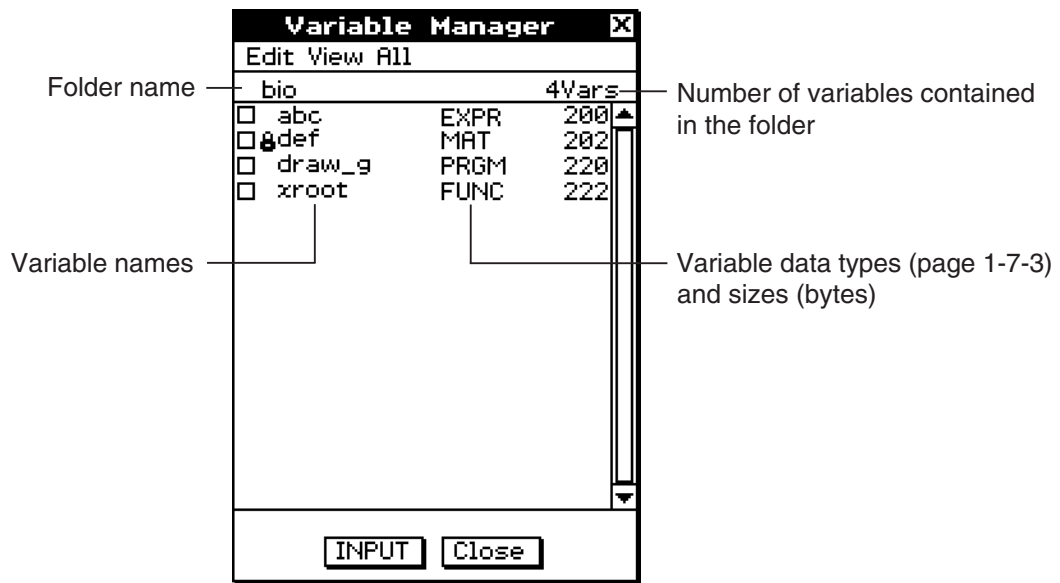

Variable List

- To close the variable list and return to the folder list, tap [Close].

Exiting the Variable Manager

To exit the Variable Manager, tap the [Close] button.



Variable Manager Folder Operations

This section describes the various folder operations you can perform using the Variable Manager.

■ Specifying the Current Folder

The “current folder” is the folder where the variables created by applications (excluding eActivity) are stored and from which such variables can be accessed. The initial default current folder is the “main” folder.

You can also select a folder you created yourself as the current folder.

● ClassPad Operation

(1) Start up the Variable Manager and display the folder list.



(2) Tap the [Current] down arrow button. On the list that appears, select the folder that you want to specify as the current folder.

(3) Tap [Close] to close the folder list.

■ Creating a New Folder

You can use the following procedure to create up to 87 folders, as you need them.

● ClassPad Operation

(1) Start up the Variable Manager, which causes the folder list to appear.

(2) On the folder list, tap [Edit] and then [Create Folder].

- This displays a dialog box for inputting a folder name.

(3) Enter the folder name, and then tap [OK].

- This creates the new folder and returns to the folder list.

- Normally, a folder name can contain up to eight bytes. If your folder name includes 2-byte characters, you may not be able to input eight characters for the folder name. For details about folder names, see page 1-7-5.

Tip

- An error message appears and your folder is not created if there is already a folder with the same name you input. Tap [OK] to close the error message dialog box, and then specify a different name for the folder you are creating.



■ Selecting and Deselecting Folders

The folder operations you perform are performed on the currently selected folders. The folders that are currently selected on the folder list are those whose check boxes are selected (checked). You can use the following operations to select and deselect folders as required.

To do this:	Do this:
Select a single folder	Select the check box next to the folder name.
Deselect a single folder	Clear the check box next to the folder name.
Select all the folders in the list	Tap [All] and then [Select All].
Deselect all the folders in the list	Tap [All] and then [Deselect All].

Tip

- If no check box is currently selected on the folder list, any folder operation that is performed affects the folder whose name is currently highlighted on the list. If any folder check box is currently selected, only that folder is affected by a folder operation, and the folder whose name is highlighted on the list is not affected.
- Selecting the check box of a folder causes the check boxes of all of the variables inside of it also to become selected.
- When renaming a folder, only the folder whose name is highlighted on the folder list is renamed. Other folders whose check boxes are selected are not affected.

■ Deleting a Folder

Warning!

Before deleting a folder, make sure you no longer need any of the variables contained inside it. It is probably a good idea to first delete the variables you don't need and move the variables you do need to another folder, and then delete the empty folder.

• ClassPad Operation

- (1) Start up the Variable Manager and display the folder list.
- (2) Open the folder you want to delete and check its contents.
 - Make sure you no longer need any of the variables in the folder. If any of the variables are locked, unlock them.
 - After checking the contents of the folder, close it to return to the folder list.
- (3) Select the check box next to the folder you want to delete.
 - You can select and delete multiple folders, if you want.
- (4) On the folder list, tap [Edit] and then [Delete].
- (5) In response to the confirmation dialog box that appears, tap [OK] to delete the folder or [Cancel] to exit the dialog box without deleting the folder.

**Tip**

- You cannot delete the “library” folder or the “main” folder.
- If no check box is currently selected on the folder list, the folder whose name is currently highlighted on the list is deleted when you tap [Edit] and then [Delete].
- An error message appears and the folder is not deleted if any one of the following conditions exists.
 - The folder is locked.
 - Any variable inside the folder is locked.
 - There are still variables inside the folder.

■ Renaming a Folder

You can use the following procedure to change the name of an existing folder.

● ClassPad Operation

- (1) Start up the Variable Manager and display the folder list.
- (2) Tap the name of the folder you want to rename so it is highlighted.
- (3) Tap [Edit] and then [Rename].
 - This displays a dialog box for inputting a new folder name.
- (4) Input the new folder name.
- (5) When the name is the way you want, tap [OK] to save it, or tap [Cancel] to cancel the rename procedure.

Tip

- When renaming a folder, only the folder whose name is highlighted on the folder list is renamed. Other folders whose check boxes are selected are not affected.
- A folder that is locked cannot be renamed.

■ Locking and Unlocking a Folder

A folder cannot be deleted or renamed while it is locked. Lock any folder that you want to protect against accidental deletion.

● To lock a folder

- (1) Start up the Variable Manager and display the folder list.
- (2) Select the check box next to the folder you want to lock.
 - If you want to lock multiple folders, select all of their check boxes.
- (3) Tap [Edit] and then [Lock].
 - This locks the currently selected folder, and adds a  icon to the left of its name to indicate that it is locked.

● To unlock a folder

- (1) Start up the Variable Manager and display the folder list.
- (2) Select the check box next to the folder you want to unlock.
- (3) Tap [Edit] and then [Unlock].



■ Inputting a Folder Name into an Application

Perform the procedure below when you want to input the name of a folder displayed on the Variable Manager window into the application from which you started up the Variable Manager.

● ClassPad Operation

- (1) In the Main application, Graph & Table application, or some other application, move the cursor to the location where you want to input the folder name.

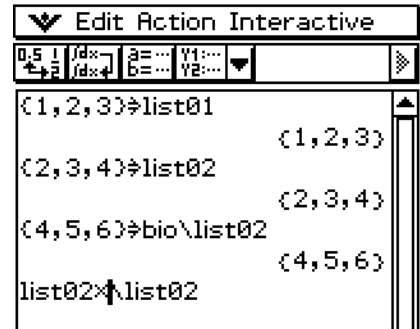

- (2) Start up the Variable Manager to display the list of folders.

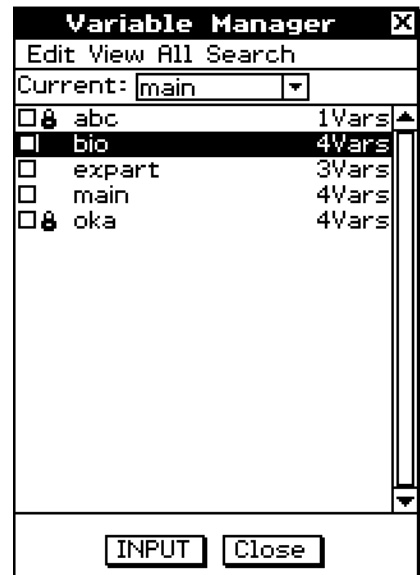

- (3) Tap the folder whose name you want to input, so the name is highlighted.

- (4) Tap [INPUT].

- This exits the Variable Manager and inputs the name of the folder you selected in step (3) into the application at the current cursor position.

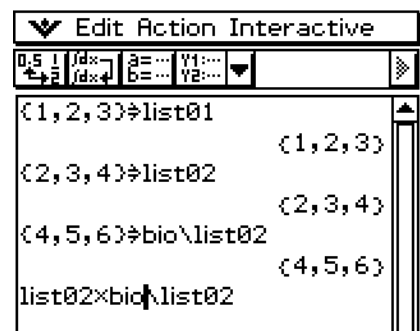



Variable Operations

This section explains the various operations you can perform on the Variable Manager variables.

■ Opening a Folder

Perform the steps below to open a folder and display the variables contained inside it.

● ClassPad Operation

- (1) Start up the Variable Manager and display the folder list.
- (2) Tap the name of the folder you want to open so it is highlighted, and then tap it again.
 - This opens the folder and displays a variable list showing its contents.
- (3) To return to the folder list, tap [Close].

■ Opening the “library” Folder

Note that the procedure you need to use to open the “library” folder is different from the procedure for opening other folders.

● ClassPad Operation

- (1) Start up the Variable Manager and display the folder list.
- (2) Tap [View] and then [“library” Folder].
 - This opens the “library” folder and displays a variable list showing its contents.
- (3) To return to the folder list, tap [Close].

Tip

- You can also open the “library” folder (by tapping [View] and then [“library” Folder]) while the variable list is on the display.

■ Displaying a List of a Particular Type of Variable

You can use the variable list to produce a list of a particular type of variable only.

● ClassPad Operation

- (1) In the Variable Manager, open any folder to display a variable list of its contents.
- (2) Tap [View] and then [Variable Type].
 - This displays the Variable Type dialog box for specifying the variable data type.

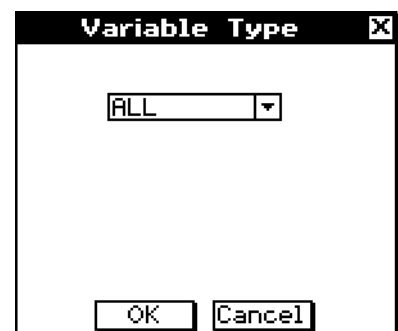



- (3) On the dialog box, tap the down arrow button and then select the data type from the list that appears.
 - To display variables for all data types, select [All].
 - For details about data type names and variables, see “Variable Data Types” on page 1-7-3.
- (4) After selecting the data type you want, tap [OK] to apply it or [Cancel] to exit the selection dialog box without changing the current setting.

Tip

- Returning to the folder list or exiting the Variable Manager causes the data type to change to the initial default setting, which is [All].
- Performing this operation clears the check boxes for all of the variables inside the applicable folder.

■ Selecting a Variable

Before you can copy, delete, or perform any other operation on a variable, you must first select it.

• To select or deselect a variable

- (1) In the Variable Manager, open any folder to display a variable list of its contents.
- (2) Perform one of the operations described below to select or deselect a variable.

To do this:	Do this:
Select a single variable	Select the check box next to the variable name.
Deselect a single variable	Clear the check box next to the variable name.
Select all the variables in the list	Tap [All] and then [Select All].
Deselect all the variables in the list	Tap [All] and then [Deselect All].

Tip

- If no check box is currently selected on the variable list, any variable operation that is performed affects the variable whose name is currently highlighted on the list. If any variable check box is currently selected, only that variable is affected by a variable operation, and the variable whose name is highlighted on the list is not affected.
- The selected/deselected status of a variable is retained, even when you return from the variable list to the folder list. Exiting the Variable Manager or changing the data type selection, however, causes all variables to be deselected.
- When renaming a variable, only the variable whose name is highlighted on the variable list is renamed. If other variables are selected (checked), they will not be affected.



■ Deleting a Variable

Perform the following steps when you want to delete a variable.

● ClassPad Operation

- (1) Open the folder that contains the variable you want to delete and display the variable list.
- (2) Select the check box next to the variable you want to delete.
 - To delete multiple variables, select all of their check boxes.
- (3) Tap [Edit] and then [Delete].
- (4) In response to the confirmation dialog box that appears, tap [OK] to delete the selected variable or [Cancel] to cancel the delete operation.

Tip

- If no check box is selected on the variable list, the variable whose name is currently highlighted on the list is deleted when you tap [Edit] and then [Delete].
- If the currently selected variable is locked, an error message appears and the variable is not deleted.

■ Copying and Moving a Variable

You can use the procedure below to copy or move a variable to another folder.

● ClassPad Operation

- (1) Open the folder that contains the variable you want to copy or move, and display the variable list.
- (2) Select the check box next to the variable you want to copy or move.
 - To copy or move multiple variables, select all of their check boxes.
- (3) Perform the copy operation or the move operation.

To do this:	Perform this operation:
Copy the variable	Tap [Edit] and then [Copy].
Move the variable	Tap [Edit] and then [Move].

- This causes a dialog box for selecting the destination folder to appear.

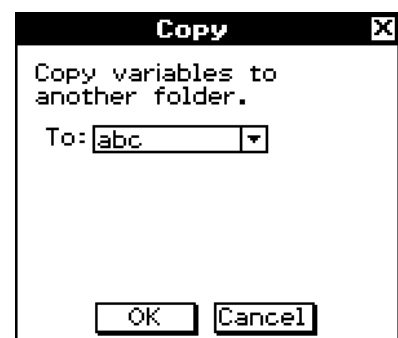

- (4) On the dialog box, tap the down arrow button and then select the destination folder from the list that appears.
- (5) When the destination folder you want is selected, tap [OK] to perform the copy or move operation, or tap [Cancel] to cancel the procedure.

**Tip**

- If no check box is currently selected on the variable list, the variable whose name is currently highlighted on the list is copied or moved.
- If a variable with the same name already exists in the destination folder, the variable in the destination folder is replaced with the one that you are copying or moving.
- An error message appears and the variable is not copied or moved if a variable with the same name already exists in the destination folder and that variable is locked or protected.
- A variable that is locked cannot be moved.

■ Renaming a Variable

Perform the following steps when you want to rename a variable.

• ClassPad Operation

- (1) Open the folder that contains the variable you want to rename and display the variable list.
- (2) Tap the name of the variable you want to rename so it is highlighted.
- (3) Tap [Edit] and then [Rename].
 - This displays a dialog box for inputting a new variable name.
- (4) Input the new variable name.
- (5) When the name is the way you want, tap [OK] to save it, or tap [Cancel] to cancel the rename procedure.

Tip

- When renaming a variable, only the variable whose name is highlighted on the variable list is renamed. Other variables whose check boxes are selected are not affected.
- A variable that is locked cannot be renamed.

■ Locking and Unlocking a Variable

A locked variable cannot be deleted, moved, or renamed. A locked variable also cannot be overwritten by a variable with the same name being moved or copied into its folder. Lock any variable that you want to protect against accidental deletion.

• To lock a variable

- (1) Open the folder that contains the variable you want to lock and display the variable list.
- (2) Select the check box next to the variable you want to lock.
 - If you want to lock multiple variables, select all of their check boxes.
- (3) Tap [Edit] and then [Lock].
 - This locks the currently selected variable, and adds a  icon to the left of its name to indicate that it is locked.



• To unlock a variable

- (1) Open the folder that contains the variable you want to unlock and display the variable list.
- (2) Select the check box next to the variable you want to unlock.
- (3) Tap [Edit] and then [Unlock].

■ Searching for a Variable

You can use the following procedure to search the “main” folder or a user defined folder for a particular variable name. Note that you cannot search the “library” folder.

• ClassPad Operation

- (1) Start up the Variable Manager and display the folder list.
- (2) On the folder list, tap [Search] and then [Search].
 - This displays a dialog box for inputting a search string.
- (3) Enter the variable name you want to find and then tap [OK].
 - An exclamation point (!) appears in front of all folders containing a variable name that matches the name in your search.

<input type="checkbox"/>	<input checked="" type="checkbox"/>	abc	1Vars
<input type="checkbox"/>	<input type="checkbox"/>	bio	4Vars
<input type="checkbox"/>	<input type="checkbox"/>	expart	3Vars
<input type="checkbox"/>	<input type="checkbox"/>	main	4Vars
<input type="checkbox"/>	<input checked="" type="checkbox"/>	!oka	4Vars

Tip

- The message “Not Found” appears on the display if a match cannot be found.
- The exclamation point (!) remains on the folder list until you exit the Variable Manager or perform another search operation. Also note that the exclamation point (!) remains in front of the folder name, even if you delete or rename the found variable.



■ Viewing the Contents of a Variable

You can use the Variable Manager to view the contents of a particular variable.

● ClassPad Operation

- (1) Open the folder that contains the variable whose contents you want to view and display on the variable list.
- (2) Tap the name of the variable whose contents you want to view so it is highlighted, and then tap it again.
 - This displays a dialog box that shows the contents of the variable.

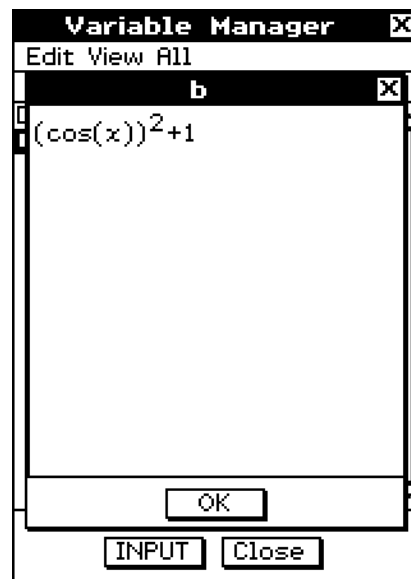

Example of EXPR variable contents

- (3) To close the dialog box, tap [OK].

Tip

- You can use this procedure to display the contents of the following variable types only: EXPR, STR, LIST, MAT, FUNC, PRGM, TEXT, PICT.



■ Inputting a Variable Name into an Application

Perform the procedure below when you want to input the name of a variable from the Variable Manager window into the application from which you started up the Variable Manager.

● ClassPad Operation

- (1) In the Main application, Graph & Table application, or some other application, move the cursor to the location where you want to input the variable name.

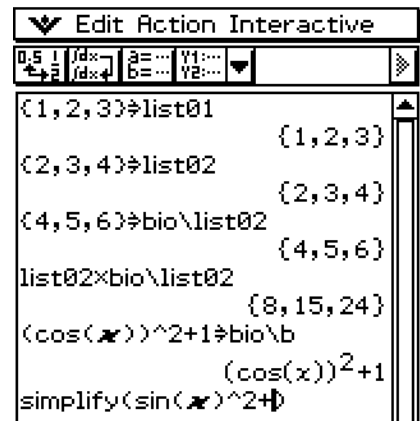

- (2) Start up the Variable Manager to display the folder list.

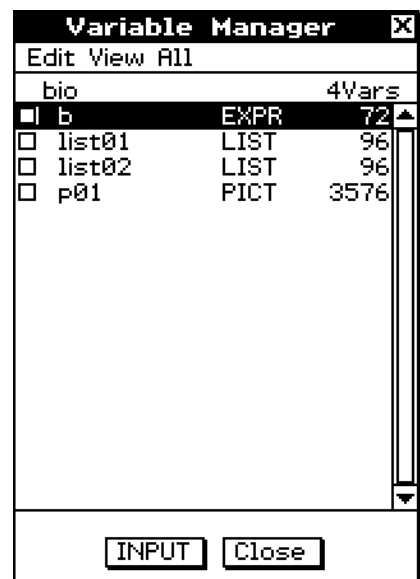

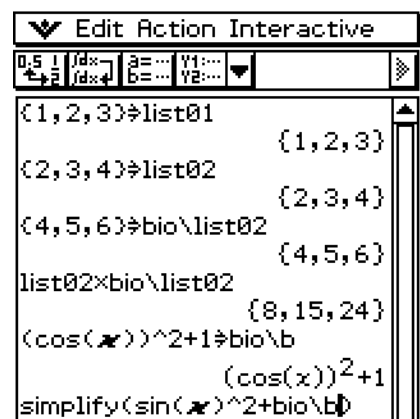

- (3) Find the name of the folder that contains the variable whose name you want to input, and tap it twice.
- (4) Tap the variable whose name you want to input, so its name is highlighted.
- (5) Tap [INPUT].

- This exits the Variable Manager and inputs the name of the variable you selected in step (4) into the application at the current cursor position.
- In this example, the variable is located in a folder (bio) that is not the current folder, so the folder name needs to be specified (bio\list02). If the variable is located in the current folder, you do not need to specify the folder name (list02).







1-9 Configuring Application Format Settings



The  menu includes format settings for configuring the number of calculation result display digits and the angle unit, as well as application-specific commands. The following describes each of the settings and commands that are available on the  menu.

To do this:	Select this  menu command:
Specify folder for variables, and to configure number format, angle, and other basic settings for all built-in applications	Basic Format
Configure Graph window and graph drawing settings for Graph & Table, Conics, and other graphing applications	Graph Format
Configure 3D Graph window and graph drawing settings for the 3D Graph application	3D Format
Configure number format and angle settings for Geometry application	Geometry Format
Configure Fourier transform and FFT settings	Advanced Format
Configure Financial application settings	Financial Format
Configure Presentation application settings	Presentation
Configure Communication application settings	Communication
Return all [Setup] menu settings to their initial default values (except for the current folder setting specified on Basic Format dialog box)	Default Setup

Tip

- For more details about the structure and content of the  menu, see “Using the  Menu” on page 1-5-4.

• ClassPad Operation

- (1) Open any application (except the System application).
- (2) Tap .
- (3) Tap the menu command you want: Basic Format, Graph Format, 3D Format, Geometry Format, Advanced Format, Financial Format, Presentation, or Communication.
 - To configure Graph Format settings, for example, tap  and then [Graph Format]. This displays the Graph Format dialog box.
 - Some setup dialog boxes contain multiple tabbed sheets like the Graph Format dialog box. Tap the tab for the sheet that contains the settings you want to configure.
- (4) Use the dialog box to configure the settings you want.
 - For details about the settings you can configure on each of the dialog boxes, see “Application Format Settings” on page 1-9-4.
 - Some settings require specification of a variable. For more information, see “Specifying a Variable” on the next page.
- (5) To close a dialog box and apply its settings, tap [Set]. To close a dialog box without applying its settings, tap [Cancel] or the  button in the upper right corner of the dialog box.





Specifying a Variable

Certain settings require that you specify variables. If you specify a user-stored variable when configuring the setting of such an item, you must specify the folder where the variable is stored and the variable name.

Example: To use [Table Variable] on the [Special] tab of the Graph Format dialog box for configuring a user variable

• ClassPad Operation

- (1) Tap , or tap  on the icon panel, and then tap [Graph Format].
 - This displays the Graph Format dialog box.
- (2) Tap the [Special] tab.
- (3) Tap the [Table Variable] down arrow button.
 - This displays a list of variables.

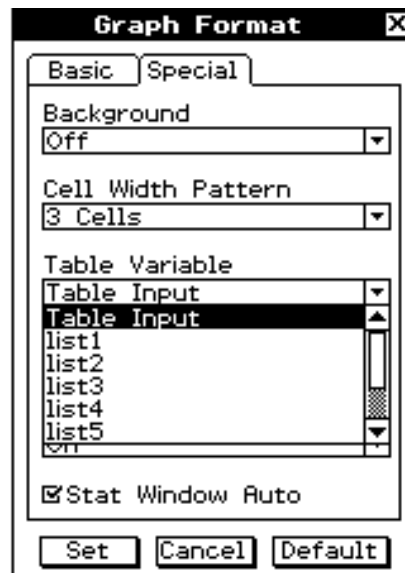

- (4) On the list, tap “Select List Name...”.
 - This displays the Select Data dialog box for selecting a variable.

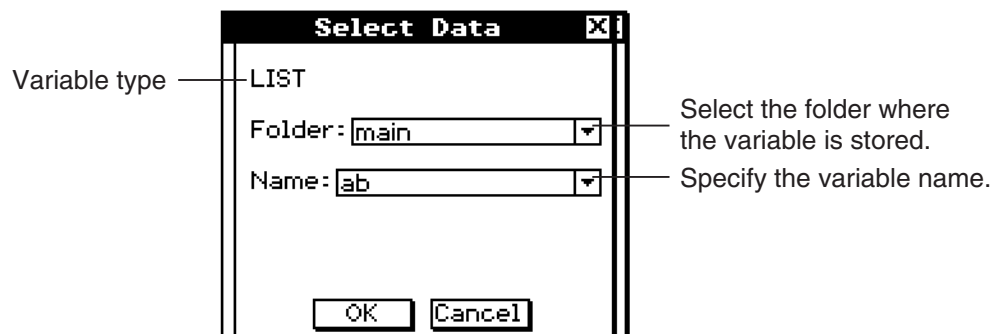



(5) Use the Select Data dialog box to specify the folder where the variable is saved, and then specify the variable name.

- The sample dialog box in step (4) shows selection of the list variable named “ab”, which is located in the folder named “main”.

(6) Tap [OK].

- This closes the Select Data dialog box.

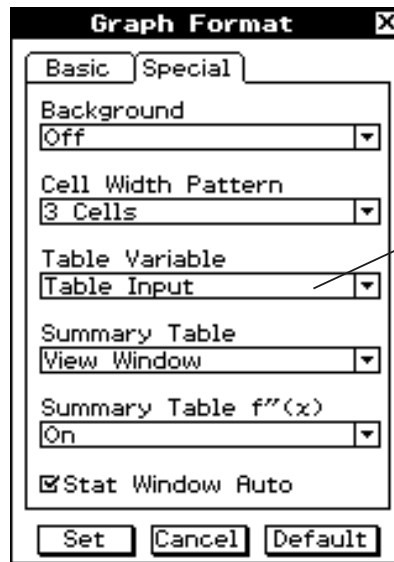



This line shows the <folder name>\<variable name> specified in step (5) (“main\ab” in this case). This box indicates that “main\ab” is selected for Table Variable.

(7) Tap [Set] to save your settings.

Initializing All Application Format Settings

Perform the following procedure when you want to return all application format settings to their initial defaults.

• ClassPad Operation

- (1) Tap , or tap  on the icon panel, and then tap [Default Setup].
- (2) In response to the “Reset Setup Data?” message that appears, tap [OK] to initialize all settings or [Cancel] to cancel the reset operation.
 - If you tap [OK], the settings are initialized and then a dialog box appears on the display.
 - For details about the initial default setting for each item, see “Application Format Settings” on page 1-9-4.

Tip

- Initializing the application format settings does not affect the current folder setting on the Basic Format dialog box. For details about the current folder, see “Specifying the Current Folder” on page 1-8-3.



Application Format Settings

This section provides details about all of the settings you can configure using the application format settings.

The following two points apply to all of the dialog boxes.

- Some settings involve turning options on or off. Selecting a check box next to an option (so it has a check mark) turns it on, while clearing the check box turns it off.
- Other settings consist of a text box with a down arrow button on the right. Tap the down arrow button to display a list of available settings, and then tap the setting you want.

Important!

- Settings that are marked with an asterisk (*) in the following tables are the initial defaults.

■ Basic Format Dialog Box

Use the Basic Format dialog box to configure basic settings for calculations, cells, and other parameters.

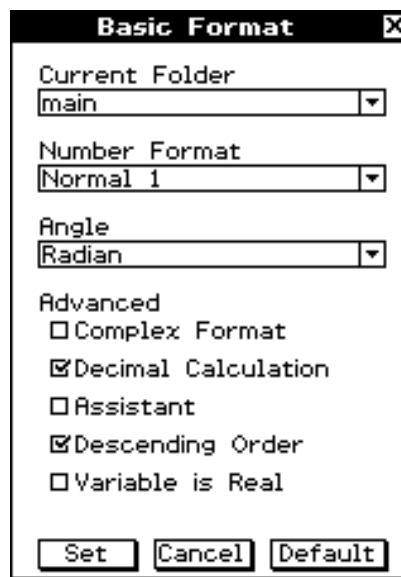

- Current Folder

To specify this folder as the current folder:	Select this setting:
main	main*
A user-defined folder	Any other setting

- [Current Folder] settings can also be configured using the Variable Manager. For more information, see “Specifying the Current Folder” on page 1-8-3.



- Number Format

To specify this type of numeric value display format:	Select this setting:
Auto exponential display for values less than 10^{-2} and from 10^{10} or greater (when you are in the Decimal mode)	Normal 1*
Auto exponential display for values less than 10^{-9} and from 10^{10} or greater (when you are in the Decimal mode)	Normal 2
Fixed number of decimal places	Fix 0 – 9
Fixed number of significant digits	Sci 0 – 9

- Angle

To specify this angle unit:	Select this setting:
Radians	Radian*
Degrees	Degree
Grad	Grad

- Advanced

To do this:	Do this:
Perform complex number calculations (Complex mode)	Select the [Complex Format] check box.
Perform real number calculations (Real mode)	Clear the [Complex Format] check box.*
Display results as a decimal (Decimal mode)* ¹	Select the [Decimal Calculation] check box.
Leave calculation results as expressions (Standard mode)* ¹	Clear the [Decimal Calculation] check box.*
Turn off auto simplification of expressions (Assistant mode)* ²	Select the [Assistant] check box.
Turn on auto simplification of expressions (Algebra mode)* ²	Clear the [Assistant] check box.*
Specify descending order (e.g. $x^2 + x + 1$) for the calculation result expression	Select the [Descending Order] check box.*
Specify ascending order (e.g. $1 + x + x^2$) for the calculation result expression	Clear the [Descending Order] check box.
Specify that variables in Complex Mode calculation should be treated as real numbers • With this setting, $\text{re}(a+bi)=a$ and $\text{im}(a+bi)=b$.	Select the [Variable is Real] check box.
Specify that variables in Complex Mode calculation should be treated as complex numbers	Clear the [Variable is Real] check box.*

*1 Executing $1 \div 2$ in the Decimal mode produces a result of 0.5, while the Standard mode produces a result of $\frac{1}{2}$.

*2 Executing $x^2 + 2x + 3x + 6$ (EXE) in the Assistant mode produces a result of $x^2 + 2 \cdot x + 3 \cdot x + 6$, while the Algebra mode produces a result of $x^2 + 5 \cdot x + 6$.

Important!

The Assistant mode is available in the Main application and eActivity application only.



■ Graph Format Dialog Box

Use the Graph Format dialog box to configure settings for the Graph window and for drawing graphs.

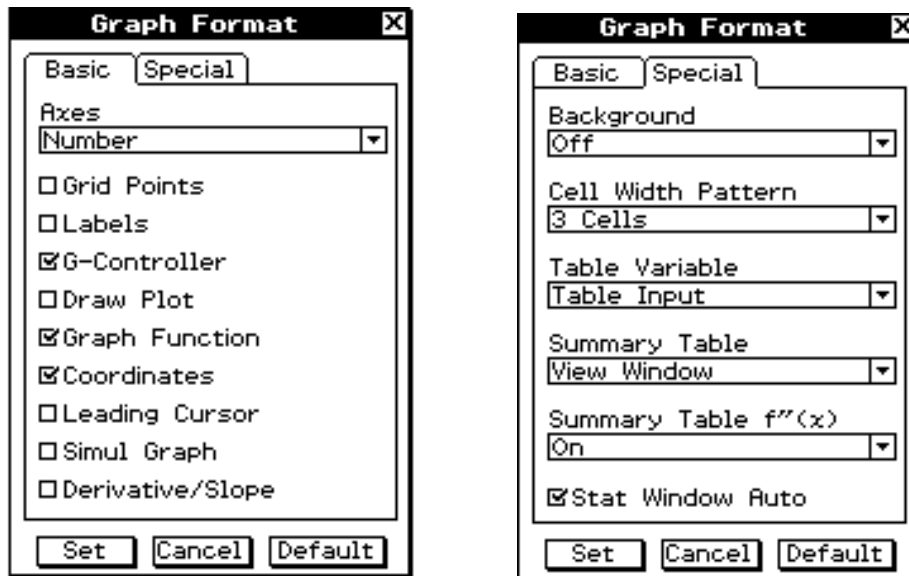

Basic Tab

● Axes

To do this:	Select this setting:
Turn on display of Graph window axes	On*
Turn on display of Graph window axes along with maximum and minimum value of each axis	Number
Turn off display of Graph window axes	Off

● Other settings

To do this:	Do this:
Turn on display of Graph window grid	Select the [Grid Points] check box.
Turn off display of Graph window grid	Clear the [Grid Points] check box.*
Turn on display of Graph window axis labels	Select the [Labels] check box.
Turn off display of Graph window axis labels	Clear the [Labels] check box.*
Turn on display of graph controller arrows during graphing	Select the [G-Controller] check box.
Turn off display of graph controller arrows during graphing	Clear the [G-Controller] check box.*
Draw graphs with plotted points	Select the [Draw Plot] check box.
Draw graphs with solid lines	Clear the [Draw Plot] check box.*
Turn on display of function name and function	Select the [Graph Function] check box.*
Turn off display of function name and function	Clear the [Graph Function] check box.



To do this:	Do this:
Turn on display of Graph window pointer coordinates	Select the [Coordinates] check box.*
Turn off display of Graph window pointer coordinates	Clear the [Coordinates] check box.
Turn on display of leading cursor during graphing	Select the [Leading Cursor] check box.
Turn off display of leading cursor during graphing	Clear the [Leading Cursor] check box.*
Draw multiple graphs simultaneously	Select the [Simul Graph] check box.
Draw multiple graphs one-by-one	Clear the [Simul Graph] check box.*
Turn on display of coordinates of Graph window pointer and its derivative on number table display	Select the [Derivative/Slope] check box.
Turn off display of coordinates of Graph window pointer and its derivative on number table display	Clear the [Derivative/Slope] check box.*

Special Tab

• Background

To do this:	Select this setting:
Turn off Graph window background display	Off*
Select an image to be used as Graph window background	<pict name>

• Cell Width Pattern

To specify this row width for stat editor and data table displays:	Select this setting:
2 cells	2 Cells
3 cells	3 Cells*
4 cells	4 Cells

• Table Variable

To specify this source for table data:	Select this setting:
Table input	Table input*
List data	list1 through list6
Select list data to be used as source for table data	<list name>

• Summary Table

To specify this source for summary table data:	Select this setting:
View Window	View Window*
List data	list1 through list6
Select list data to be used as source for summary table data	<list name>

• Summary Table $f''(x)$

To do this:	Select this setting:
Turn on display of second derivative for summary tables	On*
Turn off display of second derivative for summary tables	Off



• Stat Window Auto

To do this:	Do this:
Configure Statistics application View Window settings automatically	Select the [Stat Window Auto] check box.*
Configure Statistics application View Window settings manually	Clear the [Stat Window Auto] check box.

■ 3D Format Dialog Box

Use the 3D Format dialog box to configure settings for the 3D Graph window and for drawing 3D graphs. For full details about the 3D Graph application, see Chapter 5.

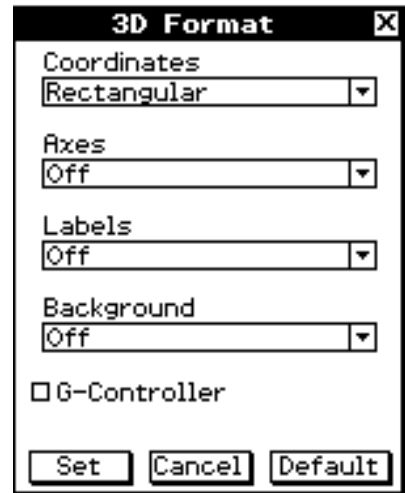

• Coordinates

To do this:	Select this setting:
Display coordinate values using rectangular coordinates	Rectangular*
Display coordinate values using polar coordinates	Polar
Turn off display of coordinates	Off

• Axes

To do this:	Select this setting:
Display axes normally	On
Display box type coordinate axes	Box
Turn off display of axes	Off*

• Labels

To do this:	Select this setting:
Turn on display of Graph window axis labels	On
Turn off display of Graph window axis labels	Off*

• Background

To do this:	Select this setting:
Turn off Graph window background display	Off*
Select an image to be used as the Graph window background	<pict name>

• The above is the same as the [Background] setting on the Graph Format dialog box.



- G-Controller

To do this:	Do this:
Turn on display of graph controller arrows during graphing	Select the [G-Controller] check box.
Turn off display of graph controller arrows during graphing	Clear the [G-Controller] check box.*

- The above is the same as the [G-Controller] setting on the Graph Format dialog box.

■ Geometry Format Dialog Box

Use the Geometry Format dialog box to configure settings for the Geometry application.

Tip

- The information that appears in the preview area at the bottom of the dialog box shows a preview of the Geometry application window, based on the settings configured in upper half of the dialog box.

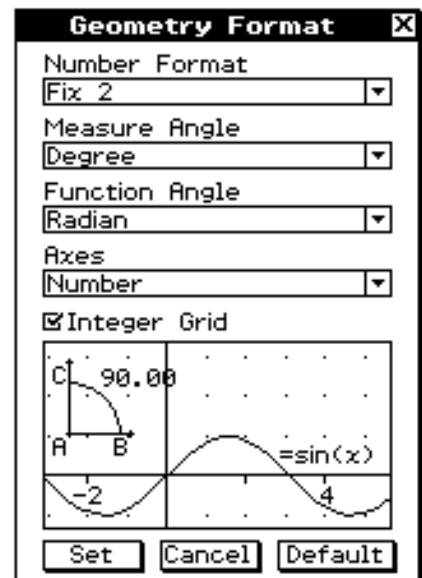

- Number Format

To specify this type of numeric value display format on the Geometry window:	Select this setting:
Auto exponential display for values less than 10^{-2} and from 10^{10} or greater (when you are in the Decimal mode)	Normal 1
Auto exponential display for values less than 10^{-9} and from 10^{10} or greater (when you are in the Decimal mode)	Normal 2
Fixed number of decimal places	Fix 0 – 9
Fixed number of significant digits	Sci 0 – 9

- The initial default [Number Format] setting is Fix 2.



- Measure Angle

To specify the angle unit for the measurement box:	Select this setting:
Radian	Radian
Degree	Degree*
Grad	Grad

- Function Angle

To specify the angle unit for graphing:	Select this setting:
Radian	Radian*
Degree	Degree
Grad	Grad

- Axes

To set the initial Graph window axes condition when opening the Geometry application:	Select this setting:
Turn on display of Graph window axes	On
Turn on display of Graph window axes along with maximum and minimum value of each axis	Number
Turn off display of Graph window axes	Off*

- Integer Grid

To set the initial condition of integer grid when opening the Geometry application:	Do this:
Turn on display of integer grid	Select the [Integer Grid] check box.
Turn off display of integer grid	Clear the [Integer Grid] check box.*



Advanced Format Dialog Box

Use the Advanced Format dialog box to configure settings for Fourier transform and FFT settings.

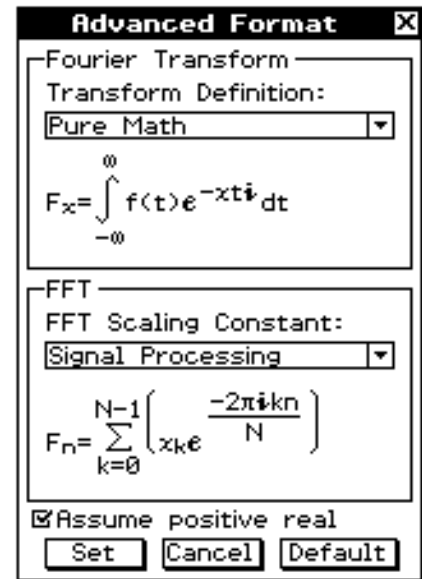

Fourier Transform

To do this:	Select this setting:
Specify following formula for Fourier transform: $F_x = \int_{-\infty}^{\infty} f(t) e^{-xtj} dt$	Pure Math*
Specify following formula for Fourier transform: $F_x = \frac{1}{\sqrt{2\pi}} \int_{-\infty}^{\infty} f(t) e^{xtj} dt$	Modern Physics
Specify following formula for Fourier transform: $F_x = \frac{1}{2\pi} \int_{-\infty}^{\infty} f(t) e^{xtj} dt$	Classical Physics
Specify following formula for Fourier transform: $F_x = \int_{-\infty}^{\infty} f(t) e^{xtj} dt$	Probability
Specify following formula for Fourier transform: $F_x = \int_{-\infty}^{\infty} f(t) e^{-2\pi x t j} dt$	Signal Processing

FFT

To do this:	Select this setting:
Specify Pure Math for FFT scaling constant	Pure Math
Specify Signal Processing for FFT scaling constant	Signal Processing*
Specify Data Analysis for FFT scaling constant	Data Analysis

Assume positive real

To do this:	Do this:
Assume variables for Fourier calculation are positive reals	Select the [Assume positive real] check box.*
Allow complex numbers as variables for Fourier calculation	Clear the [Assume positive real] check box.



■ Financial Format Dialog Box

Use the Financial Format dialog box to configure settings for the Financial application.

Basic Tab

● Days in Year

To do this:	Select this setting:
Specify a 360-day year	360 days*
Specify a 365-day year	365 days

● Payment Date

To do this:	Select this setting:
Specify beginning of period for the payment date	Beginning of period
Specify end of period for the payment date	End of period*

● Date Format

To do this:	Select this setting:
Specify day/month/year as the date format	DD/MM/YYYY
Specify month/day/year as the date format	MM/DD/YYYY*
Specify year/month/day as the date format	YYYY/MM/DD

● Automatically copy common fields to new calculation

To do this:	Do this:
When changing to another calculation type, automatically copy the contents of all fields in the current calculation whose names match the names of fields in the new calculation	Select [Automatically copy common fields to new calculation] check box.
When changing to another calculation type, clear all fields	Clear [Automatically copy common fields to new calculation] check box.*



Special Tab

• Odd Period

To do this:	Select this setting:
Specify compound interest for odd (partial) months	Compound (CI)
Specify simple interest for odd (partial) months	Simple (SI)
Specify no separation of full and odd (partial) months	Off*

• Compounding Frequency

To do this:	Select this setting:
Specify once a year compounding	Annual*
Specify twice a year compounding	Semi-annual

• Bond Interval

To do this:	Select this setting:
Use a number of payments as term for bond calculations	Term*
Use a date as term for bond calculations	Date

• Profit Amount/Ratio

To do this:	Select this setting:
Use amount (PRF) for break-even point calculations	Amount (PRF)*
Use profit ratio ($r\%$) for break-even point calculations	Ratio ($r\%$)

• Break-Even Value



To do this:	Select this setting:
Use quantity for break-even point calculations	Quantity*
Use sales amount for break-even point calculations	Sales



■ Presentation Dialog Box

Use the Presentation dialog box to configure settings for the Presentation application. For full details about the Presentation application, see Chapter 11.



To do this:	Do this:
Send hard copy data to an external device	Select "Outer Device" for [Screen Copy To].*
Save hard copy data internally as Presentation data	Select "P1:<File name>*" through "P20:<File name>*" for [Screen Copy To].
Specify the page change speed for Auto Play	Specify a [Play Speed] value from 1 (fastest) to 10 (slowest).
Capture the upper half of the window when  is tapped	Select the [Half Screen Capturing] check box.
Capture the entire window when  is tapped	Clear the [Half Screen Capturing] check box.*
Turn on repeat playback of files	Select the [Repeat] check box.
Turn off repeat playback of files	Clear the [Repeat] check box.*
Turn on page number display during playback and editing	Select the [Page Number] check box.*
Turn off page number display during playback and editing	Clear the [Page Number] check box.

- The initial default [Play Speed] setting is 4.

** <File name> will show the name of the presentation file.



■ Communication Dialog Box

Use the Communication dialog box to configure communication settings. For full details about the Communication application, see Chapter 17.

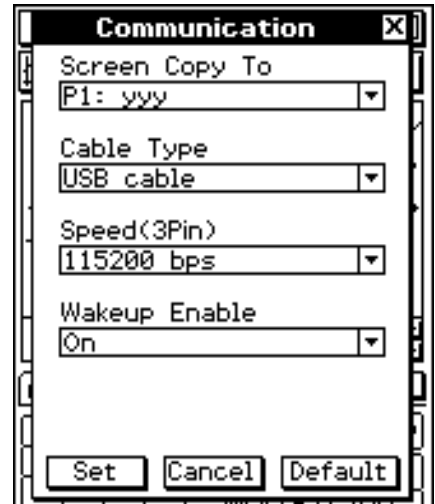

● Screen Copy To

To do this with hard copy data generated by tapping  :	Select this setting:
Send hard copy data to an external device	Outer Device*
Save hard copy data internally as Presentation data	P1 - P20

● Cable Type

To use this type of cable for data communication:	Select this setting:
3-pin cable	3pin cable
USB cable	USB cable*

● Speed (3Pin)

To specify this data rate for 3-pin communication:	Select this setting:
9,600 bps	9600 bps
38,400 bps	38400 bps
115,200 bps	115200 bps*

● Wakeup Enable

To do this:	Select this setting:
Turn on the wakeup function (page 17-3-2)	On*
Turn off the wakeup function	Off

Using the Main Application

The Main application is a general-purpose numerical and mathematical calculation application that you can use to study mathematics and solve mathematical problems. You can use the Main application to perform general operations from basic arithmetic calculations, to calculations that involve lists, matrices, etc.

The Main application also provides you with an [Action] menu and [Interactive] menu from which you can select approximately 120 different commands for working with mathematical expressions.

- 2-1 Main Application Overview**
- 2-2 Basic Calculations**
- 2-3 Using the Calculation History**
- 2-4 Function Calculations**
- 2-5 List Calculations**
- 2-6 Matrix and Vector Calculations**
- 2-7 Specifying a Number Base**
- 2-8 Using the Action Menu**
- 2-9 Using the Interactive Menu**
- 2-10 Using the Main Application in Combination with Other Applications**
- 2-11 Using Verify**
- 2-12 Using Probability**
- 2-13 Running a Program in the Main Application**

2-1 Main Application Overview

This section provides information about the following.

- Main application windows
- Modes that determine how calculations and their results are displayed
- Menus and their commands

Starting Up the Main Application

Use the following procedure to start up the Main application.

• ClassPad Operation

On the application menu, tap .

This starts the Main application and displays the work area.

Main Application Window

Starting up the Main application displays a large white work area.

Work area
Use this area for inputting operations and commands. ClassPad also uses this area to output calculation results.

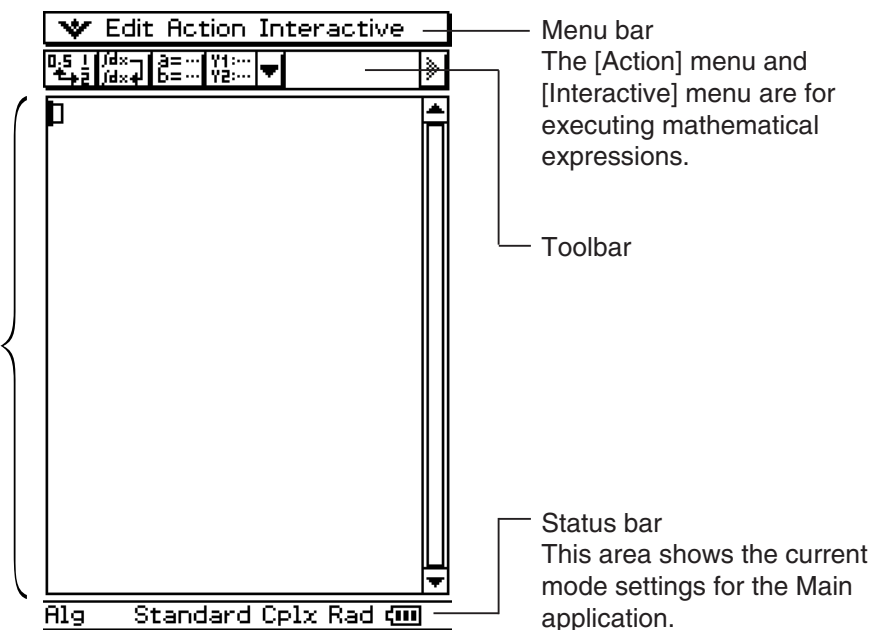

- Basic Main application operations consist of inputting a calculation expression into the work area and pressing EXE . This performs the calculation and then displays its result on the right side of the work area.

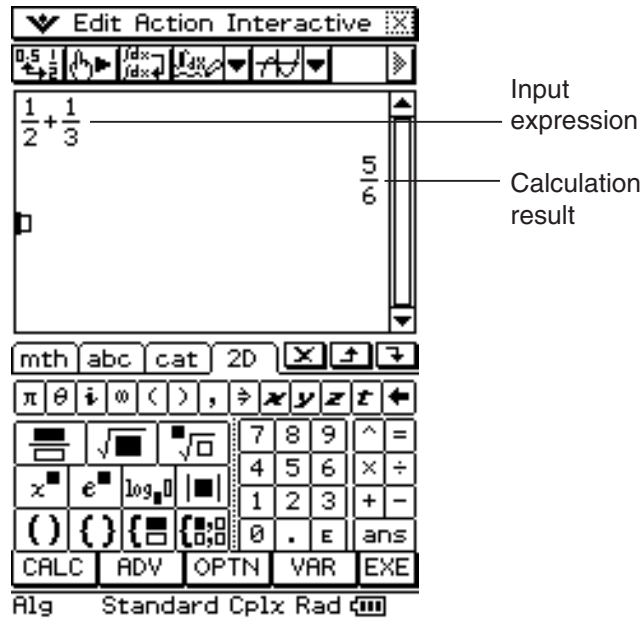

- Calculation results are displayed in natural format, with mathematical expressions appearing just as they do in your textbook. You can also input expressions in natural format using the 2D soft keyboard.
- The Main application also has a calculation history feature, which saves up to 30 calculation expressions you input and their calculated results. As long you do not clear the record, this information is available for later recall. This way you can recall a past calculation, make changes to it, and recalculate.



Main Application Menus and Buttons





This section explains the operations you can perform using the menus and buttons of the Main application.

- For information about the  menu, see “Using the  Menu” on page 1-5-4.

Menu Commands

To do this:	Select this menu item:
Undo the last operation or redo an operation that was just undone	Edit - Undo/Redo
Cut the selected character string and place it onto the clipboard	Edit - Cut
Copy the selected character string and place it onto the clipboard	Edit - Copy
Paste the contents of the clipboard at the current cursor position in the work area	Edit - Paste
Select the entire row (input expression or value, or result) where the cursor is located in the work area	Edit - Select All
Delete the input expression and its result where the cursor is located in the work area	Edit - Delete
Clear variables that contain numbers, list and matrices	Edit - Clear All Variables
Clear all work area contents (calculation history)	Edit - Clear All
Insert a command into the work area (page 2-8-1)	Action
Execute an Interactive command for the expression selected in the work area (page 2-9-1)	Interactive

Button Functions

To do this:	Tap this button:
Toggle calculation result display between the Standard mode and Decimal mode	
Recalculate the equation just for the current line where the cursor is currently located	
Output an input expression as-is*	
Switch between binary, octal, decimal or hexadecimal number bases during normal calculation (page 2-7-3)	
Access ClassPad application windows from the Main application (page 2-1-5)	

* Normally, inputting and executing an expression like $\int (x \times \sin(x), x)$ integrates $x \times \sin(x)$ and displays the result $\sin(x) - x \times \cos(x)$. Tapping  displays $\int (x \times \sin(x), x)$ as-is, in a natural math format without performing any calculation.



Using Main Application Modes

The Main application has a number of different modes that control how calculation results are displayed, as well as other factors. The current mode is indicated in the status bar.

■ Status Bar Mode Indicators

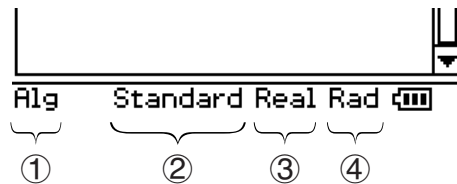

Settings that are marked with an asterisk (*) in the following tables are initial defaults.

Status Bar Location	Indicator	Description	Setting	Status
①	Assist	Assistant mode: Does not automatically simplify expressions.	Assistant	On
	Alg	Algebra mode: Automatically simplifies expressions.		Off*
②	Decimal	Decimal mode: Converts result to a decimal (approximate value).	Decimal Calculation	On
	Standard	Standard mode: Displays result in exact form (fractional format). If a result cannot be displayed in exact form, however, it will be displayed as a decimal approximation.		Off*
③	Cplx	Complex mode: For complex number calculations.	Complex Format	On
	Real	Real mode: For real number calculations.		Off*
④	Rad	Radian mode: Angles displayed in radians.	Angle	Radian*
	Deg	Degree mode: Angles displayed in degrees.		Degree
	Gra	Grad mode: Angles displayed in grads.		Grad

- You can tap a mode name in the status bar to change it, or use the menu's [Basic Format] command to change the setting of each mode. For details about these settings, see "1-9 Configuring Application Format Settings".
- For details about the calculations and result displays produced in each of the above modes, see "Calculation Modes" on page 2-2-6.





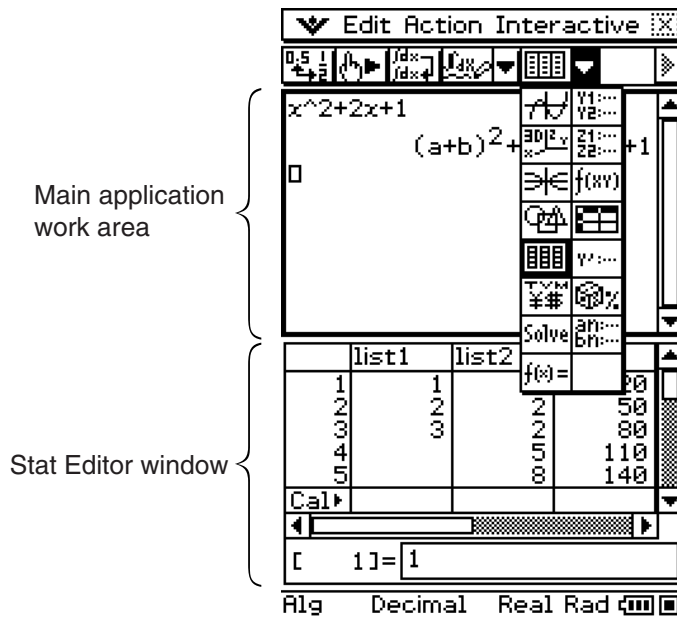









Accessing ClassPad Application Windows from the Main Application

Tapping the down arrow button on the toolbar displays a palette of 15 icons that you can use to access certain windows of other ClassPad applications. Tapping the  button, for example, splits the display into two windows, with the Stat Editor window of the Statistics application in the lower window.





- For details about swapping the positions of the two windows, activating a window, closing a window, etc, see “Using a Dual Window Display” on page 1-5-1.

The following table displays the application you can access with each of the buttons.

To display this window:	Tap this button:	See Chapter:
Graph & Table application Graph window		3
Graph & Table application Graph Editor window		3
3D Graph application 3D Graph window		5
3D Graph application 3D Graph Editor window		5
Conics application Conics Graph window		4
Conics application Conics Editor window		4
Geometry application Geometry window		8
Spreadsheet application window		13
Statistics application Stat Editor window		7
Differential Equation application Differential Equation Editor window		14
Financial application window		15
Probability window		See “2-12 Using Probability”.
Numeric Solver application Numeric Solver window		9
Sequence application Sequence Editor window		6
Verify window		See “2-11 Using Verify”.

- You can perform drag and drop operations with expressions between the Main application work area and the currently displayed window. For example, you could drag an expression from the Main application work area to the Graph window, and graph the expression. For details, see “2-10 Using the Main Application in Combination with Other Applications”.
- For details about how to use each type of window, see the chapter for the appropriate application.

Accessing the Main Application Window from Another ClassPad Application

Some ClassPad applications allow you to access the Main application window by tapping  and then [Main]. In the Statistics application and some other applications, you can also access the Main application window by tapping the  button.

The following are examples of what you can do after opening the Main application window within another application.

- Using the Main application window as a calculator to perform a simple calculation
- Using drag and drop to copy expressions and values between windows

Example: To drag an expression from the Graph Editor window to the Main application work area

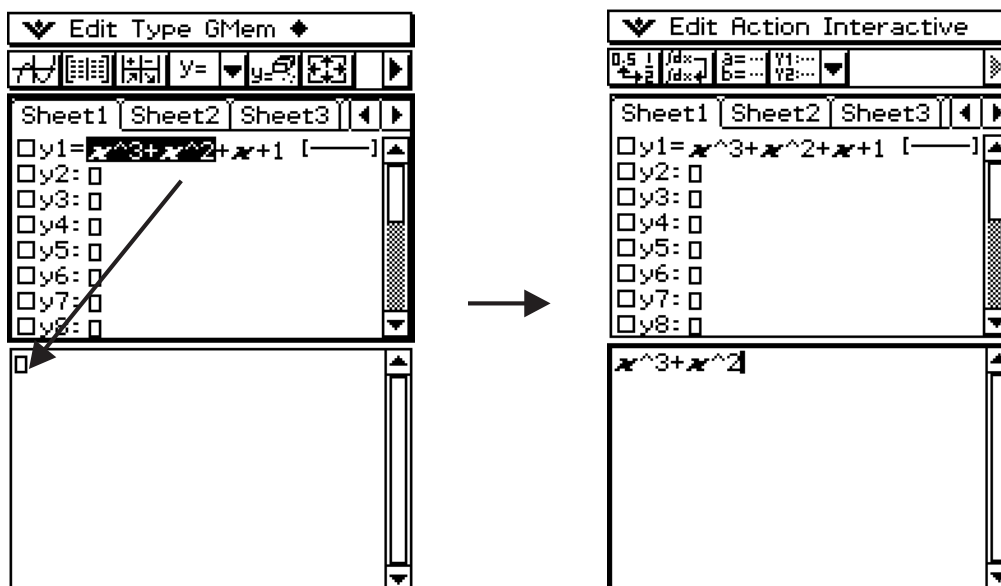

For full details about individual operations, see the chapters that cover each application.

Tip

- You cannot access the Main application window from the Geometry, Presentation, Spreadsheet, Financial, Communication, or System application.
- You can access the Geometry application from the Main application.

2-2 Basic Calculations

This section explains how to perform basic mathematical operations in the Main application.



Arithmetic Calculations and Parentheses Calculations

- You can perform arithmetic calculations by inputting expressions as they are written. All of the example calculations shown below are performed using the **mth** soft keyboard, unless noted otherwise.
- To input a negative value, tap **(-)** or **=** before entering the value.
- The order of operations is followed when a calculation consists of mixed arithmetic operations (multiplication and division are given priority over addition and subtraction).
- The example calculations are all performed using the Decimal mode. Using the Standard mode causes results to be displayed as fractions. For details about the Decimal mode and Standard mode, see “Status Bar Mode Indicators” on page 2-1-4.

Calculation	Key Operation
$23 + 4.5 - 53 = -25.5$	(2 3 + 4 . 5 - 5 3 EXE
$56 \times (-12) \div (-2.5) = 268.8$	(5 6 X ((-) 1 2) ÷ ((-) 2 . 5) EXE
$(2 + 3) \times 10^2 = 500$	(2 + 3) E 2 EXE
$1 + 2 - 3 \times 4 \div 5 + 6 = 6.6$	1 + 2 - 3 X 4 ÷ 5 + 6 EXE
$100 - (2 + 3) \times 4 = 80$	1 0 0 - (2 + 3) X 4 EXE
$2 + 3 \times (4 + 5) = 29$	2 + 3 X (4 + 5) EXE
$(7 - 2) \times (8 + 5) = 65$	(7 - 2) X (8 + 5) EXE
$\frac{6}{4 \times 5} = 0.3$	6 ÷ (4 X 5) EXE or 2D 6 ▼ 4 X 5 EXE
$(1 + 2i) + (2 + 3i) = 3 + 5i$	(1 + 2 i) + (2 + 3 i) EXE
$(2 + i) \times (2 - i) = 5$	(2 + i) X (2 - i) EXE

Tip

- For details about the calculations and result displays produced in each mode, see “Calculation Modes” on page 2-2-6.
- To toggle a result between decimal and fractional format, tap before pressing **EXE**.

Using the **EXP** Key

Use the **EXP** key to input exponential values. You can also input exponential values using the **E** key on the **mth** and **2D** keyboards.

Examples: $2.54 \times 10^3 = 2540$

2 **.** **5** **4** **EXP** **3** **EXE**

$1600 \times 10^{-4} = 0.16$

1 **6** **0** **0** **E** **-** **4** **EXE**

2.54E3	2540
1600E-4	0.16

Omitting the Multiplication Sign

You can omit the multiplication sign in any of the following cases.

- In front of a function
Examples: $2\sin(30)$, $10\log(1.2)$

- In front of a constant or variable
Examples: $a\pi$, $2ab$, $3ans$

- In front of an open parenthesis
Examples: $3(5 + 6)$, $(a + 1)(b - 1)$

Note that you must use a multiplication sign when the expression directly in front of the open parenthesis is a literal variable. Example: $ab(3 + b)$ must be written $ab \times (3 + b)$. Otherwise, your input is considered to be in function notation ($f(x)$).

- In front of the **EXP** key or **E** key (See "Using the **EXP** Key" above.)
- In front of a matrix or list

Examples: $a\{1, 2, 3\}$, $3[[1, 2][3, 4]]$

Using the Answer Variable (ans)

Any time you execute a calculation in the Main application work area, the last result is assigned automatically to a variable named "ans" (answer). You can even recall current "ans" variable contents and input them into another calculation by tapping the **ans** key as shown below.

Example: $123 + 456 = 579$

1 **2** **3** **+** **4** **5** **6** **EXE**

$789 - 579 = 210$

7 **8** **9** **-** **ans** **EXE**

$210 \div 7 = 30$

÷ **7** **EXE***

123+456	579
789-ans	210
ans/7	30

* Starting a calculation expression with +, -, ×, ÷, or ^ operator will cause the "ans" variable to be inserted automatically to the left of the operator, even if you do not tap the **ans** key. For more information, see "Performing Continuous Calculations" on page 2-2-3.

Tip

- The “ans” variable is a system variable. For details about system variables, see “1-7 Variables and Folders”.
- Since “ans” is a variable name, you can specify the “ans” variable by inputting [a][n][s] on the [abc] (alphabet) keyboard, or by tapping the [ans] key on the [mth] or the [2D] keyboard.
- The “ans” variable stores the result of your last or most recent calculation.
- The work area maintains a calculation history of the calculations you perform (page 2-3-1). Any instance of the “ans” variable in the calculation history contains the result of the calculation immediately prior to that instance. You can use “ans” as many times as you want in calculations, as long as you remember that the value or expression assigned to each “ans” variable in the calculation history is determined by the calculation immediately preceding it.
- Using the “ans” variable in a calculation results in an error if the previous calculation produced an error display or after a program produces the “done” message on the display.
- The format of the calculation result value assigned to the “ans” variable depends on the Basic Format dialog box [Number Format] setting (page 1-9-5). The following illustrates the format used when “Fix2” is selected for the [Number Format] setting.

approx (1/3) [EXE] 0.33

ans × 3 [EXE] 0.99

See “Standard Mode and Decimal Mode” on page 2-2-6.

■ Performing Continuous Calculations

Answer memory also lets you use the result of one calculation as one of the arguments in the next calculation.

Example: $1 \div 3 =$

$1 \div 3 \times 3 =$

[Clear] [1] [÷] [3] [EXE]
(Continuing) [X] [3] [EXE]

1/3	
	1/3
ans×3	1

Continuous calculations can be used with +, −, ×, ÷, and ^.



Assigning a Value to a Variable

Besides using the variable assignment key (\Rightarrow), page 1-7-6), you can also use the syntax shown below in the Main application and eActivity application to assign a value to a variable.

Syntax: Variable: = value

Example: Assign 123 to variable x

• ClassPad Operation

(1) Perform the key operation below in the Main application work area.

mth x abc \uparrow $:$ mth $=$ 1 2 3

(2) EXE

$x:=123$ 123

Important!

“:=” can be used only in Main and eActivity. It can NOT be used in a program. In the Program application, you must use \Rightarrow to store a value to a variable.

Calculation Error

An error message dialog box, like the one shown below, appears when there is a problem with the syntax of an input expression or value, when the number of decimal places of a calculation result in the Standard mode (page 2-2-6) exceeds a specified range, etc. Tap [OK] to close the dialog box and return to the calculation.



Tip

- The text of the error message dialog box depends on the type of error that occurred. For details, see the “Error Message Table” on page α -10-1.
- If you perform a calculation that is mathematically undefined (such as division by zero), the message “Undefined” appears in place of the calculation result, without display of an error message.

$2/0$ Undefined

Calculation Priority Sequence

Your ClassPad automatically performs calculations in the following sequence.

- ① Commands with parentheses (sin(, diff(, etc.)
- ② Factorials ($x!$), degree specifications ($^\circ$, $'$), percents (%)
- ③ Powers
- ④ π , memory, and variable multiplication operations that omit the multiplication sign (2π , $5A$, etc.)

Command with parentheses multiplication operations that omit the multiplication sign ($2\sqrt{3}$, etc.)

\times , \div

- ⑤ $+$, $-$, $(-)$
- ⑥ Relational operators ($=$, \neq , $<$, $>$, \leq , \geq)
- ⑦ and
- ⑧ or, xor
- ⑨ with (|)

Example: $2 + 3 \times (\log(\sin(2\pi^2)) + 6.8) = 22.07101691$ (In Algebra mode, Decimal mode, Radian mode.)

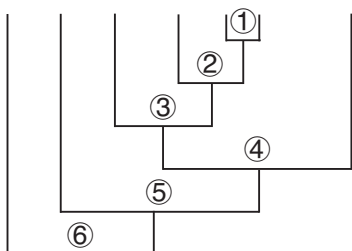

Tip

- Expressions in parentheses are given priority.
- In cases where a series of calculations in the same expression includes more than one of the operators ④ through ⑨ that are the same priority sequence level, the same level operations are performed from left to right. A series of power calculations ③ (example: 5^{2^3}) is performed from right to left ($5^{(2^3)}$).

Calculation Modes

The Main application has a number of different modes, as described under “Using Main Application Modes” on page 2-1-4. The display format of calculation results depends on the currently selected Main application mode. This section tells you which mode you need to use for each type of calculation, and explains the differences between the calculation results produced by each mode.

- All of the following calculation examples are shown using the Algebra mode only.

■ Standard Mode and Decimal Mode

The Standard mode displays calculation results in mathematical expression format whenever possible, while the decimal mode converts calculation results to a decimal form. When the Decimal mode is selected, you can control the use of exponential notation with the [Number Format] setting on the Basic Format dialog box (page 1-9-5).

• Examples of Decimal mode and Standard mode result displays

Expression	Decimal Mode Result	Standard Mode Result
$50 \div 4 = 12.5$	12.5	$\frac{25}{2}$
$100 \div 6 = 16.6666666\dots$	16.66666667	$\frac{50}{3}$
$\sqrt{2} + 2 = 3.414213562\dots$	3.414213562	$2 + \sqrt{2}$
$3.5^2 \div 3 + 2.5 = 6.583333333\dots$	6.583333333	$\frac{79}{12}$
$\pi = 3.1415926535\dots$	3.141592654	π
$\sin(2.1\pi) \times 5 = 1.5450849718\dots$	1.545084972	$\frac{5 \cdot (\sqrt{5} - 1)}{4}$

- The Decimal mode results in the above table show what would appear on the display when “Normal 1” is selected for the [Number Format] setting on the Basic Format dialog box.





• **Using the $\frac{D5}{\leftrightarrow 2}$ Button to Toggle between the Standard Mode and Decimal Mode**

You can tap $\frac{D5}{\leftrightarrow 2}$ to toggle a displayed value between Standard mode and Decimal mode format.

Note that tapping $\frac{D5}{\leftrightarrow 2}$ toggles the format of a displayed value. It does not change the current Standard mode/Decimal mode setting.

Example 1: Tapping $\frac{D5}{\leftrightarrow 2}$ while the ClassPad is configured for Standard mode (Normal 1) display

Expression	ClassPad Operation	Displayed Result
100 ÷ 6 = 16.6666666...	$\boxed{1} \boxed{0} \boxed{0} \boxed{\div} \boxed{6} \frac{D5}{\leftrightarrow 2}$ (Switches to Decimal mode format.)	16.66666667
	$\frac{D5}{\leftrightarrow 2}$ (Switches back to Standard mode format.)	$\frac{50}{3}$

Example 2: Tapping $\frac{D5}{\leftrightarrow 2}$ while the ClassPad is configured for Decimal mode (Normal 1) display

Expression	ClassPad Operation	Displayed Result
$\sqrt{2} + 2 = 3.414213562...$	$\checkmark \boxed{2} \boxed{)} \boxed{+} \boxed{2} \frac{D5}{\leftrightarrow 2}$ (Switches to Standard mode format.)	$2 + \sqrt{2}$
	$\frac{D5}{\leftrightarrow 2}$ (Switches back to Decimal mode format.)	3.414213562

• **Number of Decimal Places, Number of Significant Digits, Normal Display Settings**

The [Number Format] settings on the Basic Format dialog box (page 1-9-4) specify the number of decimal places, the number of significant digits, and the normal display setting for Main application Decimal mode calculation results. The following shows how calculation results appear under each setting.

Expression	Normal 1	Normal 2	Fix 3	Sci 3
50 ÷ 4 = 12.5	12.5	12.5	12.500	1.25E + 1
100 ÷ 6 = 16.6666666...	16.66666667	16.66666667	16.667	1.67E + 1
1 ÷ 600 = 0.00166666...	1.666666667E-3	0.001666666666	0.002	1.67E - 3
10 ¹¹ ÷ 4 = 2.5E + 10	2.5E + 10	2.5E + 10	2.5E + 10	2.50E + 10

- The allowable range for the number of decimal places is Fix 0 to Fix 9, and the range for the number of significant digits is Sci 0 to Sci 9. For details about the [Number Format] settings, see “Basic Format Dialog Box” on page 1-9-4.

■ **Complex Mode and Real Mode**

The Complex mode is for complex number calculations, while the Real mode is limited to calculations within the range of real numbers. Performing a calculation in the Real mode that produces a result that is outside the range of real numbers causes an error (Non-Real in Calc).

• **Examples of Complex mode and Real mode calculation results**

Expression	Complex Mode	Real Mode
solve ($x^3 - x^2 + x - 1 = 0, x$)	$\{x = -i, x = i, x = 1\}$	$\{x = 1\}$
$i + 2i$	$3 \cdot i$	ERROR: Non-Real in Calc

Tip

- You can select “*i*” or “*j*” for the imaginary unit. See “Specifying the Complex Number Imaginary Unit” on page 16-15-1.

■ **Radian Mode, Degree Mode and Grad Mode**

You can specify radians, degrees or grads as the angle unit for display of trigonometric calculation results.

• **Examples of Radian mode, Degree mode and Grad mode calculation results**

Expression	Radian Mode	Degree Mode	Grad Mode
$\sin(\pi/4)$	$\frac{\sqrt{2}}{2}$	$\sin\left(\frac{\pi}{4}\right)$	$\sin\left(\frac{\pi}{4}\right)$
$\sin(45)$	$\sin(45)$	$\frac{\sqrt{2}}{2}$	$\sin(45)$
$\sin(50)$	$\sin(50)$	$\sin(50)$	$\frac{\sqrt{2}}{2}$

Important!

Regardless of the currently selected angle unit setting, a calculation that includes an imaginary number power exponent (such as: $e^{\pi i}$) is performed using radians as the angle unit ($e^{\pi i} = -1$).

■ **Assistant Mode and Algebra Mode**

The Algebra mode automatically simplifies mathematical expressions produced by calculations. No simplification is performed in the Assistant mode. In the Assistant mode, you can view intermediate results as well, which allows you to see the steps that lead to a particular result as shown in the “expand” example below.

• **Examples of Assistant mode and Algebra mode calculation results**

Expression	Assistant Mode	Algebra Mode
$x^2 + 2x + 3x + 6$	$x^2 + 2 \cdot x + 3 \cdot x + 6$	$x^2 + 5 \cdot x + 6$
expand $((x+1)^2)$	$x^2 + 2 \cdot x \cdot 1 + 1^2$	$x^2 + 2 \cdot x + 1$
$x + 1$ (When 1 is assigned to x)	$x + 1$	2

Important!

The Assistant mode is available in the Main application and eActivity application only.

2-3 Using the Calculation History

The Main application work area calculation history can contain up to 30 expression/result pairs. You can look up a previous calculation, edit, and then re-calculate it, if you want.

Viewing Calculation History Contents

Use the scroll bar or scroll buttons to scroll the work area window up and down. This brings current calculation history contents into view.

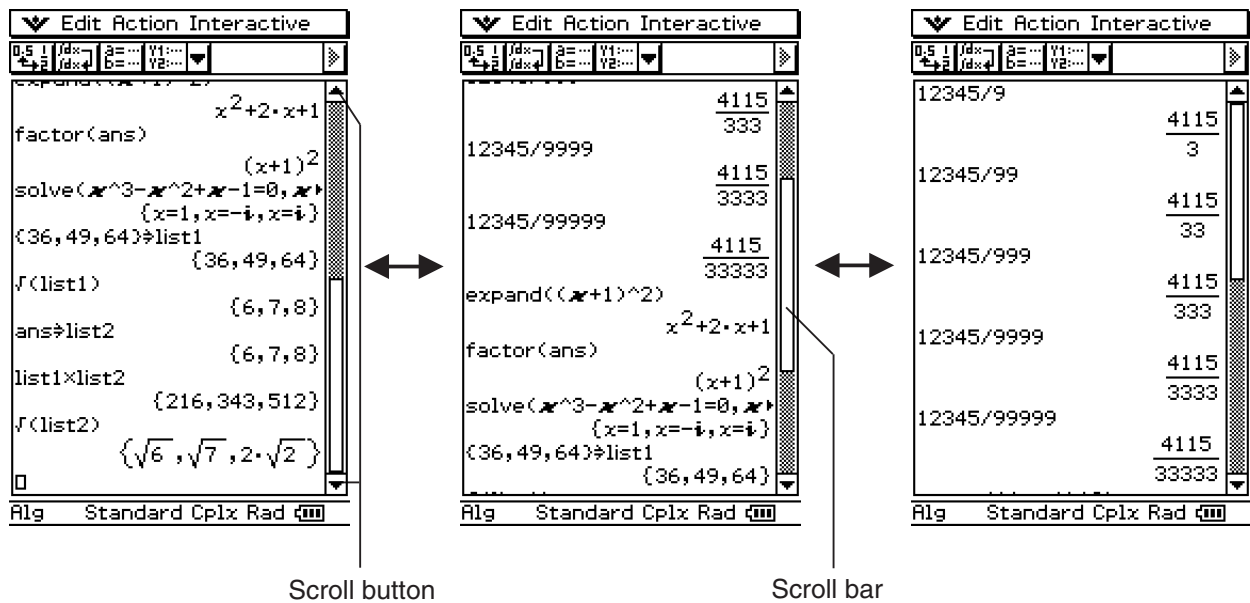

You can use the cursor keys to move to an input expression/calculation result within the calculation history window.

Tip

- After the number of expression/result pairs reaches 30, performing a new calculation causes the oldest calculation currently in the calculation history memory to be deleted.

Re-calculating an Expression

You can edit a calculation expression in the calculation history and then re-calculate the resulting expression. Tapping **EXE** re-calculates the expression where the cursor is currently located, and also re-calculates all of the expressions below the current cursor location.

Example 1: To change the expression “ans \times 2” to “ans \times 3” in the example below, and then re-calculate

• ClassPad Operation

(1) Tap to the right of the expression “ans \times 2” to locate the cursor there.

(2) Delete “2” and input “3”.



(3) Tap **EXE**.

- This re-calculates the expression where the cursor is located, and all the expressions underneath it.

7+5	
ans \times 2	12
ans+6	24
ans+6	30
□	

7+5	
ans \times 3	12
ans+6	36
ans+6	42
□	

Re-calculated

Important!

Remember that re-calculation is performed starting from the current cursor location. If, after performing the first two steps of the above procedure, you move the cursor to the end of “ans + 6” in line 3 of the calculation history and then tap **EXE**, only line 3 is re-calculated.

7+5	
ans \times 3	12
ans+6	24
ans+6	30
□	

Not re-calculated
(because it is above the
cursor location)

Re-calculated

If you edit multiple expressions in the calculation history, always make sure that the cursor is located in the uppermost line that you edited before you tap **EXE**.

Example 2: To change from the Standard mode to the Decimal mode (page 2-2-6), and then re-calculate

• ClassPad Operation

- (1) Move the cursor to the location from which you want to re-calculate.
 - In this example, we will tap the end of line 2 to locate the cursor there.
- (2) Tap “Standard” on the status bar to toggle it to “Decimal”.
- (3) Tap $\boxed{\text{EXE}}$.
 - This recalculates all of the expressions starting from the cursor position, and displays the results using Decimal mode format.

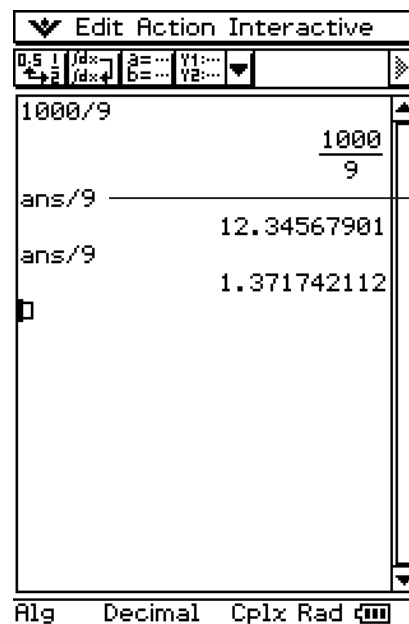
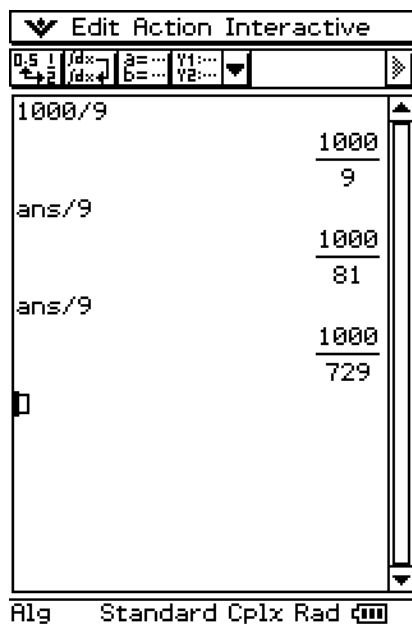

Tip

- You can also change to Decimal mode by tapping $\boxed{\text{Settings}}$ on the icon panel and then tapping [Basic Format]. Select the “Decimal Calculation” check box and then tap [Set].
- To re-calculate only a single specific line, tap $\boxed{\text{Re-Calc}}$. Tapping $\boxed{\text{Re-Calc}}$ re-calculates the calculation where the cursor is currently located only. It does not affect anything in calculation history that comes before or after the line.
- To re-calculate all of the expressions in the calculation history, locate the cursor in the top line, and then tap $\boxed{\text{EXE}}$.



Deleting Part of the Calculation History Contents

You can use the following procedure to delete an individual two-line expression/result unit from the calculation history.

• ClassPad Operation

- (1) Move the cursor to the expression line or result line of the two-line unit you want to delete.
- (2) Tap [Edit] and then [Delete].
 - This deletes the expression and result of the two-line unit you selected.

Important!

Even if the result of the deleted two-line unit has an effect on subsequent calculations, the affected calculations are not updated automatically following the deletion. When you want to update everything in the calculation history following the deleted unit, move the cursor to a line that is above the one you deleted and then tap **EXE**. For details about re-calculation, see page 2-3-2.

Clearing All Calculation History Contents

Perform the following procedure when you want to clear the entire calculation history currently in the Main application work area.

• ClassPad Operation

- (1) Tap [Edit] and then [Clear All].
- (2) In response to the confirmation message that appears, tap [OK] to clear calculation history contents, or [Cancel] to cancel.

2-4 Function Calculations

This section explains how to perform function calculations in the Main application work area.

- Most of the operators and functions described in this section are input from the **[mth]** (math) and **[cat]** (catalog) keyboard. The actual keyboard you should use to perform the sample operations presented here is the one indicated by a \bigcirc mark or by button names* (“TRIG”, “MATH”, “Cmd”, etc.) in one of the columns titled “Use this keyboard”.

* For more information about these buttons, see “Advanced Soft Keyboard Operations” (page 1-6-8).

- You do not need to input the closing parenthesis that comes immediately before an **[EXE]** key operation. All of the calculation examples in this section omit the closing parentheses before **[EXE]**.

The following example calculations are all performed using the Decimal mode. Using the Standard mode causes results to be displayed as fractions. For details about the Decimal mode and Standard mode, see “Status Bar Mode Indicators” on page 2-1-4.

■ Angle Conversion ($^{\circ}$, r)

The first two examples below use “Degree” (indicated by “Deg” in the status bar) as the angle unit setting. The final example uses “Radian” (indicated by “Rad” in the status bar) as the angle unit setting. Note that using the wrong angle unit setting will make it impossible to produce correct calculation results.

• To change the angle unit setting

(1) On the \blacktriangledown menu, tap [Basic Format].

(2) Tap the [Angle] down arrow button, and then select [Radian], [Degree] or [Grad].

For more information about this operation, see “1-9 Configuring Application Format Settings”.

Problem	Use this keyboard:				Operation
	mth	abc	cat	2D	
Convert 4.25 radians to degrees. = 243.5070629	TRIG	MATH	Cmd		4.25 [r] [EXE]
$47.3^{\circ} + 82.5\text{rad} = 4774.20181^{\circ}$	TRIG	MATH	Cmd		47.3 [+] 82.5 [r] [EXE]
How many radians is 243.5070629° ? = 4.249999999	TRIG	MATH	Cmd		Change the [Angle] setting to “Radian”, and then input 243.5070629 [r] [EXE] .

Tip

- You can also change the angle unit setting by tapping the current setting (Rad, Deg, or Gra) on the status bar. Each tap will cycle through the available settings.



■ Trigonometric Functions (sin, cos, tan) and Inverse Trigonometric Functions (sin⁻¹, cos⁻¹, tan⁻¹)

The first four examples below use “Degree” (indicated by “Deg” in the status bar) as the angle unit setting. The final example uses “Radian” (indicated by “Rad”). For details about these settings, see “1-9 Configuring Application Format Settings”.

Problem	Use this keyboard:				Operation
	mth	abc	cat	2D	
$\sin 63^\circ = 0.8910065242$	TRIG		Func		$\boxed{\sin} \boxed{63} \boxed{\text{EXE}}$
$2 \cdot \sin 45^\circ \times \cos 65^\circ$ $= 0.5976724775$	TRIG		Func		$\boxed{2} \boxed{\times} \boxed{\sin} \boxed{45} \boxed{)} \boxed{\times} \boxed{\cos} \boxed{65} \boxed{\text{EXE}}$ Can be omitted.
$\operatorname{cosec} 30^\circ = \frac{1}{\sin 30^\circ} = 2$	TRIG		Func		$\boxed{1} \boxed{\div} \boxed{\sin} \boxed{30} \boxed{\text{EXE}}$ or $\boxed{2D} \boxed{\frac{1}{\square}} \boxed{1} \boxed{\nabla}$ $\boxed{\text{mth}} \boxed{\sin} \boxed{30} \boxed{\text{EXE}}$
$\sin^{-1} 0.5 = 30^\circ$ (Determine x for $\sin x = 0.5$.)	TRIG		Func		$\boxed{\sin^{-1}} \boxed{0.5} \boxed{\text{EXE}}$ “.5” can also be used.
$\cos\left(\frac{\pi}{3}\right) \text{ rad} = 0.5$	TRIG		Func		Change the [Angle] setting to “Radian”. $\boxed{\cos} \boxed{\pi} \boxed{\div} \boxed{3} \boxed{\text{EXE}}$ or $\boxed{\cos} \boxed{2D} \boxed{\frac{\pi}{\square}} \boxed{\nabla} \boxed{3} \boxed{\text{EXE}}$

Tip

- The angle unit setting you specify remains in effect until you change it.
- To move between entry boxes in a 2D math symbol you can use the cursor keys or tap inside a box.

■ Logarithmic Functions (log, ln) and Exponential Functions (e , \wedge , $\sqrt{\quad}$)

Problem	Use this keyboard:				Operation
	mth	abc	cat	2D	
$\log 1.23$ ($\log_{10} 1.23$) = 0.08990511144	<input type="radio"/>		Func	<input type="radio"/>	$\boxed{\log} \ 1.23 \ \boxed{\text{EXE}}$ or $\boxed{2D} \ \boxed{\log_{10}} \ 10 \ \boxed{\text{▶}} \ 1.23 \ \boxed{\text{EXE}}$
$\ln 90$ ($\log_e 90$) = 4.49980967	<input type="radio"/>		Func	<input type="radio"/>	$\boxed{\ln} \ 90 \ \boxed{\text{EXE}}$ or $\boxed{2D} \ \boxed{\log_{10}} \ \boxed{\text{abc}} \ \boxed{\text{MATH}} \ \boxed{e}$ $\boxed{\text{▶}} \ 90 \ \boxed{\text{EXE}}$
$\log_3 9 = 2$	<input type="radio"/>		Func	<input type="radio"/>	$\boxed{\log} \ 3 \ \boxed{\text{,}} \ 9 \ \boxed{\text{EXE}}$ or $\boxed{2D} \ \boxed{\log_{10}} \ 3 \ \boxed{\text{▶}} \ 9 \ \boxed{\text{EXE}}$
$10^{1.23} = 16.98243652$	<input type="radio"/>	MATH	Cmd	<input type="radio"/>	$10 \ \boxed{\wedge} \ 1.23 \ \boxed{\text{EXE}}$
$e^{4.5} = 90.0171313$	<input type="radio"/>	MATH	Func	<input type="radio"/>	$\boxed{e^x} \ 4.5 \ \boxed{\text{EXE}}$ or $\boxed{2D} \ \boxed{e^x} \ 4.5 \ \boxed{\text{EXE}}$
$(-3)^4 = (-3) \times (-3) \times (-3) \times (-3) = 81$	<input type="radio"/>	MATH	Cmd	<input type="radio"/>	$\boxed{(-)} \ 3 \ \boxed{)} \ \boxed{\wedge} \ 4 \ \boxed{\text{EXE}}$
$-3^4 = -(3 \times 3 \times 3 \times 3) = -81$	<input type="radio"/>	MATH	Cmd	<input type="radio"/>	$\boxed{(-)} \ 3 \ \boxed{\wedge} \ 4 \ \boxed{\text{EXE}}$
$\sqrt[7]{123}$ ($= 123^{\frac{1}{7}}$) = 1.988647795	<input type="radio"/>	MATH	Cmd	<input type="radio"/>	$123 \ \boxed{\wedge} \ \boxed{(\text{)} \ 1 \ \boxed{\div}} \ 7 \ \boxed{\text{EXE}}$ or $\boxed{2D} \ \boxed{\sqrt{\quad}} \ 7 \ \boxed{\text{▶}} \ 123 \ \boxed{\text{EXE}}$
$2 + 3 \times \sqrt[3]{64} - 4 = 10$	<input type="radio"/>	MATH	Cmd	<input type="radio"/>	$2 \ \boxed{+} \ 3 \ \boxed{\times} \ 64 \ \boxed{\wedge} \ \boxed{(\text{)} \ 1 \ \boxed{\div}} \ 3 \ \boxed{)} \ \boxed{-} \ 4 \ \boxed{\text{EXE}}$ or $\boxed{2D} \ 2 \ \boxed{+} \ 3 \ \boxed{\times} \ \boxed{\sqrt{\quad}} \ 3 \ \boxed{\text{▶}} \ 64 \ \boxed{\text{▶}} \ \boxed{-} \ 4 \ \boxed{\text{EXE}}$ Can be omitted.

Tip

- \wedge and $\sqrt{\quad}$ have a higher calculation priority sequence than \times and \div .

■ Hyperbolic Functions (sinh, cosh, tanh) and Inverse Hyperbolic Functions (sinh⁻¹, cosh⁻¹, tanh⁻¹)

Problem	Use this keyboard:				Operation
	mth	abc	cat	2D	
$\sinh 3.6 = 18.28545536$	TRIG		Func		hyp sinh 3.6 EXE
$\cosh 1.5 - \sinh 1.5$ $= 0.2231301601$	TRIG		Func		hyp cosh 1.5) = hyp sinh 1.5 EXE
$e^{-1.5} = 0.2231301601^*$	○	MATH	Func	○	e^x (-) 1.5 EXE
$\cosh^{-1} \left(\frac{20}{15} \right)$ $= 0.7953654612$	TRIG		Func		hyp cosh⁻¹ 20 ÷ 15 EXE or hyp cosh⁻¹ 2D ▢ 20 ▼ 15 EXE
Solve for x given $\tanh(4x) = 0.88$. $x = \frac{\tanh^{-1} 0.88}{4}$ $= 0.3439419141$	TRIG		Func		hyp tanh⁻¹ 0.88) ÷ 4 EXE or 2D ▢ mth hyp tanh⁻¹ 0.88) ▼ 4 EXE

* This problem checks whether $\cosh x \pm \sinh x = e^{\pm x}$. Solving the problem above this one ($\cosh 1.5 - \sinh 1.5$) and comparing it with this problem's solution shows that they are equal.

■ Other Functions (% , $\sqrt{\quad}$, x^2 , x^{-1} , $x!$, abs, signum, int, frac, intg, fRound, sRound)

Problem	Use this keyboard:				Operation
	mth	abc	cat	2D	
What is 12% of 1500? 180		SMBL	Cmd		1500 \times 12 % EXE
What percent of 880 is 660? 75%		SMBL	Cmd		660 \div 880 % EXE
What value is 15% greater than 2500? 2875		SMBL	Cmd		2500 \times (1 + 15 %
What value is 25% less than 3500? 2625		SMBL	Cmd		3500 \times (1 - 25 %
$\sqrt{2} + \sqrt{5} = 3.65028154$	○		Func	○	$\sqrt{\quad}$ 2) + $\sqrt{\quad}$ 5 EXE or $\sqrt{\quad}$ 2) + $\sqrt{\quad}$ 5 EXE
$\sqrt{(3 + i)} = 1.755317302$ $+ 0.2848487846i$	○		Func	○	Change to the Complex mode ("Cplx" indicated on the status bar). $\sqrt{\quad}$ 3 + i EXE or $\sqrt{\quad}$ 3 + i EXE
$(-3)^2 = (-3) \times (-3) = 9$	○		Cmd		((- 3) x^2 EXE
$-3^2 = -(3 \times 3) = -9$	○		Cmd		(- 3 x^2 EXE
$\frac{1}{\frac{1}{3} - \frac{1}{4}} = 12$	○		Cmd	○	(3 x^{-1} - 4 x^{-1}) x^{-1} EXE or $\frac{\square}{\square}$ 1 ∇ $\frac{\square}{\square}$ 1 ∇ 3 ∇ - $\frac{\square}{\square}$ 1 ∇ 4 EXE
8! (= $1 \times 2 \times 3 \times \dots \times 8$) = 40320	CALC	SMBL	Cmd		8 ! EXE
What is the absolute value of the common logarithm of $\frac{3}{4}$? $ \log(\frac{3}{4}) = 0.1249387366$	○		Func	○	[x] log 3 \div 4 EXE or $\frac{\square}{\square}$ log $\frac{\square}{\square}$ 10 ∇ $\frac{\square}{\square}$ 3 ∇ 4 EXE



Problem	Use this keyboard:				Operation
	mth	abc	cat	2D	
What is the sign of -3.4567? -1 (signum returns -1 for a negative value, 1 for a positive value, "Undefined" for 0, and $\frac{A}{ A }$ for an imaginary number.)			Func		[signum] (←) 3.4567 (EXE)
What is the integer part of -3.4567? -3	CALC		Func		[int] (←) 3.4567 (EXE)
What is the decimal part of -3.4567? -0.4567			Func		[frac] (←) 3.4567 (EXE)
What is the greatest integer less than or equal to -3.4567? -4			Func		[intg] (←) 3.4567 (EXE)
What is -3.4567 rounded to two decimal places? -3.46			Func		[fRound] (←) 3.4567 (, 2 (EXE)
What is -34567 rounded to four significant digits? -34570			Func		[sRound] (←) 34567 (, 4 (EXE) *

* To round to 10 digits, specify "0" for the second argument.

■ Random Number Generator (rand, randList, randNorm, randBin, RandSeed)

- The ClassPad random number generator can generate truly random numbers (non-sequential random numbers) and random numbers that follow a particular pattern (sequential random numbers). Using the "randList" function, you can generate a list whose elements contain random numbers. There are nine different patterns for generation of sequential random numbers. Use the "RandSeed" command to switch between non-sequential and sequential random number generation, and to select the sequential random number generation pattern.

● ClassPad Operation

- (1) Use the "RandSeed" command to configure random number generation settings, if required.
- (2) Use the "rand", "randList", "randNorm", or "randBin" function to generate the random numbers.

• “rand” Function

- The “rand” function generates random numbers. If you do not specify an argument, “rand” generates 10-digit decimal values 0 or greater and less than 1.
Specifying two integer values for the argument generates random numbers between them.

Problem	Use this keyboard:				Operation
	mth	abc	cat	2D	
Generate random numbers between 0 and 1.			Func		[rand] EXE
Generate random integers between 1 and 6.			Func		[rand] 1 ▾ 6 EXE

• “randList” Function

Syntax: randList(n [, a, b])

Function:

- Omitting arguments “a” and “b” returns a list of n elements that contain decimal random values.
- Specifying arguments “a” and “b” returns a list of n elements that contain integer random values in the range of “a” through “b”.

Description:

- “ n ” must be a positive integer.
- The random numbers of each element are generated in accordance with “RandSeed” specifications, as with the “rand” function.

Problem	Use this keyboard:				Operation
	mth	abc	cat	2D	
Generate a list of three elements that contain decimal random values.			Func		[randList] 3 EXE
Generate a list of five elements that contain random values in the range of 1 through 6.			Func		[randList] 5 ▾ 1 ▾ 6 EXE

• “randNorm” Function

The “randNorm” function generates a 10-digit normal random number based on a specified mean σ and standard deviation μ values.

Syntax: randNorm(σ , μ [, n])

Function:

- Omitting a value for “ n ” (or specifying 1 for “ n ”) returns the generated random number as-is.
- Specifying a value for “ n ” returns the specified number of random values in list format.



Description:

- “ n ” must be a positive integer, and “ σ ” must be greater than 0.

Problem	Use this keyboard:				Operation
	mth	abc	cat	2D	
Randomly produce a body length value obtained in accordance with the normal distribution of a group of infants less than one year old with a mean body length of 68cm and standard deviation of 8.			Func		[randNorm] 8 $\left[\right]$ 68 $\left[\right]$ EXE
Randomly produce the body lengths of five infants in the above example, and display them in a list.			Func		[randNorm] 8 $\left[\right]$ 68 $\left[\right]$ 5 EXE

- **“randBin” Function**

The “randBin” function generates binomial random numbers based on values specified for the number of trials n and probability P .

Syntax: randBin(n , P [, m])

Function:

- Omitting a value for “ m ” (or specifying 1 for “ m ”) returns the generated random number as-is.
- Specifying a value for “ m ” returns the specified number of random values in list format.

Description:

- “ n ” and “ m ” must be positive integers.

Problem	Use this keyboard:				Operation
	mth	abc	cat	2D	
Randomly produce the number of heads that can be expected in accordance with binomial distribution for five coin tosses where the probability of heads is 0.5.			Func		[randBin] 5 $\left[\right]$ 0.5 $\left[\right]$ EXE
Perform the same coin toss sequence described above three times and display the results in a list.			Func		[randBin] 5 $\left[\right]$ 0.5 $\left[\right]$ 3 $\left[\right]$ EXE



• “RandSeed” Command

- You can specify an integer from 0 to 9 for the argument of this command. 0 specifies non-sequential random number generation. An integer from 1 to 9 uses the specified value as a seed for specification of sequential random numbers. The initial default argument for this command is 0.
- The numbers generated by the ClassPad immediately after you specify sequential random number generation always follow the same random pattern.

Problem	Use this keyboard:				Operation
	mth	abc	cat	2D	
Generate sequential random numbers using 3 as the seed value.			Cmd		[RandSeed] 3
Generate the first value. Generate the second value. Generate the third value.			Func		[rand] [rand] [rand]

Tip

- Random values generated by these commands are pseudo random values.
- The arguments a and b of “rand(a,b)” and “randList(n,a,b)” must be integers, subject to the following conditions.

$$a < b$$

$$|a|, |b| < 1E10$$

$$b - a < 1E10$$

■ Integer Functions

These functions take integers only as their arguments and return integers.

• “iGcd” Function

Syntax: iGcd(Exp-1, Exp-2[, Exp-3...Exp-10])
(Exp-1 through Exp-10 all are integers.)
iGcd(List-1, List-2[, List-3...List-10])
(All elements of List-1 through List-10 are integers.)

Function:

- The first syntax above returns the greatest common divisor for two to ten integers.
- The second syntax returns, in list format, the greatest common divisor (GCD) for each of the elements in two to ten lists. When the arguments are $\{a,b\}$, $\{c,d\}$, for example, a list will be returned showing the GCD for a and c , and for b and d .

Description:

- All of the lists must have the same number of elements.
- When using the “iGcd(List-1, List-2[, List-3...List-10])” syntax, one (and only one) expression (Exp) can be include as an argument in place of a list.

Problem	Use this keyboard:				Operation
	mth	abc	cat	2D	
Determine the greatest common divisors of {4, 3}, {12, 6}, and {36, 9}.			Func		[iGcd] { 4 } 3 } , { 12 } 6 } , { 36 } 9 } EXE

• “iLcm” Function

Syntax: iLcm(Exp-1, Exp-2[, Exp-3...Exp-10])

(Exp-1 through Exp-10 all are integers.)

iLcm(List-1, List-2[, List-3...List-10])

(All elements of List-1 through List-10 are integers.)

Function:

- The first syntax above returns the least common multiple for two to ten integers.
- The second syntax returns, in list format, the least common multiple (LCM) for each of the elements in two to ten lists. When the arguments are $\{a,b\}$, $\{c,d\}$, for example, a list will be returned showing the LCM for a and c , and for b and d .

Description:

- All of the lists must have the same number of elements.
- When using the “iLcm(List-1, List-2[, List-3...List-10])” syntax, one (and only one) expression (Exp) can be include as an argument in place of a list.

Problem	Use this keyboard:				Operation
	mth	abc	cat	2D	
Determine the least common multiples of {4, 3}, {12, 6}, and {36, 9}.			Func		[iLcm] { 4 } 3 } , { 12 } 6 } , { 36 } 9 } EXE

• “iMod” Function

Syntax: iMod(Exp-1/List-1, Exp-2/List-2[])

Function:

- This function divides one or more integers by one or more other integers and returns the remainder(s).

Description:

- Exp-1 and Exp-2, and all of the elements of List-1 and List-2 must be integers.
- You can use Exp for one argument and List for the other argument (Exp, List or List, Exp) if you want.
- If both arguments are lists, both lists must have the same number of elements.

Problem	Use this keyboard:				Operation
	mth	abc	cat	2D	
Divide 21 by 6 and 7, and determine the remainder of both operations. (iMod(21, {6, 7}))			Func		[iMod] 21 [↵] { 6 [↵] 7 } [↵] [EXE]

■ Permutation (nPr) and Combination (nCr)

● Total Number of Permutations

$$nPr = \frac{n!}{(n-r)!}$$

● Total Number of Combinations

$$nCr = \frac{n!}{r!(n-r)!}$$

Problem	Use this keyboard:				Operation
	mth	abc	cat	2D	
How many different permutations are possible when you have 10 different objects and arrange them four at a time? ${}_{10}P_4 = 5040$	CALC		Func		[nPr] 10 [↵] 4 [EXE]
How many different combinations are possible when you have 10 different objects and remove four at a time? ${}_{10}C_4 = 210$	CALC		Func		[nCr] 10 [↵] 4 [EXE]

■ Condition Judgment (judge, piecewise)

● “judge” Function

The “judge” function returns TRUE when an expression is true, and FALSE when it is false.

Problem	Use this keyboard:				Operation
	mth	abc	cat	2D	
Is the following expression true or false? $1 = 1$ TRUE			Func		[judge] 1 \equiv 1 EXE
Is the following expression true or false? $1 < 0$ FALSE			Func		[judge] 1 \lt 0 EXE

● “piecewise” Function

The “piecewise” function returns one value when an expression is true, and another value when the expression is false.

The syntax of the “piecewise” function is shown below.

piecewise(<condition expression>, <return value when true>, <return value when false or indeterminate> [])

or

piecewise(<condition expression>, <return value when true>, <return value when false>, <return value when indeterminate> [])

Use the 2D keyboard (f_{10}) to input “piecewise” function according to the syntax shown below.

{ <return value when true>, <condition expression>
{ <return value when false or indeterminate>

or

{ <return value when condition 1 is true>, <condition 1 expression>
{ <return value when condition 2 is true>, <condition 2 expression>

Problem	Use this keyboard:				Operation
	mth	abc	cat	2D	
For the expression $0 \geq x$ ($x = \text{variable}$), return 1 when x is 0 or less, and 2 when x is greater than 0 or undefined.			Func	\bigcirc	[piecewise] 0 \geq x f_{10} 1 f_{10} 2 EXE or f_{10} 1 f_{10} 2 f_{10} 0 \geq x EXE
For the expression $1 \geq x$ ($x = \text{variable}$), return 1 when x is 1 or less, and 2 when x is greater than 1.				\bigcirc	f_{10} 1 f_{10} 2 f_{10} 1 \geq x f_{10} 1 \lt x EXE

■ Angle Symbol (\angle)

Use this symbol to specify the coordinate format required by an angle in a vector.

You can use this symbol for a vector only.

Problem	Use this keyboard:				Operation
	mth	abc	cat	2D	
Convert the polar coordinates $r = \sqrt{2}$, $\theta = \pi/4$ to rectangular coordinates. [1, 1]	OPTN		Func		Change the [Angle] setting to "Radian". [toRect] [] [✓] 2 [)] [,] [∠] [π] [÷] 4 [)] [] [EXE]

■ Derivative Symbol (')

A single derivative symbol indicates the first derivative of an equation in the format: <variable name>'.

Problem	Use this keyboard:				Operation
	mth	abc	cat	2D	
Solve the differential equation $y' = x$. {y = 0.5 · x ² + const (1)}	CALC	SMBL	Cmd		[dSolve] [y] ['] [=] [x] [,] [x] [,] [y] [EXE]

Important!

The "dSolve" function can solve differential equations up to three degrees, so a maximum of three derivative symbols (y''') can be used. Executing a "dSolve" calculation that has more than three derivative symbols will result in an Invalid Syntax error.

■ Primality Test (isPrime)

The "isPrime" function determines whether the number provided as the argument is prime (returns TRUE) or not (returns FALSE). The syntax of the "isPrime" function is shown below.

isPrime(Exp/List[])

- Exp or all of the elements of List must be integers.

Problem	Use this keyboard:				Operation
	mth	abc	cat	2D	
Determine whether the numbers 51 and 17 are prime. (isPrime({51, 17}))			Func		[isPrime] [{] 51 [,] 17 [}] [)] [EXE]

■ Equal Symbols and Unequal Symbols (=, ≠, <, >, ≤, ≥)

You can use these symbols to perform a number of different basic calculations.

Problem	Use this keyboard:				Operation
	mth	abc	cat	2D	
To add 3 to both sides of $x = 3.$ $x + 3 = 6$	○	MATH	Cmd		$\boxed{(\ } \boxed{x} \boxed{=} \boxed{3} \boxed{)} \boxed{+} \boxed{3} \boxed{\text{EXE}}$
Subtract 2 from both sides of $y \leq 5.$ $y - 2 \leq 3$	OPTN	MATH	Cmd		$\boxed{(\ } \boxed{y} \boxed{\leq} \boxed{5} \boxed{)} \boxed{-} \boxed{2} \boxed{\text{EXE}}$

Tip

- In the “Syntax” explanations of each command under “2-8 Using the Action Menu”, the following operators are indicated as “Eq/Ineq”: =, ≠, <, >, ≤, ≥. Whether or not the “Eq/Ineq” operators include the “≠” operator is specified for each command by a separate note.
- An expression that contains multiple equation or inequality operators cannot be input as a single expression. For output expressions, an expression can be output with multiple operators only in the case of inequality operators that are facing in the same direction (example: $-1 < x < 1$).

Example: solve($x^2 - 1 < 0, x$) $\boxed{\text{EXE}}$ $\{-1 < x < 1\}$

■ “with” Operator (|)

The “with” (|) operator temporarily assigns a value to a variable. You can use the “with” operator in the following cases.

- To assign the value specified on the right side of | to the variable on the left side of |
- To limit or restrict the range of a variable on the left side of | in accordance with conditions provided on the right side of |

The following is the syntax for the “with” (|) operator.







Exp/Eq/Ineq/List/Mat|Eq/Ineq/List/(and operator)

You can put plural conditions in a list or connected with the “and” operator on the right side.

“≠” can be used on the left side or the right side of |.

Problem	Use this keyboard:				Operation
	mth	abc	cat	2D	
Evaluate $x^2 + x + 1$ when $x = 3.$ 13	OPTN	SMBL	Cmd		$\boxed{x} \boxed{\wedge} \boxed{2} \boxed{+} \boxed{x} \boxed{+} \boxed{1} \boxed{ } \boxed{x} \boxed{=} \boxed{3} \boxed{\text{EXE}}$
For $x^2 - 1 = 0$, determine the value of x when $x > 0.$ $\{x = 1\}$	OPTN	SMBL	Cmd		$\boxed{[\text{solve}]} \boxed{x} \boxed{\wedge} \boxed{2} \boxed{-} \boxed{1} \boxed{=} \boxed{0} \boxed{,} \boxed{x} \boxed{)} \boxed{ } \boxed{x} \boxed{>} \boxed{0} \boxed{\text{EXE}}$
Determine the value of abs (x) when $x > 0.$ x	OPTN	SMBL	Cmd		$\boxed{ x } \boxed{x} \boxed{)} \boxed{ } \boxed{x} \boxed{>} \boxed{0} \boxed{\text{EXE}}$

■ Solutions Supported by ClassPad (TRUE, FALSE, Undefined, No Solution, ∞ , const, constn)

Solution	Description	Example
TRUE	Output when a solution is true.	judge (1 = 1) 
FALSE	Output when a solution is false.	judge (1 < 0) 
Undefined	Output when a solution is undefined.	1/0 
No Solution	Output when there is no solution.	solve (abs (x) = -1, x) 
∞	Infinity	lim (1/x ² , x, 0) 
const	Constant displayed as const(1) when any value that is a constant is included in the solution. In the case of multiple constants, they are indicated as const(1), const(2), and so on.	dSolve (y' = x, x, y)  {y = 0.5·x ² + const (1)}
constn	Constant displayed as constn(1) when the solution includes any integer value that is a constant. In the case of multiple constants, they are indicated as constn(1), constn(2), and so on.	Change the [Angle] setting to "Degree". solve (sin (x) = 0, x)  {x = 180·constn (1)}



■ Dirac Delta Function

“delta” is the Dirac Delta function. The delta function evaluates numerically as shown below.

$$\delta(x) = \begin{cases} 0, & x \neq 0 \\ \delta(x), & x = 0 \end{cases}$$

Non-numeric expressions passed to the delta function are left unevaluated. The integral of a linear delta function is a Heaviside function.

Syntax: delta(x)

x : variable or number

Examples:

delta(x)	$\delta(x)$
$\delta(-2)$	0
$\delta(3)$	0
$\delta(0)$	$\delta(0)$
$\int_{-\infty}^{\infty} \delta(x) dx$	1
$\frac{d}{dx}(\delta(x))$	$\delta^{(1)}(x)$
$\int \delta(x) dx$	$H(x)$

■ n^{th} Delta Function

The n^{th} -delta function is the n th differential of the delta function.

Syntax: delta(x, n)

x : variable or number

n : number of differentials

Examples:

delta($x, 3$)	$\delta^{(3)}(x)$
$\frac{d^3}{dx^3}(\delta(x))$	$\delta^{(3)}(x)$

■ Heaviside Unit Step Function

“heaviside” is the command for the Heaviside function, which evaluates only to numeric expressions as shown below.

$$H(x) = \begin{cases} 0, & x < 0 \\ \frac{1}{2}, & x = 0 \\ 1, & x > 0 \end{cases}$$

Any non-numeric expression passed to the Heaviside function will not be evaluated, and any numeric expression containing complex numbers will return undefined. The derivative of the Heaviside function is the Delta function.

Syntax: heaviside(x)

x : variable or number

Examples:

heaviside(x)	$H(x)$
$H(-1)$	0
$H(0)$	$\frac{1}{2}$
$H(1)$	1
$\frac{d}{dx}(H(x))$	$\delta(x)$



■ Gamma Function

The Gamma function is called “gamma” on the ClassPad.

$$\Gamma(x) = \int_0^{+\infty} t^{x-1} e^{-t} dt$$

For an integer n the gamma is evaluated as shown below.

$$\Gamma(n) = \begin{cases} (n-1)!, & n > 0 \\ \text{undefined}, & n \leq 0 \end{cases}$$

The gamma is defined for all real numbers excluding negative integers. It is also defined for all complex numbers where either the real or imaginary part of the complex number is not an integer.

Gamma of a symbolic expression returns unevaluated.

Syntax: gamma(x)

x : variable or number

Examples:

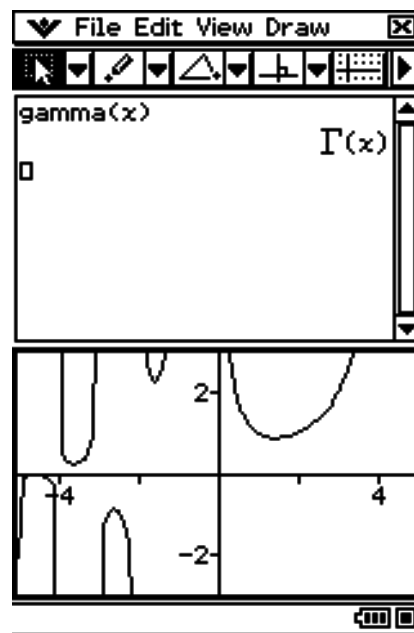
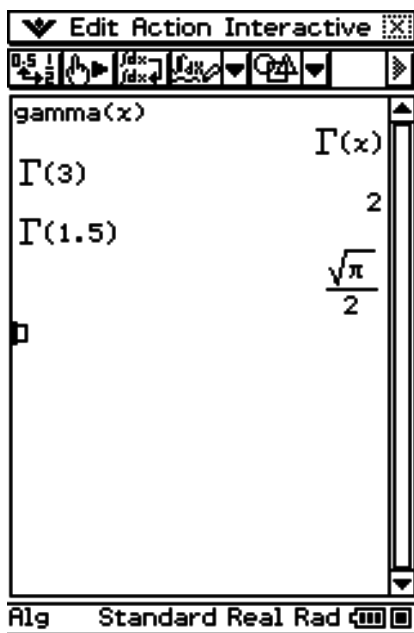

2-5 List Calculations

This section explains how to input data using the Main application or Stat Editor, and how to perform basic list calculations.



Inputting List Data

You can input list data from the work area or on the Stat Editor window.

■ Inputting List Data from the Work Area

Example: To input the list {1, 2, 3} and assign it to LIST variable "lista".

● ClassPad Operation

- (1) Tap  to display the application menu, and then tap  to start the Main application.
- (2) Press  to display the soft keyboard.
- (3) Next, perform the following key operation.



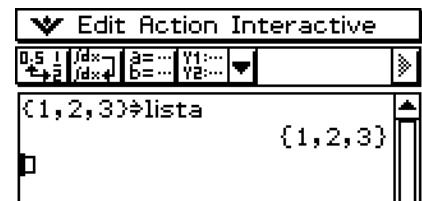

Tip

- For information about assigning data to a variable, see "Creating and Using Variables" on page 1-7-5.
- You can also create a list using commands in the [List-Create] group on the [Action] menu. For information about using these commands, see "2-8 Using the Action Menu".



■ LIST Variable Element Operations

You can recall the value of any element of a LIST variable. When the values {1, 2, 3} are assigned to “lista”, for example, you can recall the second value in the “lista”, when you need it.

You can also assign a value to any element in a list. When the values {1, 2, 3} are assigned to “lista”, for example, you can replace the second value with “5” to end up with {1, 5, 3}. After performing the procedure under “Inputting List Data from the Work Area”, perform the following operation.

● ClassPad Operation

(1) Recall the value of the second element of LIST variable “lista”.

`abc` `[]` `i` `s` `t` `a` `mth` `[]` `2` `[]` `EXE`

```
(1,2,3)⇒lista
                               (1,2,3)
lista[2]
                               2
```

(2) Assign “5” to the second element of LIST variable “lista”.

`5` `⇒` `abc` `[]` `i` `s` `t` `a` `mth` `[]` `2` `[]` `EXE`

```
(1,2,3)⇒lista
                               (1,2,3)
lista[2]
                               2
5⇒lista[2]
                               (1,5,3)
```

Tip

- You can also perform the above operations on the “ans” variable (page 2-2-2) when it contains LIST data.

Example: {1, 2, 3, 4} `EXE` {1, 2, 3, 4}

`ans` `[]` `2` `[]` `EXE` 2

■ Inputting List Data Using the Stat Editor Window

Tapping `☰` displays the Stat Editor window, which you can then use to input list data. List data input this way is assigned to a LIST variable, so you can access it by specifying the applicable variable name.

For more information about using the Stat Editor window to create a list, see “7-2 Using Stat Editor”.

Using a List in a Calculation

You can perform arithmetic operations between two lists, between a list and a numeric value, or between a list and an expression, equation, or inequality.

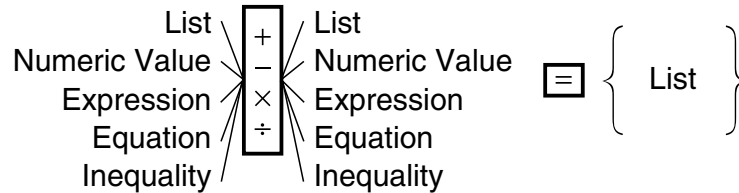

List Calculation Errors

- When you perform an arithmetic operation between two lists, both of the lists need to have the same number of cells. An error will occur if they do not.
- An error will also occur whenever an operation between any two cells of the two lists results in an error.

List Calculation Example

Example: Perform the operation $\text{list3} \times \{6, 0, 4\}$ when list3 contains $\{41, 65, 22\}$

ClassPad Operation

(1) Perform the key operation below in the Main application work area.

`abc` `|` `i` `s` `t` `3` `mth` `×` `{` `6` `,` `0` `,` `4` `}`

(2) `EXE`

```
{41,65,22}÷list3
      {41,65,22}
list3×{6,0,4}
      {246,0,88}
```

Tip

- List operations (extraction of list maximum and minimum, calculation of list total, etc.) can also be performed using the commands in the [List-Calculation] group of the [Action] menu. For more information, see “2-8 Using the Action Menu”.

Using a List to Assign Different Values to Multiple Variables

Use the procedure in this section when you want to use a list to assign various different values to multiple variables.

Syntax: List with Numbers \Rightarrow List with Variables

Example: Assign the values 10, 20, and 30, to variables x , y , and z respectively

• ClassPad Operation

(1) Perform the key operation below in the Main application work area.

`[mth] [{] [1] [0] [,] [2] [0] [,] [3] [0] [}] [\Rightarrow] [{] [x] [,] [y] [,] [z] [}]`

(2) `[EXE]`

`{10,20,30} \Rightarrow {x,y,z}`
`{10,20,30}`

Tip

- You can perform this operation using a matrix that has a single row and multiple columns, or multiple rows and a single column. For details see “Using a Matrix to Assign Different Values to Multiple Variables” on page 2-6-6.



2-6 Matrix and Vector Calculations

This section explains how to create matrices in the Main application, and how to perform basic matrix calculations.

Tip

- Since a vector can be viewed as 1-row by n -column matrix or n -row by 1-column matrix, this section does not include explanations specifically about vectors. For more information about vector-specific calculations, see the explanations about the applicable [Action] menu items in “2-8 Using the Action Menu”.

Inputting Matrix Data

You can use the **[mth]** (math) keyboard to input matrix values in a single line in the work area, or the **[2D]** keyboard to input matrix values using an actual on-screen matrix.

■ Inputting Matrix Values with the **[mth]** Keyboard

Example: To input the matrix $\begin{bmatrix} 1 & 2 \\ 3 & 4 \end{bmatrix}$ and assign it to the variable “mat1”

● ClassPad Operation

- (1) On the application menu, tap  to start the Main application.
- (2) Press **[Keyboard]** to display the soft keyboard.
- (3) Next, perform the following key operation.

[mth] **[]** **[]** **[1]** **[,]** **[2]** **[]** **[]** **[3]** **[,]** **[4]** **[]** **[]** **[⇒]**
[abc] **[m]** **[a]** **[t]** **[1]** **[EXE]**

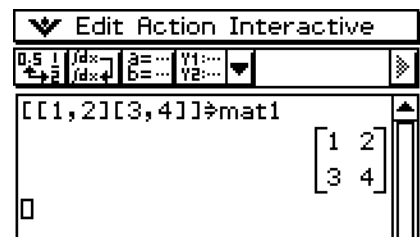

Tip

- For information about assigning data to a variable, see “Creating and Using Variables” on page 1-7-5.



Matrix Variable Element Operations

You can recall the value of any element of a MATRIX variable. When the data $\begin{bmatrix} 1 & 2 \\ 3 & 4 \end{bmatrix}$ is assigned to matrix “mat1”, for example, you can recall the element located at row 2, column 1.

You can also assign a value to any element in a matrix. For example, you could assign the value “5” to the element at row 1 column 2 in “mat1”, which produces the matrix $\begin{bmatrix} 1 & 5 \\ 3 & 4 \end{bmatrix}$.

After performing the procedure under “Inputting Matrix Values with the $\boxed{\text{mth}}$ Keyboard”, perform the following operation.

ClassPad Operation

(1) Recall the value in row 2, column 1 of MATRIX variable “mat1”.

$\boxed{\text{abc}} \boxed{\text{m}} \boxed{\text{a}} \boxed{\text{t}} \boxed{1} \boxed{\text{mth}} \boxed{[}$ $\boxed{2}$ $\boxed{,}$ $\boxed{1}$ $\boxed{]}$ $\boxed{\text{EXE}}$
↑ ↑
Row Column

```
[[1,2][3,4]]→mat1
mat1[2,1]
3
```

(2) Assign “5” to the element at row 1, column 2 of MATRIX variable “mat1”.

$\boxed{5} \Rightarrow \boxed{\text{abc}} \boxed{\text{m}} \boxed{\text{a}} \boxed{\text{t}} \boxed{1} \boxed{\text{mth}} \boxed{[}$ $\boxed{1}$ $\boxed{,}$ $\boxed{2}$ $\boxed{]}$ $\boxed{\text{EXE}}$

```
mat1[2,1]
5→mat1[1,2]
3
1 5
3 4
```



Tip







- You can also perform the above operations on the “ans” variable (page 2-2-2) when it contains MATRIX data.

Example: $\boxed{[}$ $\boxed{[}$ $\boxed{1}$ $\boxed{,}$ $\boxed{2}$ $\boxed{]}$ $\boxed{[}$ $\boxed{3}$ $\boxed{,}$ $\boxed{4}$ $\boxed{]}$ $\boxed{]}$ $\boxed{\text{EXE}}$ $\begin{bmatrix} 1 & 2 \\ 3 & 4 \end{bmatrix}$

$\boxed{\text{ans}} \boxed{[}$ $\boxed{2}$ $\boxed{,}$ $\boxed{1}$ $\boxed{]}$ $\boxed{\text{EXE}}$ 3

■ Inputting Matrix Values with the **2D** Keyboard

The , , and  keys of the **2D** keyboard make matrix value input quick and easy.

To do this:	Tap this 2D key:
Create a new 1-row × 2-column matrix	
Create a new 2-row × 1-column matrix	
Create a new 2-row × 2-column matrix	
Add a column to the currently displayed matrix	
Add a row to the currently displayed matrix	
Add both a row and column to the currently displayed matrix	

Example: To input the matrix $\begin{bmatrix} 1 & 2 & 3 \\ 4 & 5 & 6 \end{bmatrix}$ and assign it to the variable “mat2”

● ClassPad Operation

(1) Tap **2D** **CALC** to display the **CALC** keyset of the **2D** keyboard, and then perform the key operation below in the Main application work area.

 (Creates a 1-row × 2-column matrix.)

1  **2**

```
[ 1 2 ]
```

 (Adds one column to the matrix.)

3

```
[ 1 2 3 ]
```

 (Adds one row to the matrix.)

4  **5**  **6**





```
[ 1 2 3 ]
[ 4 5 6 ]
```

(2) Perform the key operation below to assign the matrix to the variable named “mat2”.

  **abc** **m** **a** **t** **2** **EXE**

```
[ 1 2 3 ] ⇒ mat2
[ 4 5 6 ]
[ 1 2 3 ]
[ 4 5 6 ]
```

Tip

- In step (1) of the above procedure, we added rows and columns as they became necessary. Another way to accomplish the same result would be to add rows and columns to create a blank matrix of the required dimensions, and then start data input. You could create a 2-row \times 3-column matrix by tapping , , , or , . In either case, you could also tap the buttons in reverse of the sequence shown here.
- You can also create matrices using the commands of the [Matrix-Create] group on the [Action] menu. For information about using these commands, see “2-8 Using the Action Menu”.

Performing Matrix Calculations

This section provides examples of how to perform the most basic types of matrix calculations.

Matrix Addition, Subtraction, Multiplication, and Division

Example 1: $\begin{bmatrix} 1 & 1 \\ 2 & 1 \end{bmatrix} + \begin{bmatrix} 2 & 3 \\ 2 & 1 \end{bmatrix}$

ClassPad Operation

(1) Perform the key operation below in the Main application work area.



            
          

(2) Tap .



$$\begin{bmatrix} [[1,1][2,1]]+[[2,3][2,1]] \\ [3\ 4] \\ [4\ 2] \end{bmatrix}$$

Example 2: $\begin{bmatrix} 1 & 1 \\ 2 & 1 \end{bmatrix} \times \begin{bmatrix} 2 & 3 \\ 2 & 1 \end{bmatrix}$

ClassPad Operation

(1) Tap , , , and then input the values for the first matrix.

$$\begin{bmatrix} 1 & 1 \\ 2 & 1 \end{bmatrix}$$

(2) Tap the area to the right of the input matrix or press the cursor  key to move the cursor to the right of the input matrix. Next, tap .

$$\begin{bmatrix} 1 & 1 \\ 2 & 1 \end{bmatrix} \times$$

(3) Tap , and then input the values for the second matrix.

$$\begin{bmatrix} 1 & 1 \\ 2 & 1 \end{bmatrix} \times \begin{bmatrix} 2 & 3 \\ 2 & 1 \end{bmatrix}$$

(4) Tap .

$$\begin{bmatrix} 1 & 1 \\ 2 & 1 \end{bmatrix} \times \begin{bmatrix} 2 & 3 \\ 2 & 1 \end{bmatrix} = \begin{bmatrix} 4 & 4 \\ 6 & 7 \end{bmatrix}$$

Example 3: To multiply the matrix $\begin{bmatrix} 1 & 2 \\ 3 & 4 \end{bmatrix}$ by 5

• ClassPad Operation

(1) Perform the key operation below in the Main application work area.

   1  2  3  4    5

(2) Tap .

$$[[1,2][3,4]] \times 5 = \begin{bmatrix} 5 & 10 \\ 15 & 20 \end{bmatrix}$$

Tip

- Note that when adding or subtracting two matrices, they both must have the same number of rows and the same number of columns (the same dimensions). An error occurs (Invalid Dimension Error) when the two matrices have different dimensions.
- When multiplying two matrices, the number of columns in the matrix to the left of the multiplication sign (\times) must be the same as the number of rows in the matrix to the right of the multiplication sign. An error occurs (Invalid Dimension Error) when you attempt to multiply two matrices that do not satisfy the above conditions.
- Multiplication is assumed if you do not include any operator between two matrices. $[[1, 2] [3, 4]] [[2, 2] [2, 2]]$ for example, is treated as $[[1, 2] [3, 4]] \times [[2, 2] [2, 2]]$.

■ Raising a Matrix to a Specific Power

Example: To raise $\begin{bmatrix} 1 & 2 \\ 3 & 4 \end{bmatrix}$ to the power of 3

Use the procedures described under “Matrix Addition, Subtraction, Multiplication, and Division” on page 2-6-4 to input the calculation.

The following are the screens that would be produced by each input method.

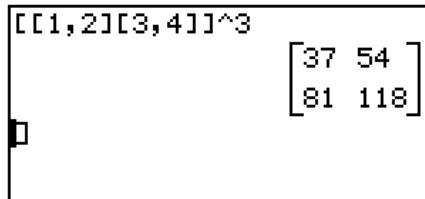

Input using the **mth** keyboard

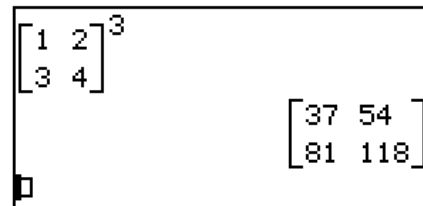

Input using the **2D** keyboard

Tip

- You can perform matrix calculations using the commands of the [Matrix-Calculation] group on the [Action] menu. For information about using these commands, see “2-8 Using the Action Menu”.
- You can raise only a square matrix to a specific power. An error occurs when you try to raise a non-square matrix to a specific power.

Using a Matrix to Assign Different Values to Multiple Variables

Use the procedure in this section when you want to use a matrix to assign various different values to multiple variables.

Syntax: Matrix with Numbers → Matrix with Variables

(The matrix can be one line with multiple columns, or multiple lines with one column.)

Example: Assign the values 10, 20, and 30, to variables x , y , and z respectively

• ClassPad Operation

(1) Perform the key operation below in the Main application work area.



(2) **EXE**

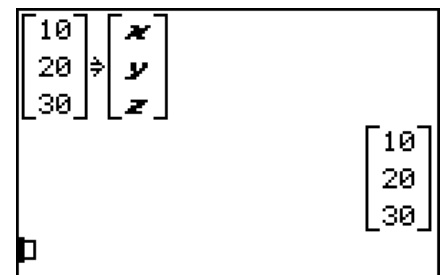

Tip

- You can also perform this operation using a list. For details see “Using a List to Assign Different Values to Multiple Variables” on page 2-5-4.

2-7 Specifying a Number Base



While using the Main application, you can specify a default number base (binary, octal, decimal, hexadecimal) or you can specify a number base for a particular integer value. You can also convert between number bases and perform bitwise operations using logical operators (not, and, or, xor). Note that while a default number base is specified, you can input integers only.

Number Base Precautions

Note the following limitations, which all apply while a default number base (binary, octal, decimal, hexadecimal) is specified in the Main application.

- You cannot use scientific functions, or [Action] or [Interactive] menu commands.
- Except for Ans (Answer Memory variable), you cannot use variables.
- You can input integers only. An error (Invalid syntax ERROR) will occur if you try to input a non-integer value (like 1.5 or $\sqrt{2}$).
- If a calculation produces a non-integer result (with a decimal part), the calculator will cut off the decimal part automatically. For example, the calculation $5 \div 2$ while decimal is selected as the number base is 2.
- A error message is displayed if you try to enter a value that is invalid for the specified number base. The following shows the numerals that can be used in each number system.

Binary: 0, 1

Octal: 0, 1, 2, 3, 4, 5, 6, 7

Decimal: 0, 1, 2, 3, 4, 5, 6, 7, 8, 9

Hexadecimal: 0, 1, 2, 3, 4, 5, 6, 7, 8, 9, A, B, C, D, E, F

Binary, Octal, Decimal, and Hexadecimal Calculation Ranges

- The following are the display capacities for each of the number bases.

Number Base	Display Capacity
Binary	32 digits
Octal	11 digits
Decimal	10 digits
Hexadecimal	8 digits

- Negative binary, octal, and hexadecimal values are produced using the two's complement of the original value.

- The following are the calculation ranges for each of the number bases.

Binary Values:

Positive: $0 \leq x \leq 01111111111111111111111111111111$

Negative: $10000000000000000000000000000000 \leq x \leq 11111111111111111111111111111111$

Octal Values:

Positive: $0 \leq x \leq 1777777777$

Negative: $2000000000 \leq x \leq 3777777777$

Decimal Values:

Positive: $0 \leq x \leq 2147483647$

Negative: $-2147483648 \leq x \leq -1$

Hexadecimal Values:

Positive: $0 \leq x \leq 7FFFFFFF$

Negative: $80000000 \leq x \leq FFFFFFFF$



Selecting a Number Base

Specifying a default number base in the Main application will apply to the current line (expression/result pair), and to all subsequent lines until you change the default number base setting. Use the number toolbar's base buttons to specify the number base.

• To select the number base for the line where the cursor is located

(1) Tap the down arrow button next to the  button.

- This displays a palette of number base buttons.

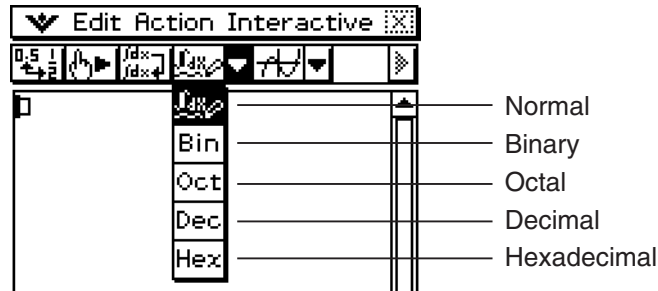

(2) Tap the button that corresponds to the number base you want to use.

- To select binary, for example, tap .
- The currently selected number base is indicated in the status bar.



(3) Execute the calculation.

- When you press  to execute the calculation, the number base you selected in step 2 is also applied automatically to the next line. You can continue using the same number base in the next line or change to another number base.

Important!

- A line for which a number base is not specified is called a “normal calculation line.” To return a line to a normal calculation line, tap  in step 2 of the above procedure.
- Calculation results produced by a line for which a number base is specified are followed by one of the suffixes listed below, to indicate its number system.

Number System	Suffix
Binary	b
Octal	o
Decimal	d
Hexadecimal	h

- Whenever you input a value into a line for which a number base is specified, the input value is converted automatically to the specified number base. Performing the calculation $19+1$ in a line for which Hex (Hexadecimal) is specified as the number base, both the 19 and 1 are interpreted as hexadecimal values, which produces the calculation result 1Ah. The “h” is the suffix indicating hexadecimal notation.

- **To specify a number base for an input value**

You can input the following suffixes to specify the number base of a value as you input it: [b] (binary), [o] (octal), [d] (decimal), and [h] (hexadecimal).

You can specify a number base for an input value only when a default number base (besides normal) is selected

Tip

- For actual operation examples, see Example 3 under “Arithmetic Operations” below.

Arithmetic Operations

You can use the following operators when performing binary, octal, decimal and hexadecimal values: +, −, ×, ÷, ^, %. You can also use parenthetical expressions.

Example 1: To calculate $10111_2 + 11010_2$

(1) Tap the down arrow button next to the  button, and then tap .

(2) Perform the following key operation.

 110001b

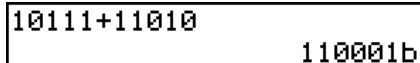
Example 2: To calculate $(11_8 + 7_8)^2$



(1) Tap the down arrow button next to the  button, and then tap .

(2) Perform the following key operation.

 400o

Example 3: Perform the calculation $123_{10} + 1010_2$ so it produces a hexadecimal result

(1) Tap the down arrow button next to the  button, and then tap .

(2) Perform the following key operation using the soft keyboard.

 85h

Bitwise Operations

The logical operators listed below can be used in calculations.

Operator	Description
and	Returns the result of a bitwise product.
or	Returns the result of a bitwise sum.
xor	Returns the result of a bitwise exclusive logical sum.
not	Returns the result of a complement (bitwise inversion).

Examples 1, 2, and 3 use Bin (binary) as the number system. Example 4 uses Hex (hexadecimal).

Example 1: 1010_2 and $1100_2 = 1000_2$

abc 1 0 1 0 SPACE a n d SPACE 1 1 0 0 EXE

```
1010 and 1100
                        1000b
```

Example 2: 1011_2 or $11010_2 = 11011_2$

abc 1 0 1 1 SPACE o r SPACE 1 1 0 1 0 EXE

```
1011 or 11010
                        11011b
```

Example 3: 1010_2 xor $1100_2 = 110_2$

abc 1 0 1 0 SPACE x o r SPACE 1 1 0 0 EXE

```
1010 xor 1100
                        110b
```

Example 4: not ($FFFF_{16}$) = $FFFF0000_{16}$

abc n o t (f f f f) EXE

```
not(ffff)
                        FFFF0000h
```

Using the baseConvert Function (Number System Transform)

The baseConvert function lets you convert a number in one base (number system) to its equivalent in another base.

Important!

- The baseConvert function works for positive integers only.
- The baseConvert function cannot be used in a line for which a particular number base is specified. It can be used in a normal calculation line only.

Syntax: baseConvert (Number, Current base, Expected base)

- Number must be a positive integer consisting of digits 0 to 9 and/or A to F.
- The current base and expected base can be any whole number from 2 to 16.

Examples:

```
baseConvert(579,15,12)
                        873
baseConvert(100,13,10)
                        169
baseConvert(123,16,3)
                        101210
```

2-8 Using the Action Menu

The [Action] menu helps to make transformation and expansion functions, calculus functions, statistical functions, and other frequently used mathematical menu operations easier to use. Simply select the function you want, and then enter expressions or variables in accordance with the syntax of the function.

Tip

- Unless specifically indicated otherwise, all of the explanations in this section are performed using the following modes: Algebra mode, Standard mode, Complex mode, Radian mode, Descending Order.
- You can use the [Interactive] menu to select most of the commands that are included on the [Action] menu. Selecting a command on the [Action] menu will simply input the function for that command. With the [Interactive] menu selecting a command will display a dialog box that prompts for input of the command's arguments (when necessary). This means that the [Interactive] menu eliminates the need to remember details about the syntax of a function. For details about using the [Interactive] menu, see page 2-9-1.

Abbreviations and Punctuation Used in This Section

The following are the meanings of the abbreviations and punctuation used in the syntax descriptions in this section.

When you see this:	It means this:
Exp	Expression (Value, Variable, etc.)
Eq	Equation
Ineq	Inequality
List	List
Mat	Matrix
[]	You can omit the item(s) inside the brackets.
{ }	Select one of the items inside the braces.

Some of the syntaxes in the following explanations indicate the following for parameters:
Exp/Eq/Ineq/List/Mat

These abbreviations mean that you can use any of the following as a parameter: expression, equation, inequality list, or matrix.





Example Screenshots

The screenshots below show examples of how input and output expressions appear on the ClassPad display.

In some cases, the input expression and output expression (result) may not fit in the display area. If this happens, tap the left or right arrows that appear on the display to scroll the expression screen and view the part that does not fit.

When the input expression does not fit:

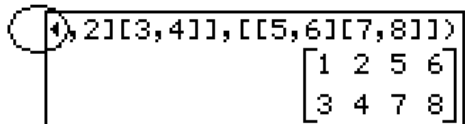
Displayed expression

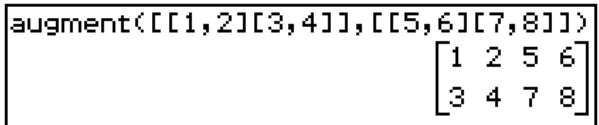
Complete expression

When the output expression does not fit:

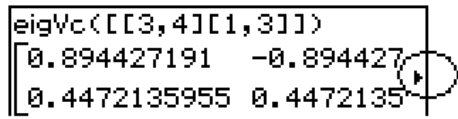

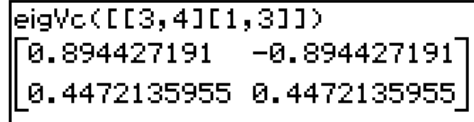
Displayed expression

Complete expression

All of the screenshots in this section show the “complete expression” version.

Displaying the Action Menu

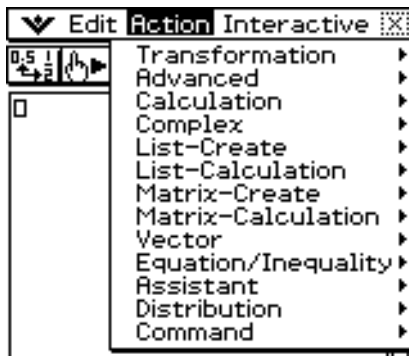
Tap [Action] on the menu bar to display the menu of 12 submenus shown below.



The following explains the functions that are available on each of these submenus.

Using the Transformation Submenu

The [Transformation] submenu contains commands for expression transformation, like “expand” and “factor”.

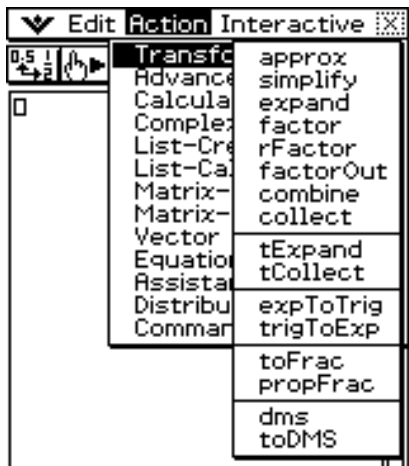

- **approx**

Function: Transforms an expression into a numerical approximation.

Syntax: `approx (Exp/Eq/Ineq/List/Mat [])`

- Ineq (inequality) includes the “≠” (not equal to) relational operator.

Example: To obtain the numerical value of $\sqrt{2}$

Menu Item: [Action][Transformation][approx]

```
approx(√(2))
1.414213562
```

(Number Format: Normal 1)

Example: To obtain the numerical value of 9^{20}

Menu Item: [Action][Transformation][approx]

```
approx(9^20)
1.215766546E+19
```

(Number Format: Normal 1)

- For information about the internal operations and the number of digits of a displayed value, see page 2-2-7.



• simplify

Function: Simplifies an expression.

Syntax: simplify (Exp/Eq/Ineq/List/Mat [])

- Ineq (inequality) includes the “≠” (not equal to) relational operator.

Example: To simplify $(15\sqrt{3} + 26)^{1/3}$

Menu Item: [Action][Transformation][simplify]

$$\text{simplify}((15\sqrt{3} + 26)^{(1/3)})$$

$$2 + \sqrt{3}$$

Example: To simplify $\cos(2x) + (\sin(x))^2$ (in the Radian mode)

Menu Item: [Action][Transformation][simplify]

$$\text{simplify}(\cos(2x) + \sin(x)^2)$$

$$(\cos(x))^2$$

• expand

Function: Expands an expression.

Syntax: expand (Exp/Eq/Ineq/List/Mat [])

expand (Exp,variable [])

- Ineq (inequality) includes the “≠” (not equal to) relational operator.
- If you specify a variable, Exp is decomposed into partial fractions, with respect to the variable.

Example: To expand $(x + 2)^2$

Menu Item: [Action][Transformation][expand]

$$\text{expand}((x+2)^2)$$

$$x^2 + 4x + 4$$

Example: To decompose $\frac{1}{(x^4 - 1)}$ into partial fractions, with respect to x

Menu Item: [Action][Transformation][expand]

$$\text{expand}\left(\frac{1}{x^4 - 1}, x\right)$$

$$\frac{1}{4 \cdot (x-1)} - \frac{1}{4 \cdot (x+1)} - \frac{1}{2 \cdot (x^2 + 1)}$$

• factor

Function: Factors an expression.

Syntax: factor (Exp/Eq/Ineq/List/Mat [])

- Ineq (inequality) includes the “≠” (not equal to) relational operator.

Example: To factor $x^2 - 4x + 4$

Menu Item: [Action][Transformation][factor]

$$\text{factor}(x^2 - 4x + 4)$$

$$(x-2)^2$$



• **rFactor**

Function: Factors an expression up to its roots, if any.

Syntax: rFactor (Exp/Eq/Ineq/List/Mat [])

- Ineq (inequality) includes the “≠” (not equal to) relational operator.

Example: To factor $x^2 - 3$

Menu Item: [Action][Transformation][rFactor]

$$\boxed{\text{rFactor}(x^2-3) \\ (x-\sqrt{3}) \cdot (x+\sqrt{3})}$$

• **factorOut**

Function: Factors out an expression with respect to a specified factor.

Syntax: factorOut (Exp/Eq/Ineq/List/Mat, Exp [])

- Ineq (inequality) includes the “≠” (not equal to) relational operator.

Example: To factor “a” out $ax^2 + bx + c$

Menu Item: [Action][Transformation][factorOut]

$$\boxed{\text{factorOut}(ax^2+bx+c, a) \\ a \cdot \left(x^2 + \frac{1}{a} \cdot b \cdot x + \frac{1}{a} \cdot c \right)}$$

• **combine**

Function: Transforms multiple fractions into their common denominator equivalents and reduces them, if possible.

Syntax: combine (Exp/Eq/Ineq/List/Mat [])

- Ineq (inequality) includes the “≠” (not equal to) relational operator.

Example: To transform and reduce $(x + 1)/(x + 2) + x(x + 3)$

Menu Item: [Action][Transformation][combine]

$$\boxed{\text{combine}((x+1)/(x+2)+x(x+3)) \\ \frac{x^3+5 \cdot x^2+7 \cdot x+1}{x+2}}$$

• **collect**

Function: Rearranges an expression with respect to a specific variable.

Syntax: collect (Exp/Eq/Ineq/List/Mat[,Exp] [])

- Ineq (inequality) includes the “≠” (not equal to) relational operator.

Example: To rearrange $x^2 + ax + bx$ with respect to x

Menu Item: [Action][Transformation][collect]

$$\boxed{\text{collect}(x^2+ax+bx) \\ x^2+(a+b) \cdot x}$$

- “x” is the default when you omit “[,Exp]”.



• **tExpand**

Function: Employs the sum and difference formulas to expand a trigonometric function.

Syntax: tExpand(Exp/Eq/Ineq/List/Mat [])

- Ineq (inequality) includes the “≠” (not equal to) relational operator.

Example: To expand $\sin(a + b)$

Menu Item: [Action][Transformation][tExpand]

$$\begin{array}{l} \text{tExpand}(\sin(a+b)) \\ \cos(b) \cdot \sin(a) + \sin(b) \cdot \cos(a) \end{array}$$

• **tCollect**

Function: Employs the product to sum formulas to transform the product of a trigonometric function into an expression in the sum form.

Syntax: tCollect (Exp/Eq/Ineq/List/Mat [])

- Ineq (inequality) includes the “≠” (not equal to) relational operator.

Example: To transform $\cos(a) \times \cos(b)$ into an expression in the sum form

Menu Item: [Action][Transformation][tCollect]

$$\begin{array}{l} \text{tCollect}(\cos(a) \times \cos(b)) \\ \frac{\cos(a+b) + \cos(a-b)}{2} \end{array}$$

• **expToTrig**

Function: Transforms an exponent into a trigonometric or hyperbolic function.

Syntax: expToTrig (Exp/Eq/Ineq/List/Mat [])

- Ineq (inequality) includes the “≠” (not equal to) relational operator.

Example: To transform e^{ix} into a trigonometric function (Radian mode)

Menu Item: [Action][Transformation][expToTrig]

$$\begin{array}{l} \text{expToTrig}(e^{ix}) \\ \cos(x) + \sin(x) \cdot i \end{array}$$

• **trigToExp**

Function: Transforms a trigonometric or hyperbolic function into exponential form.

Syntax: trigToExp (Exp/Eq/Ineq/List/Mat [])

- Ineq (inequality) includes the “≠” (not equal to) relational operator.

Example: To transform $\cosh x$ into exponential form

Menu Item: [Action][Transformation][trigToExp]

$$\begin{array}{l} \text{trigToExp}(\cosh(x)) \\ \frac{e^x + e^{-x}}{2} \end{array}$$

• **toFrac**

Function: Transforms a decimal value into its equivalent fraction value.

Syntax: toFrac (Exp/Eq/Ineq/List/Mat [])

- Ineq (inequality) includes the “≠” (not equal to) relational operator.

Example: To transform 5.28 into its equivalent fraction value

Menu Item: [Action][Transformation][toFrac]

$$\begin{array}{l} \text{toFrac}(5.28) \\ \frac{132}{25} \end{array}$$



• **propFrac**

Function: Transforms a decimal value into its equivalent proper fraction value.

Syntax: propFrac (Exp/Eq/Ineq/List/Mat [])

- Ineq (inequality) includes the “≠” (not equal to) relational operator.

Example: To transform 1.2 into its equivalent proper fraction value

Menu Item: [Action][Transformation][propFrac]

propFrac(1.2)	$1 + \frac{1}{5}$
---------------	-------------------

Example: To divide x^2 by $(x - 1)$

Menu Item: [Action][Transformation][propFrac]

propFrac($x^2/(x-1)$)	$\frac{1}{x-1} + x + 1$
-------------------------	-------------------------

• **dms**

Function: Transforms a DMS format value into its equivalent degrees-only value.

Syntax: dms (Exp/List-1 [,Exp/List-2][,Exp/List-3] [])

Example: To transform (3, 5, 6) (= 3° 5' 6") into its equivalent degrees-only value

Menu Item: [Action][Transformation][dms]

dms(3,5,6)	$\frac{617}{200}$
------------	-------------------

- Zero is the default when you omit [,Exp/List-2] or [,Exp/List-3][] .

• **toDMS**

Function: Transforms a degrees-only value into its equivalent DMS format value.

Syntax: toDMS (Exp/List [])

Example: To transform 3.085 degrees into its equivalent DMS format value

Menu Item: [Action][Transformation][toDMS]

toDMS(3.085)	dms(3,5,6)
--------------	------------

Using the Advanced Submenu

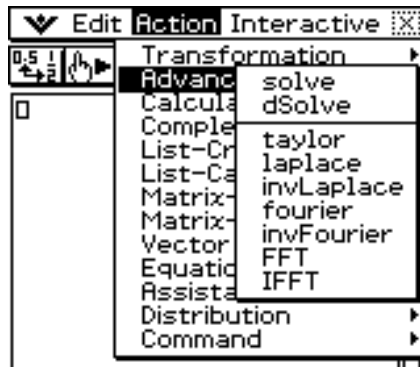

- **solve**

For information about solve, see page 2-8-43.

- **dSolve**

For information about dSolve, see page 2-8-44.

- **taylor**

Function: Finds a Taylor polynomial for an expression with respect to a specific variable.

Syntax: `taylor (Exp/List, variable, order [,center point] [])`

Example: To find a 5th order Taylor polynomial for $\sin(x)$ with respect to $x = 0$ (in the Radian mode)

Menu Item: [Action][Advanced][taylor]

```
taylor(sin(x),x,5,0)
      x5 - x3
      120  6 +x
```

- Zero is the default when you omit “[,center point]”.

- **laplace, invLaplace**

“laplace” is the command for the Laplace transform, and “invLaplace” is the command for the inverse of Laplace transform.

$$L[f(t)](s) = \int_0^{\infty} f(t)e^{-st} dt$$

Function:

The Laplace Transform is called “laplace” on the ClassPad.

The inverse of Laplace Transform is called “invLaplace” on the ClassPad.

Syntax: `laplace(f(t), t, s)`

$f(t)$ -- expression

t -- variable with respect to which the expression is transformed

s -- parameter of the transform

`invLaplace(L(s), s, t)`

$L(s)$ -- expression

s -- variable with respect to which the expression is transformed

t -- parameter of the transform

ClassPad supports transform of the following functions.

$\sin(x)$, $\cos(x)$, $\sinh(x)$, $\cosh(x)$, x^n , \sqrt{x} , e^x , $\text{heaviside}(x)$, $\text{delta}(x)$, $\text{delta}(x, n)$

ClassPad does not support transform of the following functions.

$\tan(x)$, $\sin^{-1}(x)$, $\cos^{-1}(x)$, $\tan^{-1}(x)$, $\tanh(x)$, $\sinh^{-1}(x)$, $\cosh^{-1}(x)$, $\tanh^{-1}(x)$, $\log(x)$, $\ln(x)$, $1/x$, $\text{abs}(x)$, $\text{gamma}(x)$

Laplace Transform of a Differential Equation

The laplace command can be used to solve ordinary differential equations. ClassPad does not support System of Differential Equations for laplace.

Syntax: `laplace(diff eq, x, y, t)`

`diff eq` -- differential equation to solve

`x` -- independent variable in the diff eq

`y` -- dependent variable in the diff eq

`t` -- parameter of the transform

Lp means $F(s)=L[f(t)]$ in the result of transform for a differential equation.

An example using Laplace to solve a differential equation:

$$x' + 2x = e^{-t} \text{ where } x(0) = 3$$

```
laplace(x'+2x=e^-t, t, x, s)
      -x(0)+Lp*s+2*Lp= 1/(s+1)
ans|x(0)=3
      Lp*s+2*Lp-3= 1/(s+1)
solve(ans, Lp)
      { Lp= (3*s)/(s^2+3*s+2) + 4/(s^2+3*s+2) }
invlaplace(getright(ans[1]), s, t)
      e^-t+2*e^-2*t
```

• fourier, invFourier

Function: “fourier” is the command for the Fourier Transform, and “invFourier” is the command for the inverse Fourier Transform.

Syntax: `fourier(f(x), x, w, n)`

`invFourier(f(w), w, x, n)`

`f(x)` -- expression

`x` -- variable with respect to which the expression is transformed with

`w` -- parameter of the transform

`n` -- 0 to 4, indicating Fourier parameter to use (optional)

ClassPad supports transform of the following functions.

$\sin(t)$, $\cos(t)$, $\log(t)$, $\ln(t)$, $\text{abs}(t)$, $\text{signum}(t)$, $\text{heaviside}(t)$, $\text{delta}(t)$, $\text{delta}(t, n)$, e^{ti}

ClassPad does not support transform of the following functions.

$\tan(t)$, $\sin^{-1}(t)$, $\cos^{-1}(t)$, $\tan^{-1}(t)$, $\sinh(t)$, $\cosh(t)$, $\tanh(t)$, $\sinh^{-1}(t)$, $\cosh^{-1}(t)$, $\tanh^{-1}(t)$, $\text{gamma}(t)$, \sqrt{t} , e^t

The Fourier Transform pairs are defined using two arbitrary constants a , b .

$$F(\omega) = \sqrt{\frac{|b|}{(2\pi)^{1-a}}} \int_{-\infty}^{\infty} f(t) e^{ib\omega t} dt$$

$$f(t) = \sqrt{\frac{|b|}{(2\pi)^{1+a}}} \int_{-\infty}^{\infty} F(\omega) e^{-ib\omega t} d\omega$$

The values of a and b depend on the scientific discipline, which can be specified by the value of n (optional fourth parameter of Fourier and invFourier) as shown below.

	n (optional)	a	b	Definition of the Fourier Integral
Modern Physics	0	0	1	$\frac{\sqrt{2} \cdot \int_{-\infty}^{\infty} e^{i\omega \cdot x} \cdot f(x) dx}{2 \cdot \sqrt{\pi}}$
Pure Math	1	1	-1	$\int_{-\infty}^{\infty} e^{-i\omega \cdot x} \cdot f(x) dx$
Probability	2	1	1	$\int_{-\infty}^{\infty} e^{i\omega \cdot x} \cdot f(x) dx$
Classical Physics	3	-1	1	$\frac{\int_{-\infty}^{\infty} e^{i\omega \cdot x} \cdot f(x) dx}{2 \cdot \pi}$
Signal Processing	4	0	$-2^* \pi$	$\int_{-\infty}^{\infty} e^{-2 \cdot \pi \cdot i \cdot \omega \cdot x} \cdot f(x) dx$

Tip

- The Advanced Format dialog box can be used to configure settings related to the Fourier Transform, such a Fourier Transform definition, etc. For details, see “Advanced Format Dialog Box” on page 1-9-11.





• **FFT, IFFT**

Function: “FFT” is the command for the fast Fourier Transform, and “IFFT” is the command for the inverse fast Fourier Transform.

2^n data values are needed to perform FFT and IFFT. On the ClassPad, FFT and IFFT are calculated numerically.

Syntax: FFT(list) or FFT(list, m)

IFFT(list) or IFFT(list, m)

- Data size must be 2^n for $n = 1, 2, 3, \dots$
- The value for m is optional. It can be from 0 to 2, indicating the FFT parameter to use.

$m = 0$ Signal Processing

$m = 1$ Pure Math

$m = 2$ Data Analysis

The Fourier Transform is defined as the following:

$$f(x) = \int_{-\infty}^{\infty} F(k)e^{2\pi ikx} dk$$

$$F(k) = \int_{-\infty}^{\infty} f(x)e^{-2\pi ikx} dx$$

Some authors (especially physicists) prefer to write the transform in terms of angular frequency $\omega \equiv 2\pi\nu$ instead of the oscillation frequency ν .

However, this destroys the symmetry, resulting in the transform pair shown below.

$$H(\omega) = F[h(t)] = \int_{-\infty}^{\infty} h(t)e^{-i\omega t} dt$$

$$h(t) = F^{-1}[H(\omega)] = \frac{1}{2\pi} \int_{-\infty}^{\infty} H(\omega)e^{i\omega t} d\omega$$

To restore the symmetry of the transforms, the convention shown below is sometimes used.

$$g(y) = F[f(t)] = \frac{1}{\sqrt{2\pi}} \int_{-\infty}^{\infty} f(t)e^{-iyt} dt$$

$$f(t) = F^{-1}[g(y)] = \frac{1}{\sqrt{2\pi}} \int_{-\infty}^{\infty} g(y)e^{iyt} dy$$

In general, the Fourier transform pair may be defined using two arbitrary constants a and b as shown below.

$$F(\omega) = \sqrt{\frac{|b|}{(2\pi)^{1-a}}} \int_{-\infty}^{\infty} f(t) e^{ib\omega t} dt$$

$$f(t) = \sqrt{\frac{|b|}{(2\pi)^{1+a}}} \int_{-\infty}^{\infty} F(\omega) e^{-ib\omega t} d\omega$$

Unfortunately, a number of conventions are in widespread use for a and b . For example, $(0, 1)$ is used in modern physics, $(1, -1)$ is used in pure mathematics and systems engineering, $(1, 1)$ is used in probability theory for the computation of the characteristic function, $(-1, 1)$ is used in classical physics, and $(0, -2\pi)$ is used in signal processing.

Tip

- The Advanced Format dialog box can be used to configure Fast Fourier Transform settings. For details, see “Advanced Format Dialog Box” on page 1-9-11.

Using the Calculation Submenu

The [Calculation] submenu contains calculus related commands, such as “diff” (differentiation) and “ \int ” (integration).

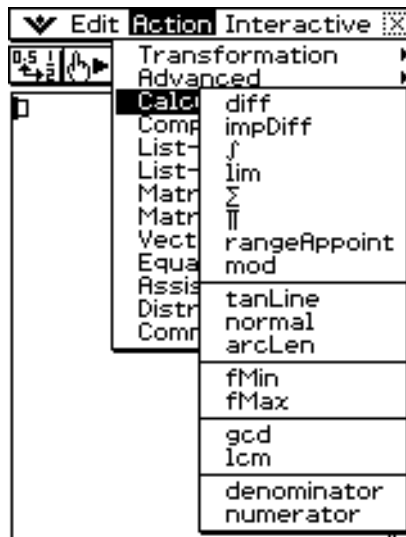



• **diff**

Function: Differentiates an expression with respect to a specific variable.

Syntax: `diff(Exp/List[,variable] [])`

`diff(Exp/List,variable,order[,a] [])`

- “a” is the point for which you want to determine the derivative.
- “order” = 1 when you use the following syntax: `diff(Exp/List[,variable][])`. The default variable is “x” when “variable” is omitted.

Example: To differentiate x^6 with respect to x

Menu Item: [Action][Calculation][diff]

$$\text{diff}(x^6) \quad 6 \cdot x^5$$

Example: To find the second derivative of x^6 with respect to x

Menu Item: [Action][Calculation][diff]

$$\text{diff}(x^6, x, 2) \quad 30 \cdot x^4$$

Example: To find the second derivative of x^6 with respect to x at $x = 3$

Menu Item: [Action][Calculation][diff]

$$\text{diff}(x^6, x, 2, 3) \quad 2430$$

• **impDiff**

Function: Differentiates an equation or expression in implicit form with respect to a specific variable.

Syntax: `impDiff(Eq/Exp/List, independent variable, dependent variable)`

Example: To find y' using implicit differentiation

Menu Item: [Action][Calculation][impDiff]

$$\text{impDiff}(x+y=x/y, x, y) \quad y' = \frac{-y^2}{y^2+x} + \frac{y}{y^2+x}$$

Example: To find y'' given $y' = -x/y$

Menu Item: [Action][Calculation][impDiff]

$$\text{impDiff}(-x/y, x, y) \quad \frac{x \cdot y'}{y^2} - \frac{1}{y}$$

Example: To find y' for a list of equations

Menu Item: [Action][Calculation][impDiff]

$$\text{impDiff}(\{y^2-x^2=3, y/x=1/y^2\}, x, y) \quad \left\{ y' = \frac{x}{y}, y' = \frac{y^4}{2 \cdot x^2 + x \cdot y^3} \right\}$$

Important!

The derivative symbol (') cannot be used in the argument of “impDiff()”. Trying to use a derivative symbol would result in a Wrong Argument Type error.

• \int

Function: Integrates an expression with respect to a specific variable.

Syntax: $f(\text{Exp/List}[, \text{variable}] [])$

$f(\text{Exp/List}, \text{variable}, \text{lower limit}, \text{upper limit} [, \text{tol}] [])$

- “ x ” is the default when you omit $[\text{variable}]$.
- “ tol ” represents the allowable error range.
- This command returns an approximate value when a range is specified for “ tol ”.
- This command returns the true value of a definite interval when nothing is specified for “ tol ”. If the true value cannot be obtained, however, this command returns an approximate value along with $tol = 1E - 5$.

Example: To integrate x with respect to x

Menu Item: [Action][Calculation][\int]

$$\int(x)$$

$$\frac{x^2}{2}$$

Example: To integrate $\frac{1}{x \times \ln(x)}$ with respect to x between $x = 1$ and $x = 2$

Menu Item: [Action][Calculation][\int]

$$\int(1/(x \times \ln(x)), x, 1, 2)$$

$$\infty$$

Example: To integrate $2x^2 + 3x + 4$ with respect to x between $x = 1$ and $x = 5$, with an allowable error range of $1E - 4$

Menu Item: [Action][Calculation][\int]

$$\int(2x^2+3x+4, x, 1, 5, 1E-4)$$

$$134.6666667$$



- **lim**

Function: Determines the limit of an expression.

Syntax: $\text{lim}(\text{Exp/List}, \text{variable}, \text{point} [\text{,direction}] [])$

Example: To determine the limit of e^{-x} as x approaches ∞

Menu Item: [Action][Calculation][lim]

$$\text{lim}(e^{-x}, x, \infty) \quad 0$$

Example: To determine the limit of $1/x$ as x approaches 0 from the right

Menu Item: [Action][Calculation][lim]

$$\text{lim}(1/x, x, 0, 1) \quad \infty$$

Example: To determine the limit of $1/x$ as x approaches 0 from the left

Menu Item: [Action][Calculation][lim]

$$\text{lim}(1/x, x, 0, -1) \quad -\infty$$

- This function returns the limit from the left when “direction” < 0, the limit from the right when “direction” > 0, and the limit from both sides (left and right) when “direction” = 0 or when the direction is omitted.

- **Σ**

Function: Evaluates an expression at discrete variable values within a range, and then calculates a sum.

Syntax: $\Sigma(\text{Exp/List}, \text{variable}, \text{lower value}, \text{upper value} [])$

Example: To calculate the sum of x^2 as the value of x changes from $x = 1$ through $x = 10$.

Menu Item: [Action][Calculation][Σ]

$$\Sigma(x^2, x, 1, 10) \quad 385$$

- **Π**

Function: Evaluates an expression at discrete variable values within a range, and then calculates a product.

Syntax: $\Pi(\text{Exp/List}, \text{variable}, \text{lower value}, \text{upper value} [])$

Example: To calculate the product of x^2 as the value of x changes from $x = 1$ through $x = 5$

Menu Item: [Action][Calculation][Π]

$$\Pi(x^2, x, 1, 5) \quad 14400$$



• rangeAppoint

Function: Finds an expression or value that satisfies a condition in a specified range.

Syntax: rangeAppoint (Exp/Eq/List, start value, end value [])

- When using an equation (Eq) for the first argument, input the equation using the syntax Var = Exp. Evaluation will not be possible if any other syntax is used.

Example: To find the expression(s) in the list $\{x = \pi, x = 2\pi, x = 3\pi\}$ that belong(s) to the closed range $0 \leq x \leq 5$

Menu Item: [Action][Calculation]
[rangeAppoint]

```
rangeAppoint({X=π, X=2×π, X=3×π}, 0, 5)
           {x=π}
```

Example: To find the “n” that satisfies the condition $0 \leq n \times \pi \leq 5$

Menu Item: [Action][Calculation][rangeAppoint]

```
rangeAppoint(constn(1)×π, 0, 5)
           {0, π}
```

• mod

Function: Returns the remainder when one expression is divided by another expression.

Syntax: mod ({Exp/List} -1, {Exp/List} -2 [])

Example: To determine the remainder when 26 is divided by 3 (26mod3)

Menu Item: [Action][Calculation][mod]

```
mod(26, 3)
           2
```

• tanLine

Function: Returns the right side of the equation for the tangent line ($y = \text{'expression'}$) to the curve at the specified point.

Syntax: tanLine (Exp/List, variable, variable value at point of tangency [])

Example: To determine the function of the line tangent to $y = x^3$ at $x = 2$

Menu Item: [Action][Calculation][tanLine]

```
tanLine(X^3, X, 2)
           12·x-16
```

• normal

Function: Returns the right side of the equation for the line normal ($y = \text{'expression'}$) to the curve at the specified point.

Syntax: normal (Exp/List, variable, variable value at point of normal [])

Example: To determine the function of the line normal to $y = x^3$ at $x = 2$

Menu Item: [Action][Calculation][normal]

```
normal(X^3, X, 2)
           -x/12 + 49/6
```

• arcLen

Function: Returns the arc length of an expression from a start value to an end value with respect to a specified variable.

Syntax: arcLen (Exp/List, variable, start value, end value [])

Example: To determine the arc length for $y = x^{3/2}$ from $x = 0$ to $x = 4$

Menu Item: [Action][Calculation][arcLen]

```
arcLen(X^(3/2), X, 0, 4)
           80·√10/27 - 8/27
```



- **fMin**

Function: Returns the minimum point in a specific range of a function.

Syntax: fMin(Exp[,variable] [])

fMin(Exp,variable,start value,end value[,n] [])

- “ x ” is the default when you omit “[,variable]”.
- Negative infinity and positive infinity are the default when the syntax fMin (Exp [,variable] []) is used.
- “ n ” is calculation precision, which you can specify as an integer in the range of 1 to 9. Using any value outside this range causes an error.
- This command returns an approximate value when calculation precision is specified for “ n ”.
- This command returns a true value when nothing is specified for “ n ”. If the true value cannot be obtained, however, this command returns an approximate value along with $n = 4$.
- Discontinuous points or sections that fluctuate widely can adversely affect precision or even cause an error.
- Inputting a larger number for “ n ” increases the precision of the calculation, but it also increases the amount of time required to perform the calculation.
- The value you input for the end point of the interval must be greater than the value you input for the start point. Otherwise an error occurs.

Example: To find the minimum point of $x^2 - 1$ with respect to x

Menu Item: [Action][Calculation][fMin]

```
fMin(x^2-1,x)
{MinValue=-1,x=0}
```

Example: To find the minimum point of $x^2 - 1$ with respect to x , when $2 \leq x \leq 3$

Menu Item: [Action][Calculation][fMin]

```
fMin(x^2-1,x,2,3)
{MinValue=3,x=2}
```

Example: To find the minimum point of $x^3 - 6x$ with respect to x ,
when $-2 \leq x \leq 2$ and $n = 1$

Menu Item: [Action][Calculation][fMin]

```
fMin(x^3-6x,x,-2,2,1)
{MinValue=-5.656779,x=1.41}
```



• fMax

Function: Returns the maximum point in a specific range of a function.

Syntax: fMax(Exp[,variable] [])

fMax(Exp,variable,start value,end value[,n] [])

- “x” is the default when you omit “[,variable]”.
- Negative infinity and positive infinity are the default when the syntax fMax (Exp [, variable] []) is used.
- “n” is calculation precision, which you can specify as an integer in the range of 1 to 9. Using any value outside this range causes an error.
- This command returns an approximate value when calculation precision is specified for “n”.
- This command returns a true value when nothing is specified for “n”. If the true value cannot be obtained, however, this command returns an approximate value along with $n = 4$.
- Discontinuous points or sections that fluctuate widely can adversely affect precision or even cause an error.
- Inputting a larger number for “n” increases the precision of the calculation, but it also increases the amount of time required to perform the calculation.
- The value you input for the end point of the interval must be greater than the value you input for the start point. Otherwise an error occurs.

Example: To find the maximum point of $-x^2 + 1$ with respect to x

Menu Item: [Action][Calculation][fMax]

```
fMax(-x^2+1,x)
{MaxValue=1,x=0}
```

Example: To find the maximum point of $-x^2 + 1$, when $2 \leq x \leq 5$

Menu Item: [Action][Calculation][fMax]

```
fMax(-x^2+1,x,2,5)
{MaxValue=-3,x=2}
```

Example: To find the maximum point of $x^3 - 6x$ with respect to x ,
when $-2 \leq x \leq 2$ and $n = 1$

Menu Item: [Action][Calculation][fMax]

```
fMax(x^3-6x,x,-2,2,1)
{MaxValue=5.656779,x=-1.41}
```

• gcd

Function: Returns the greatest common denominator of two expressions.

Syntax: gcd (Exp/List-1, Exp/List-2 [])

Example: To obtain the greatest common denominator of $x + 1$ and $x^2 - 3x - 4$

Menu Item: [Action][Calculation][gcd]

```
gcd(x+1,x^2-3x-4)
x+1
```

- **lcm**

Function: Returns the least common multiple of two expressions.

Syntax: lcm (Exp/List-1, Exp/List-2 [])

Example: To obtain the least common multiple of $x^2 - 1$ and $x^2 + 2x - 3$

Menu Item: [Action][Calculation][lcm]

$$\text{lcm}(x^2-1, x^2+2x-3)$$

$$(x+1) \cdot (x^2+2 \cdot x-3)$$

- **denominator**

Function: Extracts the denominator of a fraction.

Syntax: denominator (Exp/List [])

Example: To extract the denominator of the fraction $(y - 2)/(x + 1)$

Menu Item: [Action][Calculation][denominator]

$$\text{denominator}((y-2)/(x+1))$$

$$x+1$$

- **numerator**

Function: Extracts the numerator of a fraction.

Syntax: numerator (Exp/List [])

Example: To extract the numerator of the fraction $(y - 2)/(x + 1)$

Menu Item: [Action][Calculation][numerator]

$$\text{numerator}((y-2)/(x+1))$$

$$y-2$$

Using the Complex Submenu

The [Complex] submenu contains commands that relate to calculations that involve complex numbers.

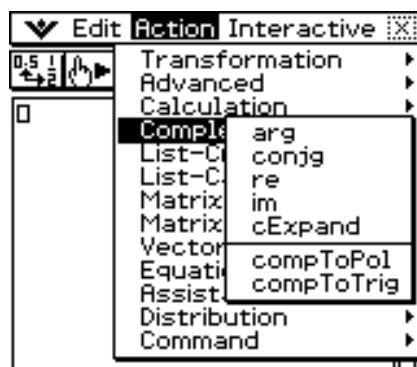

- **arg**

Function: Returns the argument of a complex number.

Syntax: arg (Exp/Eq/List/Mat [])

Example: To obtain the argument of complex $2 + i$ (in the Radian mode)

Menu Item: [Action][Complex][arg]

$$\text{arg}(2+i)$$

$$\tan^{-1}\left(\frac{1}{2}\right)$$

- **conjg**

Function: Returns the conjugate complex number.

Syntax: conjg (Exp/Eq/List/Mat [])

- An inequality with the “≠” (not equal to) relation symbol is also included (only in the Real mode).

Example: To obtain the conjugate of complex number $1 + i$

Menu Item: [Action][Complex][conjg]

conjg(1+i)	1-i
------------	-----

- **re**

Function: Returns the real part of a complex number.

Syntax: re (Exp/Eq/List/Mat [])

- An inequality with the “≠” (not equal to) relation symbol is also included (only in the Real mode).

Example: To obtain the real part of complex number $3 - 4i$

Menu Item: [Action][Complex][re]

re(3-4i)	3
----------	---

- **im**

Function: Returns the imaginary part of a complex number.

Syntax: im (Exp/Eq/List/Mat [])

- An inequality with the “≠” (not equal to) relation symbol is also included (only in the Real mode).

Example: To obtain the imaginary part of complex number $3 - 4i$

Menu Item: [Action][Complex][im]

im(3-4i)	-4
----------	----

- **cExpand**

Function: Expands a complex expression to rectangular form $(a + bi)$.

Syntax: cExpand (Exp/Eq/List/Mat [])

- Ineq (inequality) includes the “≠” (not equal to) relational operator.
- The variables are regarded as real numbers.

Example: To expand $\cos^{-1}(2)$ (in the Radian mode)

Menu Item: [Action][Complex][cExpand]

cExpand(cos ⁻¹ ((2)))	$\ln(\sqrt{3} + 2) \cdot i$
----------------------------------	-----------------------------

• compToPol

Function: Transforms a complex number into its polar form.

Syntax: compToPol (Exp/Eq/List/Mat [])

- Ineq (inequality) includes the “≠” (not equal to) relational operator.

Example: To transform $1 + i$ into its polar form (in the Radian mode)

Menu Item: [Action][Complex][compToPol]

$$\text{compToPol}(1+i)$$

$$\sqrt{2} \cdot e^{\frac{\pi \cdot i}{4}}$$

• compToTrig

Function: Transforms a complex number into its trigonometric/hyperbolic form.

Syntax: compToTrig (Exp/Eq/List/Mat [])

- Ineq (inequality) includes the “≠” (not equal to) relational operator.

Example: To transform $1 + i$ into its trigonometric form (in the Radian mode)

Menu Item: [Action][Complex][compToTrig]

$$\text{compToTrig}(1+i)$$

$$\sqrt{2} \cdot \left(\cos\left(\frac{\pi}{4}\right) + \sin\left(\frac{\pi}{4}\right) \cdot i \right)$$

Using the List-Create Submenu

The [List-Create] submenu contains commands that are related to creating lists.

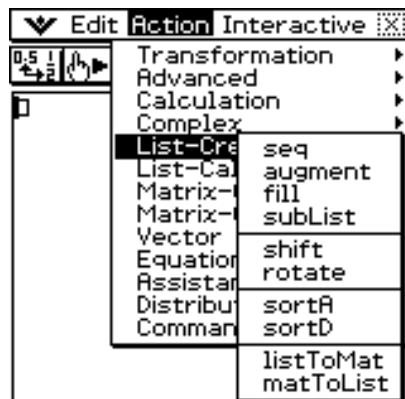

- **seq**

Function: Generates a list in accordance with a numeric sequence expression.

Syntax: seq (Exp, variable, start value, end value [,step size] [])

Example: To generate a list in accordance with the expression $x^2 + 2x$ when the start value is 1, the end value is 5, and the step size is 2

Menu Item: [Action][List-Create][seq]

```
seq(x^2+2x, x, 1, 5, 2)
(3, 15, 35)
```

- “1” is the default when you omit “[,step size]”.
- The step size must be a factor of the difference between the start value and the end value.

- **augment**

Function: Creates a new list by appending one list to another.

Syntax: augment (List-1, List-2 [])

Example: To combine list {1, 2} and list {3, 4}

Menu Item: [Action][List-Create][augment]

```
augment({1,2},{3,4})
(1,2,3,4)
```

- **fill**

Function: Replaces the elements of a list with a specified value or expression. This command can also be used to create a new list whose elements all contain the same value or expression, or a new list in which the frequency of each element in the first list is determined by the corresponding element in the second list.

Syntax: fill (Exp/Eq/Ineq, number of elements [])

fill (Exp/Eq/Ineq, List [])

- Ineq (inequality) includes the “≠” (not equal to) relational operator.

Syntax: fill (List, List [])

Example: To create a list consisting of four identical elements (2)

Menu Item: [Action][List-Create][fill]

```
fill(2,4)
(2,2,2,2)
```

Example: To replace the elements of the list {1, 2, 3} with 3

Menu Item: [Action][List-Create][fill]

```
fill(3,{1,2,3})
(3,3,3)
```

Example: To create a list in which the frequencies of a, b and c are 1, 2 and 3, respectively

Menu Item: [Action][List-Create][fill]

```
fill({a,b,c},{1,2,3})
(a,b,b,c,c,c)
```



- **subList**

Function: Extracts a specific section of a list into a new list.

Syntax: subList (List [,start number] [,end number] [])

Example: To extract the second through the fourth elements of the list {1, 2, 3, 4, 5}

Menu Item: [Action][List-Create][subList]

```
subList({1,2,3,4,5},2,4)
      {2,3,4}
```

- The leftmost element is the default when you omit “[,start number]”, and the rightmost element is the default when you omit “[,end number]”.

- **shift**

Function: Returns a list in which elements have been shifted to the right or left by a specific amount.

Syntax: shift (List [,number of shifts] [])

- Specifying a negative value for “[,number of shifts]” shifts to the right, while a positive value shifts to the left.

Example: To shift the elements of the list {1, 2, 3, 4, 5, 6} to the left by three

Menu Item: [Action][List-Create][shift]

```
shift({1,2,3,4,5,6},3)
{4,5,6,Undefined,Undefined,Undefined}
```

- Right shift by one (–1) is the default when you omit “[,number of shifts]”.

- **rotate**

Function: Returns a list in which the elements have been rotated to the right or to the left by a specific amount.

Syntax: rotate (List [,number of rotations] [])

- Specifying a negative value for “[,number of rotations]” rotates to the right, while a positive value rotates to the left.

Example: To rotate the elements of the list {1, 2, 3, 4, 5, 6} to the left by two

Menu Item: [Action][List-Create][rotate]

```
rotate({1,2,3,4,5,6},2)
      {3,4,5,6,1,2}
```

- Right rotation by one (–1) is the default when you omit “[,number of rotations]”.

- **sortA**

Function: Sorts the elements of the list into ascending order.

Syntax: sortA (List [])

Example: To sort the elements of the list {1, 5, 3} into ascending order

Menu Item: [Action][List-Create][sortA]

```
sortA({1,5,3})
      {1,3,5}
```

- **sortD**

Function: Sorts the elements of the list into descending order.

Syntax: `sortD (List [])`

Example: To sort the elements of the list {1, 5, 3} into descending order

Menu Item: [Action][List-Create][sortD]

```
sortD({1,5,3})
      {5,3,1}
```

- **listToMat**

Function: Transforms lists into a matrix.

Syntax: `listToMat (List-1 [, List-2, ..., List-N] [])`

Example: To transform the lists {3, 5} and {2, 4} into a matrix

Menu Item: [Action][List-Create][listToMat]

```
listToMat({3,5},{2,4})
          [ 3 2 ]
          [ 5 4 ]
```

- **matToList**

- For information about matToList, see page 2-8-33.

Using the List-Calculation Submenu

The [List-Calculation] submenu contains commands related to list calculations.

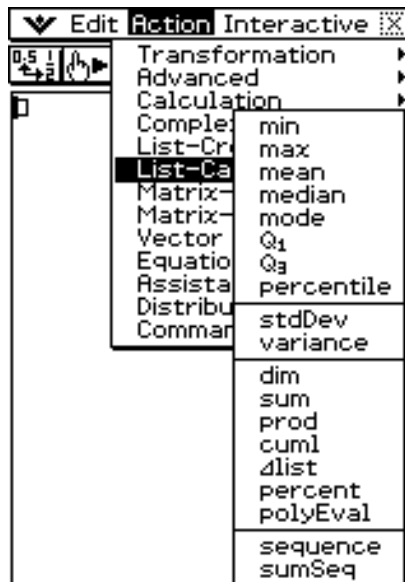

- **min**

Function: Returns the minimum value of an expression or the elements in a list.

Syntax: min (Exp/List-1[, Exp/List-2] [])

Example: To determine the minimum values of the elements in list {1, 2, 3}

Menu Item: [Action][List-Calculation][min]

min({1,2,3})	1
--------------	---

Example: To compare each element of list {1, 2, 3} with the value 2, and produce a list whose elements contain the lesser value of each comparison

Menu Item: [Action][List-Calculation][min]

min({1,2,3},2)	{1,2,2}
----------------	---------

Example: To compare the elements of list {1, 2, 3} and list {3, 1, 2}, and produce a list whose elements contain the lesser value of each comparison

Menu Item: [Action][List-Calculation][min]

min({1,2,3},{3,1,2})	{1,1,2}
----------------------	---------

- **max**

Function: Returns the maximum value of an expression or the elements of a list.

Syntax: max (Exp/List-1[, Exp/List-2] [])

Example: To determine the maximum value of the elements in list {1, 2, 3}

Menu Item: [Action][List-Calculation][max]

max({1,2,3})	3
--------------	---

Example: To compare each element of list {1, 2, 3} with the value 2, and produce a list whose elements contain the greater value of each comparison

Menu Item: [Action][List-Calculation][max]

max({1,2,3},2)	{2,2,3}
----------------	---------

Example: To compare the elements of list {1, 2, 3} and list {3, 1, 2}, and produce a list whose elements contain the greater value of each comparison

Menu Item: [Action][List-Calculation][max]

max({1,2,3},{3,1,2})	{3,2,3}
----------------------	---------





• **mean**

Function: Returns the mean of the elements in a list.

Syntax: mean (List-1[, List-2] [])

- “List-2” specifies the frequency of each element in “List-1”.

Example: To determine the mean of the elements in list {1, 2, 3}

Menu Item: [Action][List-Calculation][mean]

```
mean({1,2,3})
2
```

Example: To determine the mean of the elements in the list {1, 2, 3}, whose respective frequencies are {3, 2, 1}

Menu Item: [Action][List-Calculation][mean]

```
mean({1,2,3},{3,2,1})
5/3
```

• **median**

Function: Returns the median of the elements in a list.

Syntax: median (List-1[, List-2] [])

- “List-2” specifies the frequency of each element in “List-1”.

Example: To determine the median of the elements in the list {1, 2, 3}

Menu Item: [Action][List-Calculation][median]

```
median({1,2,3})
2
```

Example: To determine the median of the elements in the list {1, 2, 3}, whose respective frequencies are {3, 2, 1}

Menu Item: [Action][List-Calculation][median]

```
median({1,2,3},{3,2,1})
3/2
```

• **mode**

Function: Returns the mode of the elements in a list.

Syntax: mode (List-1[, List-2] [])

- “List-2” specifies the frequency of each element in “List-1”.

Example: To determine the mode of the elements in the list {1, 1, 2, 2, 2}

Menu Item: [Action][List-Calculation][mode]

```
mode({1,1,2,2,2})
2
```

Example: To determine the mode of the elements in the list {1, 2, 3}, whose respective frequencies are {3, 2, 1}

Menu Item: [Action][List-Calculation][mode]

```
mode({1,2,3},{3,2,1})
1
```

- If there are multiple modes, they are returned in a list.

- **Q₁**

Function: Returns the first quartile of the elements in a list.

Syntax: Q₁ (List-1[, List-2] [])

- “List-2” specifies the frequency of each element in “List-1”.

Example: To determine the first quartile of the elements in the list {1, 2, 3, 4, 5}

Menu Item: [Action][List-Calculation][Q₁]

Q ₁ ((1,2,3,4,5))	
	$\frac{3}{2}$

Example: To determine the first quartile of the elements in the list {1, 2, 3, 4}, whose respective frequencies are {4, 3, 2, 1}

Menu Item: [Action][List-Calculation][Q₁]

Q ₁ ((1,2,3,4),(4,3,2,1))	
	1

- **Q₃**

Function: Returns the third quartile of the elements in a list.

Syntax: Q₃ (List-1[, List-2] [])

- “List-2” specifies the frequency of each element in “List-1”.

Example: To determine the third quartile of the elements in the list {1, 2, 3, 4, 5}

Menu Item: [Action][List-Calculation][Q₃]

Q ₃ ((1,2,3,4,5))	
	$\frac{9}{2}$

Example: To determine the third quartile of the elements in the list {1, 2, 3, 4}, whose respective frequencies are {4, 3, 2, 1}

Menu Item: [Action][List-Calculation][Q₃]

Q ₃ ((1,2,3,4),(4,3,2,1))	
	3

- **percentile**

Function: Finds the *n*th percentile point in a list.

Syntax: percentile (list, number)

Percentile = (minimum) + (maximum – minimum) × number where number is %.

percentile((1,2,3,4),70)	
	3.1
1+(4-1)×0.7	
	3.1

- **stdDev**

Function: Returns the sample standard deviation of the elements in a list.

Syntax: stdDev (List [])

Example: To determine the sample standard deviation of the elements in the list {1, 2, 4}

Menu Item: [Action][List-Calculation][stdDev]

stdDev((1,2,4))	
	$\frac{\sqrt{21}}{3}$



- **variance**

Function: Returns the sample variance of the elements in a list.

Syntax: variance (List [])

Example: To determine the sample variance of the elements in the list {1, 2, 4}

Menu Item: [Action][List-Calculation][variance]

variance({1,2,4})	
	$\frac{7}{3}$

- **dim**

Function: Returns the dimension of a list.

Syntax: dim (List [])

Example: To determine the dimension of the list {1, 2, 3}

Menu Item: [Action][List-Calculation][dim]

dim({1,2,3})	
	3

- **sum**

Function: Returns the sum of the elements in a list.

Syntax: sum (List-1[, List-2] [])

- “List-2” specifies the frequency of each element in “List-1”.

Example: To determine the sum of the elements in the list {1, 2, 3}

Menu Item: [Action][List-Calculation][sum]

sum({1,2,3})	
	6

Example: To determine the sum of the elements in the list {1, 2, 3}, whose respective frequencies are {3, 2, 1}

Menu Item: [Action][List-Calculation][sum]

sum({1,2,3},{3,2,1})	
	10

- **prod**

Function: Returns the product of the elements in a list.

Syntax: prod (List-1[, List-2] [])

- “List-2” specifies the frequency of each element in “List-1”.

Example: To determine the product of the elements in the list {1, 2, 3}

Menu Item: [Action][List-Calculation][prod]

prod({1,2,3})	
	6

Example: To determine the product of the elements in the list {1, 2, 3}, whose respective frequencies are {3, 2, 1}

Menu Item: [Action][List-Calculation][prod]

prod({1,2,3},{3,2,1})	
	12

- **cuml**

Function: Returns the cumulative sums of the elements in a list.

Syntax: `cuml (List [])`

Example: To determine the cumulative sums of the elements in the list {1, 2, 3}

Menu Item: [Action][List-Calculation][cuml]

```
cuml({1,2,3})
(1,3,6)
```

- **Δlist**

Function: Returns a list whose elements are the differences between two adjacent elements in another list.

Syntax: `Δlist (List [])`

Example: To generate a list whose elements are the differences between two adjacent elements in the list {1, 2, 4}

Menu Item: [Action][List-Calculation][Δlist]

```
Δlist({1,2,4})
(1,2)
```

- **percent**

Function: Returns the percentage of each element in a list, the sum of which is assumed to be 100.

Syntax: `percent (List [])`

Example: To determine the percentage of each element in the list {1, 2, 3}

Menu Item: [Action][List-Calculation][percent]

```
percent({1,2,3})
{ 50/3, 100/3, 50 }
```

- **polyEval**

Function: Returns a polynomial arranged in the descending order of powers, so coefficients correspond sequentially to each element in the input list.

Syntax: `polyEval (List [,Exp/List] [])`

Example: To create a second degree polynomial with the coefficients {1, 2, 3}

Menu Item: [Action][List-Calculation][polyEval]

```
polyEval({1,2,3})
x2+2·x+3
```

- “x” is the default when you omit “[,Exp/List]”.



• sequence

Function: Returns the lowest-degree polynomial that represents the sequence expressed by the input list. When there are two lists, this command returns a polynomial that maps each element in the first list to its corresponding element in the second list.

Syntax: `sequence (List-1[, List-2] [,variable] [])`

- “x” is the default when you omit “[,variable]”.

Example: To determine a polynomial for a sequence expressed by the list {3, 5, 7, 9}

Menu Item: [Action][List-Calculation][sequence]

```
sequence({3,5,7,9})
2·x+1
```

Example: To determine a polynomial that maps each element in the list {1, 3, 5, 7} to its corresponding element in the list {0, -1, 2, -3}.

Menu Item: [Action][List-Calculation][sequence]

```
sequence({1,3,5,7},{0,-1,2,-3})
-x3/4 + 11·x2/4 - 33·x/4 + 23/4
```

• sumSeq

Function: Finds the lowest-degree polynomial that represents the sequence expressed by the input list and returns the sum of the polynomial. When there are two lists, this command returns a polynomial that maps each element in the first list to its corresponding element in the second list, and returns the sum of the polynomial.

Syntax: `sumSeq (List-1[, List-2] [,variable] [])`

- “x” is the default when you omit “[,variable]”.

Example: To determine the sum of a polynomial for a sequence expressed by the list {3, 5, 7, 9}

Menu Item: [Action][List-Calculation][sumSeq]

```
sumSeq({3,5,7,9})
x2+2·x
```

Example: To obtain the polynomial that maps the elements in the list {9, 7, 4, 1} to its corresponding elements in the list {0, 4, 6, 5}, and return the sum of the polynomial.

Menu Item: [Action][List-Calculation][sumSeq]

```
sumSeq({9,7,4,1},{0,4,6,5})
-x4/320 - 17·x3/1440 + 21·x2/64 + 6749·x/1440
```

Using the Matrix-Create Submenu

The [Matrix-Create] submenu contains commands related to creation of matrices.



- **trn**

Function: Returns a transposed matrix.

Syntax: `trn (Mat [])`

Example: To transpose the matrix $\begin{bmatrix} 1 & 2 \\ 3 & 4 \end{bmatrix}$

Menu Item: [Action][Matrix-Create][trn]

```
trn([[1,2][3,4]])
```

$$\begin{bmatrix} 1 & 3 \\ 2 & 4 \end{bmatrix}$$

- **augment**

Function: Returns a matrix that combines two other matrices.

Syntax: `augment (Mat-1, Mat-2 [])`

Example: To combine the two matrices $\begin{bmatrix} 1 & 2 \\ 3 & 4 \end{bmatrix}$ and $\begin{bmatrix} 5 & 6 \\ 7 & 8 \end{bmatrix}$

Menu Item: [Action][Matrix-Create][augment]

```
augment([[1,2][3,4]],[[5,6][7,8]])
```

$$\begin{bmatrix} 1 & 2 & 5 & 6 \\ 3 & 4 & 7 & 8 \end{bmatrix}$$

- **ident**

Function: Creates an identity matrix.

Syntax: `ident (natural number [])`

Example: To create a 2×2 identity matrix

Menu Item: [Action][Matrix-Create][ident]

```
ident(2)
```

$$\begin{bmatrix} 1 & 0 \\ 0 & 1 \end{bmatrix}$$

- **fill**

Function: Creates a matrix with a specific number of rows and columns, or replaces the elements of a matrix with a specific expression.

Syntax: fill (Exp, number of rows, number of columns [])

fill (Exp, Mat [])

Example: To create a 2×3 matrix, all whose elements are 2

Menu Item: [Action][Matrix-Create][fill]

fill(2,2,3)	$\begin{bmatrix} 2 & 2 & 2 \\ 2 & 2 & 2 \end{bmatrix}$
-------------	--

Example: To replace all of the elements of the matrix $\begin{bmatrix} 1 & 2 \\ 3 & 4 \end{bmatrix}$ with 3

Menu Item: [Action][Matrix-Create][fill]

fill(3,[[1,2],[3,4]])	$\begin{bmatrix} 3 & 3 \\ 3 & 3 \end{bmatrix}$
-----------------------	--

- **subMat**

Function: Extracts a specific section of a matrix into a new matrix.

Syntax: subMat (Mat [,start row] [,start column] [,end row] [,end column] [])

- “1” is the default when you omit “[, start row]” and “[, start column]”.

- The last row number is the default when you omit “[, end row]”.

- The last column number is the default when you omit “[, end column]”.

Example: To extract the section from row 2, column 2, to row 3, column 3 from the matrix $\begin{bmatrix} 1 & 4 & 7 \\ 2 & 5 & 8 \\ 3 & 6 & 9 \end{bmatrix}$

Menu Item: [Action][Matrix-Create][subMat]

[[1,4,7][2,5,8][3,6,9]]≠Mat1	$\begin{bmatrix} 1 & 4 & 7 \\ 2 & 5 & 8 \\ 3 & 6 & 9 \end{bmatrix}$
subMat(Mat1,2,2,3,3)	$\begin{bmatrix} 5 & 8 \\ 6 & 9 \end{bmatrix}$

- **diag**

Function: Returns a one-row matrix containing the elements from the main diagonal of a square matrix.

Syntax: diag (Mat[])

Example: To extract the diagonal elements of the matrix $\begin{bmatrix} 1 & 2 \\ 3 & 4 \end{bmatrix}$

Menu Item: [Action][Matrix-Create][diag]

diag([[1,2],[3,4]])	$\begin{bmatrix} 1 & 4 \end{bmatrix}$
---------------------	---------------------------------------

- **listToMat**

- For information about listToMat, see page 2-8-24.

- **matToList**

Function: Transforms a specific column of a matrix into a list.

Syntax: `matToList (Mat, column number [])`

Example: To transform column 2 of the matrix `[[1, 2] [3, 4]]` into a list

Menu Item: `[Action][Matrix-Create][matToList]`

```
matToList([[1,2][3,4]],2)
(2,4)
```

Using the Matrix-Calculation Submenu

The `[Matrix-Calculation]` submenu contains commands that are related to matrix calculations.

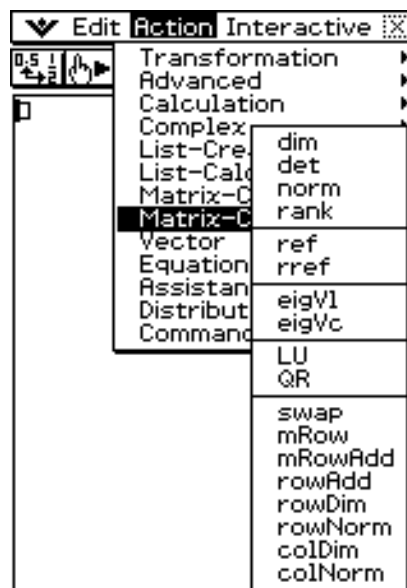

- **dim**

Function: Returns the dimensions of a matrix as a two-element list {number of rows, number of columns}.

Syntax: `dim (Mat [])`

Example: To determine the dimensions of the matrix `[[1, 2, 3] [4, 5, 6]]`

Menu Item: `[Action][Matrix-Calculation][dim]`

```
dim([[1,2,3][4,5,6]])
(2,3)
```

- **det**

Function: Returns the determinant of a square matrix.

Syntax: `det (Mat [])`

Example: To obtain the determinant of the matrix `[[1, 2] [4, 5]]`

Menu Item: `[Action][Matrix-Calculation][det]`

```
det([[1,2][4,5]])
-3
```

- **norm**

Function: Returns the Frobenius norm of the matrix.

Syntax: norm (Mat [])

Example: To determine the norm of the matrix $\begin{bmatrix} 1, 2 \\ 4, 5 \end{bmatrix}$

Menu Item: [Action][Matrix-Calculation][norm]

$$\text{norm}(\begin{bmatrix} 1, 2 \\ 4, 5 \end{bmatrix})$$

$$\sqrt{46}$$

- **rank**

Function: Finds the rank of matrix.

The rank function computes the rank of a matrix by performing Gaussian elimination on the rows of the given matrix. The rank of matrix A is the number of non-zero rows in the resulting matrix.

Syntax: rank (Matrix)

$$\text{rank}(\begin{bmatrix} 1 & 2 & 3 \\ 3 & 4 & 5 \\ 2 & 4 & 6 \end{bmatrix})$$

$$2$$

- **ref**

Function: Returns the row echelon form of a matrix.

Syntax: ref (Mat [])

Example: To obtain the row echelon form of the matrix $\begin{bmatrix} 1, 2, 3 \\ 4, 5, 6 \end{bmatrix}$

Menu Item: [Action][Matrix-Calculation][ref]

$$\text{ref}(\begin{bmatrix} 1, 2, 3 \\ 4, 5, 6 \end{bmatrix})$$

$$\begin{bmatrix} 1 & 2 & 3 \\ 0 & 1 & 2 \end{bmatrix}$$

- **rref**

Function: Returns the reduced row echelon form of a matrix.

Syntax: rref (Mat [])

Example: To obtain the reduced row echelon form of the matrix $\begin{bmatrix} 2, -1, 3, 19 \\ 1, 1, -5, -21 \\ 0, 4, 3, 0 \end{bmatrix}$

Menu Item: [Action]
[Matrix-Calculation][rref]

$$\text{rref}(\begin{bmatrix} 2, -1, 3, 19 \\ 1, 1, -5, -21 \\ 0, 4, 3, 0 \end{bmatrix})$$

$$\begin{bmatrix} 1 & 0 & 0 & 2 \\ 0 & 1 & 0 & -3 \\ 0 & 0 & 1 & 4 \end{bmatrix}$$

- **eigVI**

Function: Returns a list that contains the eigenvalue(s) of a square matrix.

Syntax: eigVI (Mat [])

Example: To obtain the eigenvalue(s) of the matrix $\begin{bmatrix} 3, 4 \\ 1, 3 \end{bmatrix}$

Menu Item: [Action][Matrix-Calculation][eigVI]

$$\text{eigVI}(\begin{bmatrix} 3, 4 \\ 1, 3 \end{bmatrix})$$

$$\{5, 1\}$$

• eigVc

Function: Returns a matrix in which each column represents an eigenvector of a square matrix.

- Since an eigenvector usually cannot be determined uniquely, it is standardized as follows to its norm, which is 1:

$$\text{When } V = [x_1, x_2, \dots, x_n], \sqrt{(|x_1|^2 + |x_2|^2 + \dots + |x_n|^2)} = 1.$$

Syntax: eigVc (Mat [])

Example: To obtain the eigenvector(s) of the matrix $\begin{bmatrix} 3 & 4 \\ 1 & 3 \end{bmatrix}$

Menu Item: [Action][Matrix-Calculation][eigVc]

```
eigVc([[3,4][1,3]])
[0.894427191  -0.894427191]
[0.4472135955  0.4472135955]
```

• LU

Function: Returns the LU decomposition of a square matrix.

Syntax: LU (Mat, lVariableMem, uVariableMem [])

Example: To obtain the LU decomposition of the matrix $\begin{bmatrix} 1 & 2 & 3 \\ 4 & 5 & 6 \\ 7 & 8 & 9 \end{bmatrix}$

- The lower matrix is assigned to the first variable L, while the upper matrix is assigned to the second variable U.

Menu Item: [Action][Matrix-Calculation][LU]

```
LU([[1,2,3][4,5,6][7,8,9]],L,U)
done
```

To display the lower matrix

Menu Item: [VAR][CAP][L][EXE]

```
L
[1 0 0]
[4 1 0]
[7 2 1]
```

To display the upper matrix

Menu Item: [VAR][CAP][U][EXE]

```
U
[1 2 3]
[0 -3 -6]
[0 0 0]
```

• QR

Function: Returns the QR decomposition of a square matrix.

Syntax: QR (Mat, qVariableMem, rVariableMem [])

Example: To obtain the QR decomposition of the matrix $\begin{bmatrix} 1 & 2 \\ 3 & 4 \end{bmatrix}$

- The unitary matrix is assigned to variable Q, while the upper triangular matrix is assigned to variable R.

Menu Item: [Action][Matrix-Calculation][QR]

```
QR([[1,2][3,4]],Q,R)
done
```

To display the unitary matrix

Menu Item: [VAR][CAP][Q][EXE]

Q

$$\begin{bmatrix} \frac{\sqrt{10}}{10} & \frac{3 \cdot \sqrt{10}}{10} \\ \frac{3 \cdot \sqrt{10}}{10} & \frac{-\sqrt{10}}{10} \end{bmatrix}$$

To display the upper triangular matrix

Menu Item: [VAR][CAP][R][EXE]

R

$$\begin{bmatrix} \sqrt{10} & \frac{7 \cdot \sqrt{10}}{5} \\ 0 & \frac{\sqrt{10}}{5} \end{bmatrix}$$

• swap

Function: Swaps two rows of a matrix.

Syntax: swap (Mat, row number-1, row number-2 [])

Example: To swap row 1 with row 2 of the matrix $\begin{bmatrix} 1 & 2 \\ 3 & 4 \end{bmatrix}$

Menu Item: [Action][Matrix-Calculation][swap]

```
swap([[1,2][3,4]],2,1)
[3 4]
[1 2]
```

• mRow

Function: Multiplies the elements of a specific row in a matrix by a specific expression.

Syntax: mRow (Exp, Mat, row number [])

Example: To multiply row 1 of the matrix $\begin{bmatrix} 1 & 2 \\ 3 & 4 \end{bmatrix}$ by x

Menu Item: [Action][Matrix-Calculation][mRow]

```
mRow(x,[[1,2][3,4]],1)
[x 2*x]
[3 4]
```

- **mRowAdd**

Function: Multiplies the elements of a specific row in a matrix by a specific expression, and then adds the result to another row.

Syntax: mRowAdd (Exp, Mat, row number-1, row number-2 [])

Example: To multiply row 1 of the matrix $\begin{bmatrix} 1 & 2 \\ 3 & 4 \end{bmatrix}$ by x , and then add the result to row 2

Menu Item: [Action][Matrix-Calculation][mRowAdd]

$$\text{mRowAdd}(x, \begin{bmatrix} 1 & 2 \\ 3 & 4 \end{bmatrix}, 1, 2)$$

$$\begin{bmatrix} 1 & 2 \\ x+3 & 2 \cdot x+4 \end{bmatrix}$$

- **rowAdd**

Function: Adds a specific matrix row to another row.

Syntax: rowAdd (Mat, row number-1, row number-2 [])

Example: To add row 1 of the matrix $\begin{bmatrix} 1 & 2 \\ 3 & 4 \end{bmatrix}$ to row 2

Menu Item: [Action][Matrix-Calculation][rowAdd]

$$\text{rowAdd}(\begin{bmatrix} 1 & 2 \\ 3 & 4 \end{bmatrix}, 1, 2)$$

$$\begin{bmatrix} 1 & 2 \\ 4 & 6 \end{bmatrix}$$

- **rowDim**

Function: Returns the number in rows in a matrix.

Syntax: rowDim (Mat [])

Example: To obtain the number of rows in the matrix $\begin{bmatrix} 1 & 2 & 3 \\ 4 & 5 & 6 \end{bmatrix}$

Menu Item: [Action][Matrix-Calculation][rowDim]

$$\text{rowDim}(\begin{bmatrix} 1 & 2 & 3 \\ 4 & 5 & 6 \end{bmatrix})$$

$$2$$

- **rowNorm**

Function: Calculates the sums of the absolute values of the elements of each row of a matrix, and returns the maximum value of the sums.

Syntax: rowNorm (Mat [])

Example: To calculate the sums of the absolute values of the elements in each row of the matrix $\begin{bmatrix} 1 & -2 & 3 \\ 4 & -5 & -6 \end{bmatrix}$, and obtain the maximum value of the sums

Menu Item: [Action][Matrix-Calculation][rowNorm]

$$\text{rowNorm}(\begin{bmatrix} 1 & -2 & 3 \\ 4 & -5 & -6 \end{bmatrix})$$

$$15$$

- **colDim**

Function: Returns the number of columns in a matrix.

Syntax: colDim (Mat [])

Example: To obtain the number of columns in the matrix $\begin{bmatrix} 1 & 2 \\ 3 & 4 \\ 5 & 6 \end{bmatrix}$

Menu Item: [Action][Matrix-Calculation][colDim]

$$\text{colDim}(\begin{bmatrix} 1 & 2 \\ 3 & 4 \\ 5 & 6 \end{bmatrix})$$

$$2$$



- **colNorm**

Function: Calculates the sums of the absolute values of the elements of each column of a matrix, and returns the maximum value of the sums.

Syntax: colNorm (Mat [])

Example: To calculate the sums of the absolute values of the elements in each column of the matrix $\begin{bmatrix} 1 & -2 & 3 \\ 4 & -5 & -6 \\ -7 & 8 & 9 \end{bmatrix}$, and obtain the maximum value of the sums

Menu Item: [Action][Matrix-Calculation]
[colNorm]

```
colNorm([[1,-2,3][4,-5,-6][-7,8,9]])
18
```

Using the Vector Submenu

The [Vector] submenu contains commands that are related to vector calculations.

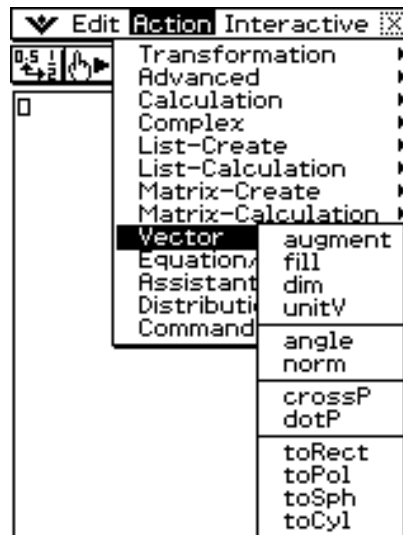

- A vector is handled as a $1 \times N$ matrix or $N \times 1$ matrix.
- A vector in the form of $1 \times N$ can be entered as [.....] or [[.....]].

Example: [1, 2], [[1, 2]]

- Vectors are considered to be in rectangular form unless $\angle()$ is used to indicate an angle measure.

- **augment**

Function: Returns an augmented vector [Mat-1 Mat-2].

Syntax: `augment (Mat-1, Mat-2 [])`

Example: To augment vectors [1, 2] and [3, 4]

Menu Item: [Action][Vector][augment]

```
augment([1,2],[3,4])
      [1 2 3 4]
```

- **fill**

Function: Creates a vector that contains a specific number of elements, or replaces the elements of a vector with a specific expression.

Syntax: `fill (Exp, Mat [])`

`fill (Exp, 1, number of columns [])`

Example: To replace the elements of the vector [1, 2] with x

Menu Item: [Action][Vector][fill]

```
fill(x,[1,2])
      [x x]
```

Example: To create a 1×3 (1 row, 3 columns) vector, all of whose elements are "3"

Menu Item: [Action][Vector][fill]

```
fill(3,1,3)
      [3 3 3]
```

- **dim**

Function: Returns the dimension of a vector.

Syntax: `dim (Mat [])`

Example: To determine the dimension of the vector [1, 2, 3]

Menu Item: [Action][Vector][dim]

```
dim([1,2,3])
      (1,3)
```

- The vector [1, 2, 3] is handled as a 1×3 matrix.

- **unitV**

Function: Normalizes a vector.

Syntax: `unitV (Mat [])`

- This command can be used with a $1 \times N$ or $N \times 1$ matrix only.

Example: To normalize the vector [1, 3, 5]

Menu Item: [Action][Vector][unitV]

```
unitV([1,3,5])
      [  sqrt(35)  3*sqrt(35)  sqrt(35) ]
      [   35       35       7       ]
```



- **angle**

Function: Returns the angle formed by two vectors.

Syntax: angle (Mat-1, Mat-2 [])

- This command can be used with a $1 \times N$ or $N \times 1$ matrix only.

Example: To determine the angle formed by vectors [1, 2] and [3, 4] (in the Radian mode)

Menu Item: [Action][Vector][angle]

$$\text{angle}([1,2],[3,4])$$

$$\cos^{-1}\left(\frac{11 \cdot \sqrt{5}}{25}\right)$$

- **norm**

Function: Returns the norm of a vector.

Syntax: norm (Mat [])

Example: To obtain the norm of the vector [1, 2, 3]

Menu Item: [Action][Vector][norm]

$$\text{norm}([1,2,3])$$

$$\sqrt{14}$$

- **crossP**

Function: Returns the cross product of two vectors.

Syntax: crossP (Mat-1, Mat-2 [])

- This command can be used with a $1 \times N$ or $N \times 1$ matrix only ($N = 2, 3$).
- A two-element matrix [a, b] or [[a], [b]] is automatically converted into a three-element matrix [a, b, 0] or [[a], [b], [0]].

Example: To obtain the cross product of the two vectors [1, 3, 5] and [2, 4, 6]

Menu Item: [Action][Vector][crossP]

$$\text{crossP}([1,3,5],[2,4,6])$$

$$[-2 \ 4 \ -2]$$

- **dotP**

Function: Returns the dot product of two vectors.

Syntax: dotP (Mat-1, Mat-2 [])

- This command can be used with a $1 \times N$ or $N \times 1$ matrix only.

Example: To obtain the dot product of the two vectors [1, 3, 5] and [2, 4, 6]

Menu Item: [Action][Vector][dotP]

$$\text{dotP}([1,3,5],[2,4,6])$$

$$44$$

• toRect

Function: Returns an equivalent rectangular form $[x\ y]$ or $[x\ y\ z]$.

Syntax: toRect (Mat [,natural number] [])

- This command can be used with a $1 \times N$ or $N \times 1$ matrix only ($N = 2, 3$).
- This command returns “x” when “natural number” is 1, “y” when “natural number” is 2, and “z” when “natural number” is 3.
- This command returns a rectangular form when you omit “natural number”.

Example: To transform the polar form $[\sqrt{2}, \angle(\pi/4)]$ into an equivalent rectangular form (in the Radian mode)

Menu Item: [Action][Vector][toRect]

$$\text{toRect}([\sqrt{2}, \angle(\pi/4)])$$

$$[1\ 1]$$

• toPol

Function: Returns an equivalent polar form $[r \angle \theta]$.

Syntax: toPol (Mat [,natural number] [])

- This command can be used with a 1×2 or 2×1 matrix only.
- This command returns “r” when “natural number” is 1, and “ θ ” when “natural number” is 2.
- This command returns a polar form when you omit “natural number”.

Example: To transform the rectangular form $[1, 2]$ into its equivalent polar form

Menu Item: [Action][Vector][toPol]

$$\text{toPol}([1, 2])$$

$$\left[\sqrt{5} \angle \left[-\tan^{-1}\left(\frac{1}{2}\right) + \frac{\pi}{2} \right] \right]$$

• toSph

Function: Returns an equivalent spherical form $[\rho \angle \theta \angle \phi]$.

Syntax: toSph (Mat [,natural number] [])

- This command can be used with a 1×3 or 3×1 matrix only.
- This command returns “ ρ ” when “natural number” is 1, “ θ ” when “natural number” is 2, and “ ϕ ” when “natural number” is 3.
- This command returns a spherical form when you omit “natural number”.

Example: To transform the rectangular form $[1, 1, 1]$ into its equivalent spherical form (in the Radian mode)

Menu Item: [Action][Vector][toSph]

$$\text{toSph}([1, 1, 1])$$

$$\left[\sqrt{3} \angle \left(\frac{\pi}{4} \right) \angle \left[\cos^{-1}\left(\frac{\sqrt{3}}{3}\right) \right] \right]$$

• toCyl

Function: Returns an equivalent cylindrical form $[r \angle \theta \ z]$.

Syntax: toCyl (Mat [,natural number] [])

- This command can be used with a 1×3 or 3×1 matrix only.
- This command returns “r” when “natural number” is 1, “ θ ” when “natural number” is 2, and “z” when “natural number” is 3.
- This command returns a cylindrical form when you omit “natural number”.

Example: To transform the rectangular form $[1, 1, 1]$ into an equivalent cylindrical form (in the Radian mode)

Menu Item: [Action][Vector][toCyl]

$$\text{toCyl}([1, 1, 1])$$

$$\left[\sqrt{2} \ \angle \left(\frac{\pi}{4} \right) \ 1 \right]$$

Using the Equation/Inequality Submenu

The [Equation/Inequality] submenu contains commands that are related to equations and inequalities.

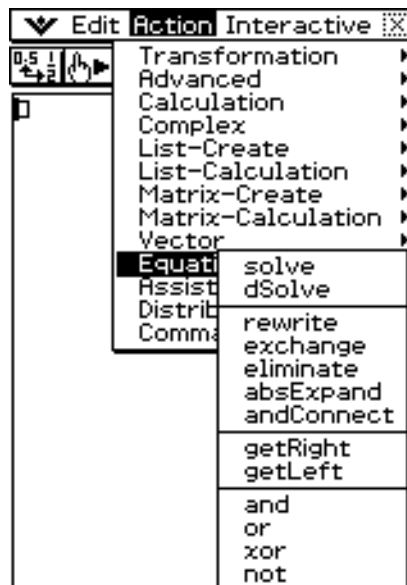

• solve

Function: Returns the solution of an equation or inequality.

Syntax: solve(Exp/Eq/Ineq [,variable] [])

- For this syntax, “Ineq” also includes the \neq operator.
- “x” is the default when you omit “[,variable]”.

solve(Exp/Eq,variable[, value, lower limit, upper limit] [])

- This syntax does not support “Ineq”, but the \neq operator is supported.
- “value” is an initially estimated value.
- This command is valid only for equations and \neq expressions when “value” and the items following it are included. In that case, this command returns an approximate value.
- A true value is returned when you omit “value” and the items following it. When, however, a true value cannot be obtained, an approximate value is returned for equations only based on the assumption that value = 0, lower limit = $-\infty$, and upper limit = ∞ .

solve({Exp-1/Eq-1, ..., Exp-N/Eq-N}, {variable-1, ..., variable-N} [])

- When “Exp” is the first argument, the equation $\text{Exp} = 0$ is presumed.

Example: To solve $ax + b = 0$ for x

Menu Item: [Action][Equation/Inequality][solve]

Calculator screen showing the input `solve(ax+b=0)` and the result $\left\{ x = \frac{-b}{a} \right\}$.

Example: To solve simultaneous linear equations $3x + 4y = 5$, $2x - 3y = -8$

Menu Item: [Action][Equation/Inequality][solve]

Calculator screen showing the input `solve((3x+4y=5, 2x-3y=-8), (x, y))` and the result $\{x=-1, y=2\}$.

You also could input the simultaneous equations shown in this example using the 2D keyboard key. The following shows the required input syntax.

$$\left\{ \begin{array}{l} \text{Exp-1/Eq-1} \\ \vdots \\ \text{Exp-N/Eq-N} \end{array} \right\} \text{variable-1, ..., variable-N}$$

- The following shows the required key operation to input this example using the key.

3 x + 4 y = 5 2 x - 3 y = -8 x, y 8

x y EXE

Calculator screen showing the input of simultaneous equations $\left\{ \begin{array}{l} 3x+4y=5 \\ 2x-3y=-8 \end{array} \right\} x, y$ and the result $\{x=-1, y=2\}$.

- To input simultaneous equations with three or more unknowns, press the key when the cursor is in the Exp-N/Eq-N input field. Each press of will add one more line for input of an equation.

Note

For the solution, the solve function returns an expression or value for the expression (Exp/Eq) input as its argument. The message “More solutions may exist” will appear on the display when a value is returned as the solution, because there may be multiple solutions.

The solve function can return a maximum of 10 solutions in the case of values.

Example: To solve $\cos(x) = 0.5$ for x (initial value: 0)

Menu Item: [Action][Equation/Inequality][solve]

```
solve(cos(x)=0.5,x,0)
{x=-780,x=-660,x=-420,x=-300,x=-60,x=60,x=300,x=420,x=660,x=780}
```

(Angle unit setting: Deg)

• dSolve

Function: Solves first, second or third order ordinary differential equations, or a system of first order differential equations.

Syntax: dSolve(Eq, independent variable, dependent variable [, initial condition-1, initial condition-2][, initial condition-3, initial condition-4][, initial condition-5, initial condition-6] [])

dSolve({Eq-1, Eq-2}, independent variable, {dependent variable-1, dependent variable-2} [, initial condition-1, initial condition-2, initial condition-3, initial condition-4] [])

- If you omit the initial conditions, the solution will include arbitrary constants.
- Input all initial conditions equations using the syntax Var = Exp. Any initial condition that uses any other syntax will be ignored.

Example: To solve a differential equation $y' = x$, where $y = 1$ when $x = 0$.

Menu Item: [Action][Equation/Inequality][dSolve]

```
dSolve(y'=x,x,y,x=0,y=1)
{y=x^2/2+1}
```

Example: To solve the system of first order differential equations $y' = y + z$, $z' = y - z$, where “ x ” is the independent variable, “ y ” and “ z ” are the dependent variables, and the initial conditions are $y = 3$ when $x = 0$, and $z = \sqrt{2} - 3$ when $x = 0$

Menu Item: [Action][Equation/Inequality][dSolve]

```
dSolve({y'=y+z,z'=y-z},x,{y,z},x=0,y=3,x=0,z=sqrt(2)-3)
{y=2*e^sqrt(2)*x+e^-sqrt(2)*x,z=-2*e^sqrt(2)*x-e^-sqrt(2)*x+2*sqrt(2)*e^sqrt(2)*x-sqrt(2)*e^-sqrt(2)*x}
```

• rewrite

Function: Moves the right side elements of an equation or inequality to the left side.

Syntax: rewrite(Eq/Ineq/List [])

- Ineq (inequality) includes the “ \neq ” (not equal to) relational operator.

Example: To move the right side elements of $x + 3 = 5x - x^2$ to the left side

Menu Item: [Action][Equation/Inequality][rewrite]

```
rewrite(x+3=5x-x^2)
x^2-4*x+3=0
```

• exchange

Function: Swaps the right-side and left-side elements of an equation or inequality.

Syntax: exchange(Eq/Ineq/List [])

- Ineq (inequality) includes the “ \neq ” (not equal to) relational operator.

Example: To swap the left-side and right-side elements of $3 > 5x - 2y$

Menu Item: [Action][Equation/Inequality][exchange]

```
exchange(3>5x-2y)
5·x-2·y<3
```

• eliminate

Function: Solves one equation with respect to a variable, and then replaces the same variable in another expression with the obtained result.

Syntax: eliminate(Eq/Ineq/List-1, variable, Eq-2 [])

- Ineq (inequality) includes the “ \neq ” (not equal to) relational operator.

Example: To transform $y = 2x + 3$ to $x =$, and substitute the result into $2x + 3y = 5$

Menu Item: [Action][Equation/Inequality][eliminate]

```
eliminate(2x+3y=5, x, y=2x+3)
4·y-3=5
```

• absExpand

Function: Divides an absolute value expression into formulas without absolute value.

Syntax: absExpand(Eq/Ineq [])

- Ineq (inequality) includes the “ \neq ” (not equal to) relational operator.

Example: To remove the absolute value from $|2x - 3| = 9$

Menu Item: [Action][Equation/Inequality][absExpand]

```
absExpand(|2x-3|=9)
2·x-3=9 or 2·x-3=-9
```

• andConnect

Function: Combines two equations or inequalities into a single expression.

Syntax: andConnect(Eq/Ineq-1, Eq/Ineq-2 [])

- Ineq (inequality) includes the “ \neq ” (not equal to) relational operator.

Example: To rewrite $x > -1$ and $x < 3$ into a single inequality

Menu Item: [Action][Equation/Inequality][andConnect]

```
andConnect(x>-1, x<3)
-1<x<3
```

• getRight

Function: Extracts the right-side elements of an equation or inequality.

Syntax: getRight(Eq/Ineq/List [])

- Ineq (inequality) includes the “ \neq ” (not equal to) relational operator.

Example: To extract the right side elements of $y = 2x^2 + 3x + 5$

Menu Item: [Action][Equation/Inequality][getRight]

```
getRight(y=2x^2+3x+5)
2·x^2+3·x+5
```

- **getLeft**

Function: Extracts the left-side elements of an equation or inequality.

Syntax: `getLeft(Eq/Ineq/List [])`

- Ineq (inequality) includes the “≠” (not equal to) relational operator.

Example: To extract the left side elements of $y = 2x^2 + 3x + 5$

Menu Item: [Action][Equation/Inequality][getLeft]

```
getLeft(y=2x^2+3x+5)
y
```

- **and**

Function: Returns the result of the logical AND of two expressions.

Syntax: `Exp/Eq/Ineq/List-1 and Exp/Eq/Ineq/List-2`

- Ineq (inequality) includes the “≠” (not equal to) relational operator.

Example: To obtain the result of the logical AND of $x^2 > 1$ and $x < 0$

Menu Item: [Action][Equation/Inequality][and]

```
x^2>1 and x<0
x<-1
```

- **or**

Function: Returns the result of the logical OR of two expressions.

Syntax: `Exp/Eq/Ineq/List-1 or Exp/Eq/Ineq/List-2`

- Ineq (inequality) includes the “≠” (not equal to) relational operator.

Example: To obtain the result of the logical OR of $x = 3$ or $x > 2$

Menu Item: [Action][Equation/Inequality][or]

```
x=3 or x>2
x>2
```

- **xor**

Function: Returns the logical exclusive OR of two expressions.

Syntax: `Exp/Eq/Ineq/List-1 xor Exp/Eq/Ineq/List-2`

- Ineq (inequality) includes the “≠” (not equal to) relational operator.

Example: To obtain the logical exclusive OR of $x < 2$ xor $x < 3$

Menu Item: [Action][Equation/Inequality][xor]

```
x<2 xor x<3
2≤x<3
```

- **not**

Function: Returns the logical NOT of an expression.

Syntax: `not(Exp/Eq/Ineq/List [])`

- Ineq (inequality) includes the “≠” (not equal to) relational operator.

Example: To obtain the logical NOT of $x = 1$

Menu Item: [Action][Equation/Inequality][not]

```
not(x=1)
x≠1
```



Using the Assistant Submenu

The [Assistant] submenu contains two commands related to the Assistant mode.

- Note that the following commands are valid in the Assistant mode only. For more information on the Assistant mode see “Assistant Mode and Algebra Mode” on page 2-2-8.



• arrange

Function: Collects like terms and arranges them in descending order, starting with the term that contains the smallest coefficient.

Syntax: `arrange (Exp/Eq/Ineq/List/Mat [])`

- Ineq (inequality) includes the “ \neq ” (not equal to) relational operator.

Example: To arrange $2x + 3 - 5x + 8y$ in the sequence of its variables

Menu Item: [Action][Assistant][arrange]

```
arrange(2x+3-5x+8y)
      -5·x+2·x+8·y+3
```

• replace

Function: Replaces the variable in an expression, equation or inequality with the value assigned to a variable using the “store” command.

Syntax: `replace (Exp/Eq/Ineq/List/Mat [])`

- Ineq (inequality) includes the “ \neq ” (not equal to) relational operator.

Example: To replace s in the expression $3x + 2s$, when the expression $2x + 1$ is assigned to s

Menu Item: [Action][Assistant][replace]

```
2x+1→s
      2·x+1
replace(3x+2s)
      3·x+2·(2·x+1)
```

• invert

Function: Inverts two variables in an expression.

Syntax: `invert (Exp/Eq/Ineq/List [,variable-1, variable-2] [])`

- Ineq (inequality) includes the “ \neq ” (not equal to) relational operator.

Example: To invert x and y in the expression $2x = y$

Menu Item: [Action][Transformation][invert]

```
invert(2x=y)
      2·y=x
```

- x and y are inverted when variables are not specified.

- **Clear_a_z**

Function: Clears all single-character variable names (a-z and A-Z) in the current folder.

clear_a_z done

Using the Distribution and Inv. Distribution Submenus

The [Distribution] and [Inv. Distribution] submenus include functions related to each type of statistical calculation distribution probability.

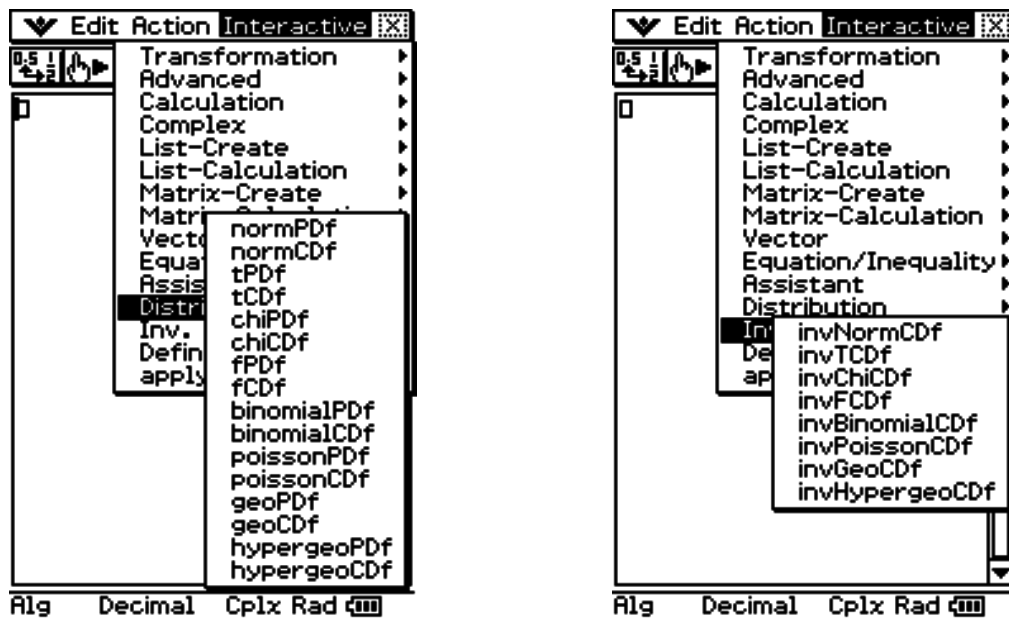

Note

The functions on the [Distribution] and [Inv. Distribution] submenus perform the same calculations as the Distribution commands that are available in the Statistics application and the Main, eActivity, and Program applications. For information about the numeric expressions used in calculations, the meanings of the variables used in the syntaxes of the functions presented in this section, and the system variables that store the values obtained as calculation results, see the “Distribution Command List” on pages 7-11-3 to 7-11-26.

Also see the “Distribution Command List” for information about how to use Distribution commands in the Statistics application and the required syntax when using Distribution commands within other applications.

Specifying Arguments within the Distribution Function

You can specify either values or list data for any of the arguments within the Distribution function. The normPDF function (page 2-8-49) syntax ($\text{normPDF}(x, \sigma, \mu)$) that returns normal probability density can be used to perform the calculations shown below. The “Number Format” setting is “Fix 2” for all calculation results.

$$\text{normPDF}(1, 1, 0) = 0.24$$

$$\text{normPDF}(\{1, 2\}, 1, 0) = \{0.24, 0.05\}$$

$$\text{normPDF}(1, \{1, 2\}, 0) = \{0.24, 0.18\}$$

$$\text{normPDF}(\{1, 2\}, \{1, 2\}, 0) = \{0.24, 0.12\}$$

$$\text{normPDF}(\{1, 2\}, \{1, 2\}, \{1, 0\}) = \{0.40, 0.12\}$$

The following explains how to specify list data in arguments and how calculation results are output.

(a) Specifying list data for a single argument

- Basically, you can specify any list you like, but the each of the elements in the list must be in accordance with the conditions required by the argument of the function being used.
- Calculation is performed on each element within the list and results are output as shown below.

$$\text{normPDF}(x, \{\sigma_1, \sigma_2\}, \mu)$$

$$= \{\langle \text{normPDF}(x, \sigma_1, \mu) \text{ calculation result} \rangle, \langle \text{normPDF}(x, \sigma_2, \mu) \text{ calculation result} \rangle\}$$

(b) Specifying list data for multiple arguments

- In this case, all of the lists must have the same number of elements. Otherwise an Invalid Dimension error will occur.
- Calculation is performed on each element within the list and results are output as shown below.

$$\text{normPDF}(\{x_1, x_2\}, \{\sigma_1, \sigma_2\}, \mu)$$

$$= \{\langle \text{normPDF}(x_1, \sigma_1, \mu) \text{ calculation results} \rangle, \langle \text{normPDF}(x_2, \sigma_2, \mu) \text{ calculation results} \rangle\}$$

Assignment of List Data Calculation Results to Variables

Using the list data in the argument of the Distribution function causes calculation results to be output as list data, which is assigned as-is to the “ans” variable.

In addition to the “ans” variable, calculations that use the Distribution function causes calculation results also to be assigned to certain system variables. For example, the normal probability density variable returned by normPDF is assigned to system variable *prob*. Only the last element of the list data will be assigned to a system variable as a calculation result. For information about which calculation result is assigned to which variable, see the “Calculation Result Output” item for each command in “7-11 Distributions” (pages 7-11-3 to 7-11-25).

• normPDF

Function: Returns the normal probability density for a specified value.

Syntax: $\text{normPDF}(x, \sigma, \mu)$

- When σ and μ are skipped, $\sigma = 1$ and $\mu = 0$ are used.

Example: To determine the normal probability density when $x = 37.5$, $\sigma = 2$, $\mu = 35$

Menu Item: [Action][Distribution][normPDF]

$\text{normPDF}(37.5, 2, 35)$ 0.09132454269
--

For more information, see “Normal Probability Density” on page 7-11-3.





• **normCDf**

Function: Returns the cumulative probability of a normal distribution between a lower bound and an upper bound.

Syntax: normCDf(lower value, upper value[, σ , μ])

- When σ and μ are skipped, $\sigma = 1$ and $\mu = 0$ are used.

Example: To determine the normal probability density when lower bound value = $-\infty$, upper bound value = 36, $\sigma = 2$, $\mu = 35$

Menu Item: [Action][Distribution][normCDf]

```
normCDf(-∞, 36, 2, 35)
0.6914624613
```

For more information, see “Normal Cumulative Distribution” on page 7-11-4.

• **invNormCDf**

Function: Returns the boundary value(s) of a normal cumulative distribution probability for specified values.

Syntax: invNormCDf([tail setting,]area value[, σ , μ])

- When σ and μ are skipped, $\sigma = 1$ and $\mu = 0$ are used.
- “tail setting” displays the probability value tail specification, and Left, Right, or Center can be specified. Enter the following values or letters to specify:

Left: -1, “L”, or “l”

Center: 0, “C”, or “c”

Right: 1, “R”, or “r”

When input is skipped, “Left” is used.

- When one argument is omitted (resulting in three arguments), Tail=Left.
- When two arguments are omitted (resulting in two arguments), Tail=Left, $\mu=0$.
- When three arguments are omitted (resulting in one argument), Tail=Left, $\sigma=1$, $\mu=0$.
- When “tail setting” is Center, the lower bound value is returned.

Example: To determine the upper bound value when tail setting = Left, area value = 0.7, $\sigma = 2$, $\mu = 35$

Menu Item: [Action][Inv. Distribution][invNormCDf]

```
invNormCDf("L", 0.7, 2, 35)
36.04880103
```

For more information, see “Inverse Normal Cumulative Distribution” on page 7-11-5.

• **tPDF**

Function: Returns the Student- t probability density for a specified value.

Syntax: tPDF(x , df [])

Example: To determine the Student- t probability density when $x = 2$, $df = 5$

Menu Item: [Action][Distribution][tPDF]

```
tPDF(2, 5)
0.06509031033
```

For more information, see “Student- t Probability Density” on page 7-11-6.



- **tCDf**

Function: Returns the cumulative probability of a Student- t distribution between a lower bound and an upper bound.

Syntax: `tCDf(lower value, upper value, df [])`

Example: To determine the Student- t distribution probability when lower value = 1.5, upper value = ∞ , $df = 18$

Menu Item: [Action][Distribution][tCDf]

```
tCDf(1.5, ∞, 18)
0.07547522609
```

For more information, see “Student- t Cumulative Distribution” on page 7-11-7.

- **invTCDf**

Function: Returns the lower bound value of a Student- t cumulative distribution probability for specified values.

Syntax: `invTCDf(prob, df [])`

Example: To determine the lower bound value when $prob = 0.0754752$, $df = 18$

Menu Item: [Action][Inv. Distribution][invTCDf]

```
invTCDf(0.0754752, 18)
1.500000203
```

For more information, see “Inverse Student- t Cumulative Distribution” on page 7-11-8.

- **chiPDF**

Function: Returns the χ^2 probability density for specified values.

Syntax: `chiPDF(x , df [])`

Example: To determine the χ^2 probability density when $x = 2$, $df = 4$

Menu Item: [Action][Distribution][chiPDF]

```
chiPDF(2, 4)
0.1839397206
```

For more information, see “ χ^2 Probability Density” on page 7-11-9.

- **chiCDf**

Function: Returns the cumulative probability of a χ^2 distribution between a lower bound and an upper bound.

Syntax: `chiCDf(lower value, upper value, df [])`

Example: To determine the χ^2 probability when lower value = 2.7, upper value = ∞ , $df = 4$

Menu Item: [Action][Distribution][chiCDf]

```
chiCDf(2.7, ∞, 4)
0.6092146125
```

For more information, see “ χ^2 Cumulative Distribution” on page 7-11-10.

- **invChiCDf**

Function: Returns the lower bound value of a χ^2 cumulative distribution probability for specified values.

Syntax: `invChiCDf(prob, df [])`

Example: To determine the lower bound value when $prob = 0.6092146$, $df = 4$

Menu Item: [Action][Inv. Distribution][invChiCDf]

```
invChiCDf(0.6092146, 4)
2.700000072
```

For more information, see “Inverse χ^2 Cumulative Distribution” on page 7-11-10.

- **fPDF**

Function: Returns the F probability density for a specified value.

Syntax: fPDF(x , $n:df$, $d:df$ [])

Example: To determine the F probability density when $x = 1.5$, $n:df = 24$, $d:df = 19$

Menu Item: [Action][Distribution][fPDF]

```
fPDF(1.5, 24, 19)
0.3951671524
```

For more information, see “ F Probability Density” on page 7-11-11.

- **fCDf**

Function: Returns the cumulative probability of an F distribution between a lower bound and an upper bound.

Syntax: fCDf(lower value, upper value, $n:df$, $d:df$ [])

Example: To determine the F distribution probability when lower value = 1.5, upper value = ∞ , $n:df = 24$, $d:df = 19$

Menu Item: [Action][Distribution][fCDf]

```
fCDf(1.5, ∞, 24, 19)
0.185196483
```

For more information, see “ F Cumulative Distribution” on page 7-11-12.

- **invFCDf**

Function: Returns the lower bound value of an F cumulative distribution probability for specified values.

Syntax: invFCDf($prob$, $n:df$, $d:df$ [])

Example: To determine the lower bound value when $prob = 0.1852$, $n:df = 24$, $d:df = 19$

Menu Item: [Action][Inv. Distribution][invFCDf]

```
invFCDf(0.1852, 24, 19)
1.4999911
```

For more information, see “Inverse F Cumulative Distribution” on page 7-11-13.

- **binomialPDF**

Function: Returns the probability in a binomial distribution that the success will occur on a specified trial.

Syntax: binomialPDF(x , numtrial value, pos [])

Example: To determine the binomial probability when $x = 5$, numtrial value = 3, $pos = 0.63$

Menu Item: [Action][Distribution][binomialPDF]

```
binomialPDF(5, 3, 0.63)
0
```

For more information, see “Binomial Distribution Probability” on page 7-11-14.

• binomialCdf

Function: Returns the cumulative probability in a binomial distribution that the success will occur between specified lower value and upper value.

Syntax: binomialCdf(lower value, upper value, numtrial value, *pos* [])

Example: To determine the binomial cumulative probability when lower value = 2, upper value = 5, numtrial value = 3, *pos* = 0.63

Menu Item: [Action][Distribution][binomialCdf]

```
binomialCdf(2,5,3,0.63)
0.690606
```

For more information, see “Binomial Cumulative Distribution” on page 7-11-15.

• invBinomialCdf

Function: Returns the minimum number of trials of a binomial cumulative probability distribution for specified values.

Syntax: invBinomialCdf(*prob*, numtrial value, *pos* [])

Important!

When executing the invBinomialCdf function the calculator uses the specified *prob* value and the value that is one less the *prob* value minimum number of significant digits (**prob* value) to calculate minimum number of trials values. The results are assigned to the system variables *xInv* (calculation result using *prob*) and **xInv* (calculation result using **prob*). The invBinomialCdf function always returns the *xInv* value only. However, when the *xInv* and **xInv* values are different, the warning message shown below appears showing both values.

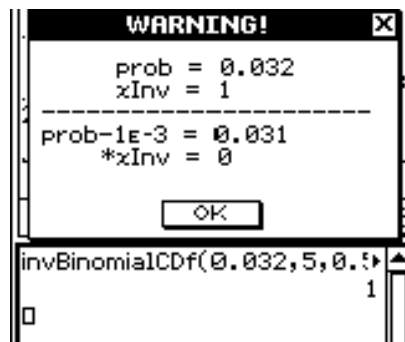

The calculation results of invBinomialCdf are integers. Accuracy may be reduced when the first argument has 10 or more digits. Note that even a slight difference in calculation accuracy affects calculation results. If a warning message appears, check the displayed values.

Example: To determine the minimum number of trials when *prob* = 0.609, numtrial value = 5, *pos* = 0.63

Menu Item: [Action][Inv. Distribution][invBinomialCdf]

```
invBinomialCdf(0.609,5,0.63)
3
```

For more information, see “Inverse Binomial Cumulative Distribution” on page 7-11-16.

- **poissonPDF**

Function: Returns the probability in a Poisson distribution that the success will occur on a specified trial.

Syntax: poissonPDF(x, λ [])

Example: To determine the Poisson probability when $x = 10, \lambda = 6$

Menu Item: [Action][Distribution][poissonPDF]

```
poissonPDF(10,6)
0.04130309341
```

For more information, see “Poisson Distribution Probability” on page 7-11-17.

- **poissonCDf**

Function: Returns the cumulative probability in a Poisson distribution that the success will occur between specified lower value and upper value.

Syntax: poissonCDf(lower value, upper value, λ [])

Example: To determine the Poisson cumulative probability when lower value = 2, upper value = 3, $\lambda = 2.26$

Menu Item: [Action][Distribution][poissonCDf]

```
poissonCDf(2,3,2.26)
0.4672462698
```

For more information, see “Poisson Cumulative Distribution” on page 7-11-18.

- **invPoissonCDf**

Function: Returns the minimum number of trials of a Poisson cumulative probability distribution for specified values.

Syntax: invPoissonCDf($prob, \lambda$ [])

Important!

When executing the invPoissonCDf function the calculator uses the specified *prob* value and the value that is one less the *prob* value minimum number of significant digits (**prob* value) to calculate minimum number of trials values. The results are assigned to the system variables *xInv* (calculation result using *prob*) and **xInv* (calculation result using **prob*). The invPoissonCDf function always returns the *xInv* value only. However, when the *xInv* and **xInv* values are different, the warning message shown below appears showing both values.

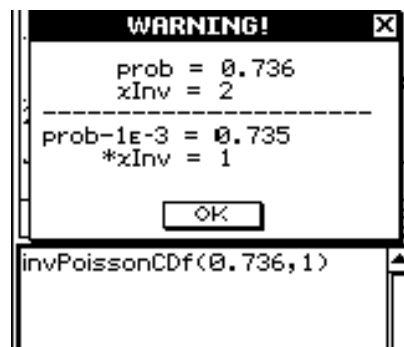

The calculation results of invPoissonCDf are integers. Accuracy may be reduced when the first argument has 10 or more digits. Note that even a slight difference in calculation accuracy affects calculation results. If a warning message appears, check the displayed values.

Example: To determine the minimum number of trials when $prob = 0.8074$, $\lambda = 2.26$

Menu Item: [Action][Inv. Distribution][invPoissonCdf] 

For more information, see “Inverse Poisson Cumulative Distribution” on page 7-11-19.

• geoPDf

Function: Returns the probability in a geometric distribution that the success will occur on a specified trial.

Syntax: geoPDf(x , pos [])

Example: To determine the geometric probability when $x = 6$, $pos = 0.4$

Menu Item: [Action][Distribution][geoPDf] 

For more information, see “Geometric Distribution Probability” on page 7-11-20.

• geoCDf

Function: Returns the cumulative probability in a geometric distribution that the success will occur between specified lower value and upper value.

Syntax: geoCDf(lower value, upper value, pos [])

Example: To determine the geometric probability when lower value = 2, upper value = 3, $pos = 0.5$

Menu Item: [Action][Distribution][geoCDf] 

For more information, see “Geometric Cumulative Distribution” on page 7-11-21.

• invGeoCDf

Function: Returns the minimum number of trials of a geometric cumulative probability distribution for specified values.

Syntax: invGeoCDf($prob$, pos [])

Important!

When executing the invGeoCDf function the calculator uses the specified $prob$ value and the value that is one less the $prob$ value minimum number of significant digits ($*prob$ value) to calculate minimum number of trials values. The results are assigned to the system variables $xInv$ (calculation result using $prob$) and $*xInv$ (calculation result using $*prob$). The invGeoCDf function always returns the $xInv$ value only. However, when the $xInv$ and $*xInv$ values are different, the warning message shown below appears showing both values.

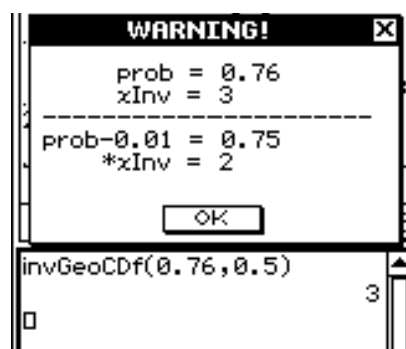

The calculation results of `invGeoCDf` are integers. Accuracy may be reduced when the first argument has 10 or more digits. Note that even a slight difference in calculation accuracy affects calculation results. If a warning message appears, check the displayed values.

Example: To determine the minimum number of trials when $prob = 0.875$, $pos = 0.5$

Menu Item: [Action][Inv. Distribution][invGeoCDf]

invGeoCDf(0.875,0.5)	3
----------------------	---

For more information, see “Inverse Geometric Cumulative Distribution” on page 7-11-22.

• hypergeoPDf

Function: Returns the probability in a hypergeometric distribution that the success will occur on a specified trial.

Syntax: `hypergeoPDf(x, n, M, N [])`

Example: Determine the hypergeometric probability when $x = 1$, $n = 5$, $M = 10$, $N = 20$.

Menu Item: [Action][Distribution][hypergeoPDf]

hypergeoPDf(1,5,10,20)	0.1354489164
------------------------	--------------

For more information, see “Hypergeometric Distribution Probability” on page 7-11-23.

• hypergeoCDf

Function: Returns the cumulative probability in a hypergeometric distribution that the success will occur between specified lower value and upper value.

Syntax: `hypergeoCDf(lower value, upper value, n, M, N [])`

Example: Determine the hypergeometric cumulative distribution when lower value = 0, upper value = 1, $n = 5$, $M = 10$, $N = 20$.

Menu Item: [Action][Distribution][hypergeoCDf]

hypergeoCDf(0,1,5,10,20)	0.1517027864
--------------------------	--------------

For more information, see “Hypergeometric Cumulative Distribution” on page 7-11-24.

• invHypergeoCDf

Function: Returns the minimum number of trials of a hypergeometric cumulative distribution for specified values.

Syntax: `invHypergeoCDf(prob, n, M, N [])`

Important!

When executing the `invHypergeoCDf` function the calculator uses the specified *prob* value and the value that is one less the *prob* value minimum number of significant digits (**prob* value) to calculate minimum number of trials values. The results are assigned to the system variables *xInv* (calculation result using *prob*) and **xInv* (calculation result using **prob*). The `invHypergeoCDf` function always returns the *xInv* value only. However, when the *xInv* and **xInv* values are different, the warning message shown below appears showing both values.



The calculation results of `invHypergeoCDF` are integers. Accuracy may be reduced when the first argument has 10 or more digits. Note that even a slight difference in calculation accuracy affects calculation results. If a warning message appears, check the displayed values.

Example: To determine the minimum number of trials when $prob = 0.3$, $n = 5$, $M = 10$, $N = 20$

Menu Item: [Action][Inv. Distribution][invHypergeoCDF]

```
invHypergeoCDF(0.3,5,10,
2
```

For more information, see “Inverse Hypergeometric Cumulative Distribution” on page 7-11-25.

Using the Command Submenu

- **Define**

Function: Creates a user-defined function.

For more information, see “Define” on page 12-6-9 and “Creating a User-defined Function Using the Define Command” on page 12-5-2.

- **DispStat**

Function: Displays previous statistical calculation results.

For more information, see “DispStat” on page 12-6-28 and “To explore statistical data” on page 12-7-5.

- **Clear_a_z**

Function: Clears all single-character variables.

For more information, see “Clear_a_z” on page 2-8-48.

- **DelVar**

Function: Deletes a specified variable.

For more information, see “DelVar” on page 12-6-39.

- **Clear All Variables**

Function: Clear variables that contain numbers, list and matrices.

2-9 Using the Interactive Menu

The [Interactive] menu includes most of the commands that are on the [Action] menu. Selecting a command on the [Action] menu will simply execute the command. With the [Interactive] menu, on the other hand, selecting a command will display a dialog box prompting input of the arguments required by the command's syntax (when necessary). The following are the differences between the [Interactive] menu and [Action] menu.

Interactive Menu and Action Menu

- With the [Action] menu, you select a command to input a function into the work area.
- With the [Interactive] menu, you drag the stylus across existing input in the work area and then select a command. This encloses the highlighted expression with the command and opens a dialog box if more arguments are needed.
- When you select an [Interactive] menu item without highlighting an expression first, a dialog box will open prompting you for the necessary arguments.
- When a command requires multiple arguments, a dialog box appears prompting you for the arguments with the [Interactive] menu.
- The [Interactive] menu has an “apply” command while the [Action] menu does not.
- The “DispStat”, “Clear_a_z,” and “DelVar” commands of the [Action] menu's [Command] submenu are not included on the [Interactive] menu.

Tip

- Operation of the following [Interactive] menu commands is identical to the same commands on the [Action] menu.
[Transformation], [Advanced], [Calculation], [Complex], [List-Create], [List-Calculation], [Matrix-Create], [Matrix-Calculation], [Vector], [Equation/Inequality], [Assistant], Define
- For information about using these commands, see “2-8 Using the Action Menu”.

Interactive Menu Example

The following example shows how to use the [Transformation]-[factor] command from both the [Interactive] menu and the [Action] menu.

Example: To factorize the expression $x^3 - 3x^2 + 3x - 1$

• To factorize from the Interactive menu

- (1) In the work area, input the expression you want to factorize ($x^3 - 3x^2 + 3x - 1$).
- (2) Drag the stylus across the expression to select it.



- (3) Tap [Interactive], [Transformation], and then [factor].
 - This factorizes the selected expression.



• To factorize from the Action menu

(1) Tap [Action], [Transformation], and then [factor].

- This inputs “factor(” into the work area.



(2) Input the expression you want to factorize

$$(x^3 - 3x^2 + 3x - 1).$$



(3) Tap [EXE].

- This factorizes the selected expression.

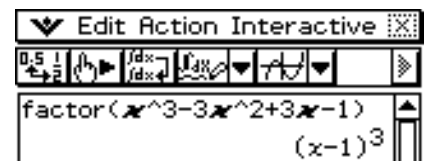

- Though the above two procedures are quite different, they both produce the same result.

[Interactive] menu operations come in handy in the following cases.

- When you want to use a command on an expression you are calculating
- When you want to use a command that requires multiple arguments

When you use the [Interactive] menu to access a command that requires multiple arguments or if you access a command without first highlighting an expression, the dialog box that appears shows the number of arguments, the contents of each argument, and the input sequence. This lets you perform your input without worrying about command syntax.

The following procedure shows an example of using the [Interactive] menu when three arguments need to be specified.

Example: To obtain the definite integral of $x^2 + 2x$, $1 \leq x \leq 2$

• ClassPad Operation

(1) In the work area, input the expression $(x^2 + 2x)$.

(2) Drag the stylus across the expression to select it.



(3) Tap [Interactive], [Calculation], and then [∫].

- This displays the ∫ dialog box.

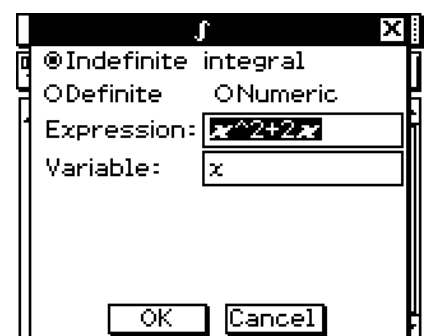

(4) On the dialog box, tap “Definite integral” to select it.

- This displays boxes for specifying the variable and the lower limit and the upper limit.

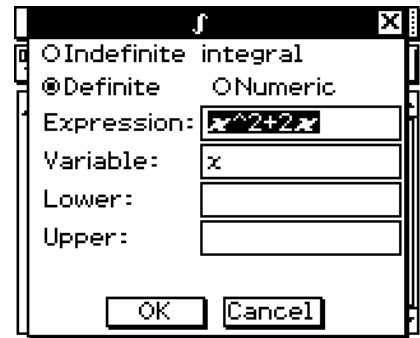

(5) Input the required data for each of the following three arguments.

Variable: x

Lower: 1

Upper: 2

(6) Tap [OK].

- This performs the calculation and displays the solution.

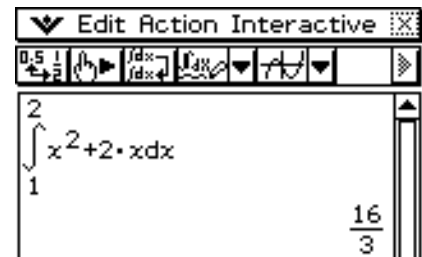

Tip

- You can execute a command on the Interactive menu without selecting an expression in the work area. On the dialog box that appears, enter the expression you can to perform into the “Expression” box.

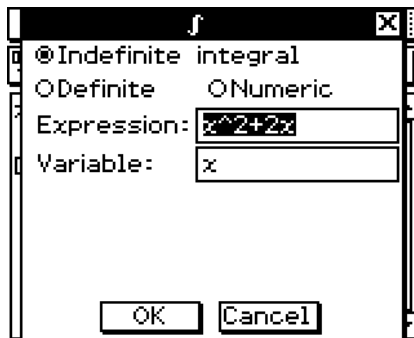

Dialog box when an expression is selected in the work area when you tap [Interactive] - [Calculation] - [∫].

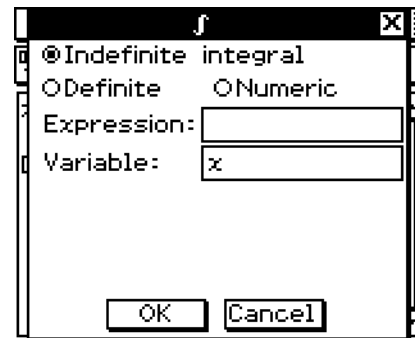

Dialog box when no expression is selected.

Using the “apply” Command

The “apply” command is included on the [Interactive] menu only. You can use this command to execute only a specific part of an expression and display its result.

Example: To calculate the result of $\text{diff}(\sin(x),x) \times \cos(x) + \sin(x) \times \text{diff}(\cos(x),x)$, and then calculate only part of the expression

Note

- This procedure assumes that your ClassPad is configured with the following mode settings: Algebra, Complex, Radian, Descending Order.

• ClassPad Operation

(1) Input the example calculation provided above and execute it.

- For details about differential calculations, see “2-8 Using the Action Menu”.

$$\left. \begin{array}{l} \text{diff}(\sin(x),x) \times \cos(x) + \sin(x) \times \text{diff}(\cos(x),x) \\ (\cos(x))^2 - (\sin(x))^2 \end{array} \right\}$$

(2) Drag the stylus across “diff(sin(x),x)” to select it.

$$\left. \begin{array}{l} \text{diff}(\sin(x),x) \times \cos(x) + \sin(x) \times \text{diff}(\cos(x),x) \\ (\cos(x))^2 - (\sin(x))^2 \end{array} \right\}$$

(3) Tap [Interactive] and then [apply].

- This executes the part of the calculation you selected in step (2). The part of the calculation that is not selected ($\times \cos(x) + \sin(x) \times \text{diff}(\cos(x),x)$) is output to the display as-is.

$$\left. \begin{array}{l} \text{apply}(\text{diff}(\sin(x),x)) \times \cos(x) + \sin(x) \times \text{diff}(\cos(x),x) \\ \cos(x) \cdot \cos(x) + \sin(x) \cdot \frac{d}{dx} \cos(x) \end{array} \right\}$$



2-10 Using the Main Application in Combination with Other Applications

You can access the windows of other ClassPad applications from the Main application and perform copy, paste, and other operations between them.

This section explains how to access the windows of other applications from the Main application, and provides examples of the various operations you can perform between them.

Important!

- For details about the windows produced by each ClassPad application, see the chapter that covers the application. All of the explanations in this section assume that you are already familiar with the operations in the other ClassPad applications.

Opening Another Application's Window

Use the following procedure to access the window of another application from the Main application window.

• ClassPad Operation

(1) Tap the right most toolbar down arrow button.

- This displays a palette of application icons.

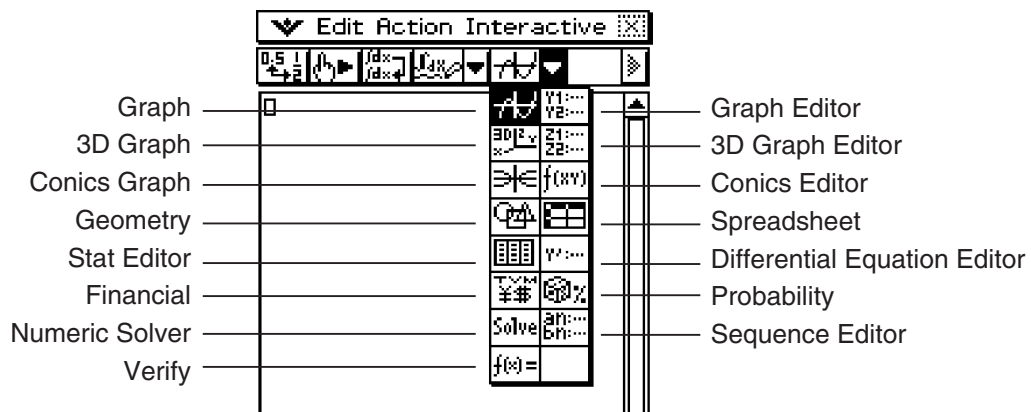

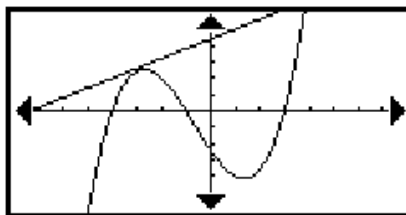

(2) Tap the button that corresponds to the window you want to display.

- This causes the window that corresponds to the button you tap to appear in the lower window.







Closing Another Application's Window

• ClassPad Operation

- (1) Tap anywhere inside of the window you would like to close.
- (2) Tap the  button in the upper right corner, or tap  and then [Close].
 - The Main application work area expands to fill the entire display.

Tip

- Even if you used the icon panel  icon to expand the lower window to fill the entire display, tapping  and then [Close] closes it and returns to the work area window.
- Nothing happens if you tap  and then [Close] while the work area window is active.
- For more information about enlarging one of the windows on a dual window display to fill the entire display ()^{Resize}, swapping the contents of the upper window and lower window ()^{Swap}, making a window active, and other window operations, see “Using a Dual Window Display” on page 1-5-1.



Using the Graph Window and 3D Graph Window

Dragging a function from the work area to the Graph window  graphs it in the format of $y = f(x)$.

Dragging a function from the work area to the 3D Graph window  graphs it in the format of $z = f(x, y)$.

Example: To execute the expression $\text{factor}(x^2 - 1)$ in the work area, and then graph $x^2 - 1$

• ClassPad Operation

- (1) Input “factor ($x^2 - 1$)” into the work area, and then tap .
- (2) Tap  to display the Graph window in the lower window.

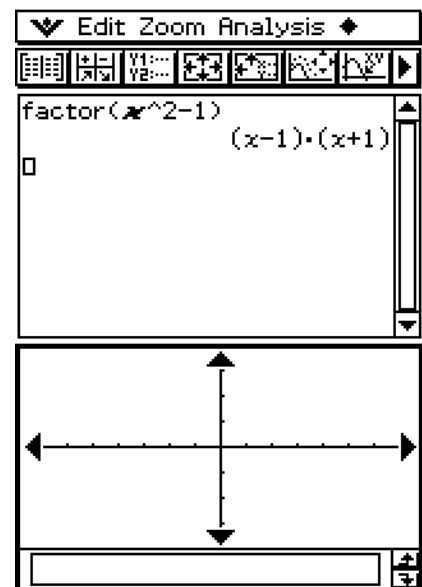

- (3) Drag the stylus across " $x^2 - 1$ " in the work area to select it.

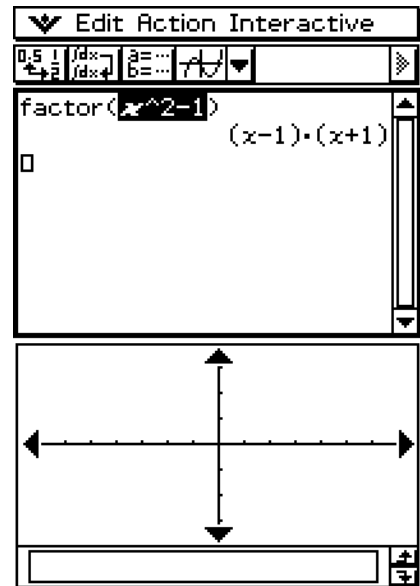

- (4) Drag the selected expression to the Graph window.
- This graphs $y = x^2 - 1$. This graph reveals that the x -intercepts are $x = \pm 1$.

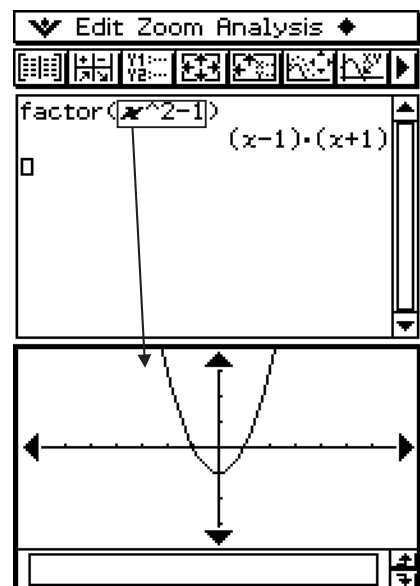

Tip

- As can be seen in the above example, a graph can be drawn when you drop an expression in the form of $f(x)$ into the Graph window. In the case of the 3D Graph window, the expression must be in the form of $f(x,y)$.
- For more information about the Graph window, see Chapter 3. For more information about the 3D Graph window, see Chapter 5.

Using a Graph Editor Window (Graph & Table: , Conics: , 3D Graph: , Numeric Solver:)

You can copy expressions by dragging them between the work area window and the Graph Editor, Conics Editor, 3D Graph Editor, and Numeric Solver windows.

Example: To copy an expression in the work area by dragging it to the Graph Editor window

• ClassPad Operation

- (1) On the work area window, tap  to display the Graph Editor window in the lower window.
 - If you already have some functions input in the Graph & Table application, those functions will be displayed on the Graph Editor window.
- (2) In the work area, drag the stylus across the expression you want to copy so it is selected.

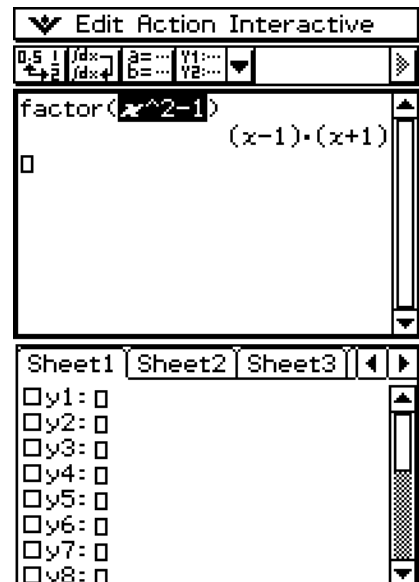

- (3) Drag the selected expression to the location on the Graph Editor window where you want to copy it.
 - This makes the Graph Editor window active and copies the expression to the location where you dropped it.

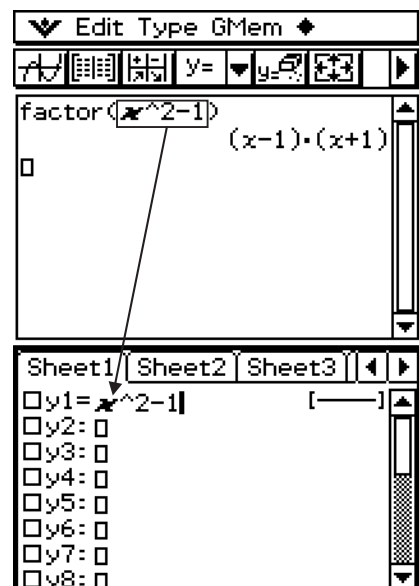

(4) Press EXE to register the expression.

- The copied expression is displayed in natural format, with the check box next to it selected.
- You could now tap G to graph the function.

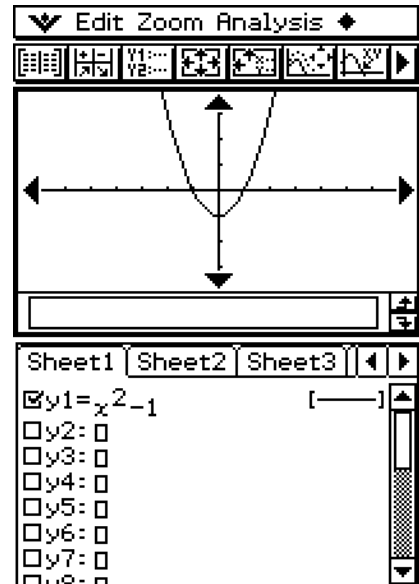

Tip

- For more information about the Graph Editor window, see Chapter 3. For more information about the Conics Graph Editor window, see Chapter 4. For more information about the 3D Graph Editor window, see Chapter 5. For more information about the Numeric Solver window, see Chapter 9.

Using the Stat Editor Window SE

You can use the Stat Editor window to create new LIST variables and edit existing LIST variables. You can also use the Stat Editor window to display the contents of a LIST variable created using the work area by specifying the LIST variable's name.

■ Example List Operation

The following are the general steps for using the Stat Editor. The steps indicated in parentheses refer to the steps under "ClassPad Operation" below.

1. Display the Stat Editor (step (1)) and input data for two LIST variables named "list1" and "list2" (step (2)).
2. On the work area window, perform calculations that use "list1" and "list2" (steps (3) and (4)).
3. Use the work area to assign numbers to a variable and create a new LIST variable (steps (5) and (6)).
4. Display the Stat Editor window and recall the LIST variable you created (steps (7), (8) and (9)).

• ClassPad Operation

(1) On the work area window, tap  to display the Stat Editor window in the lower window.

(2) Input the following list data into the lists named "list1" and "list2". list1 = {1, 2, 3} list2 = {4, 5, 6}

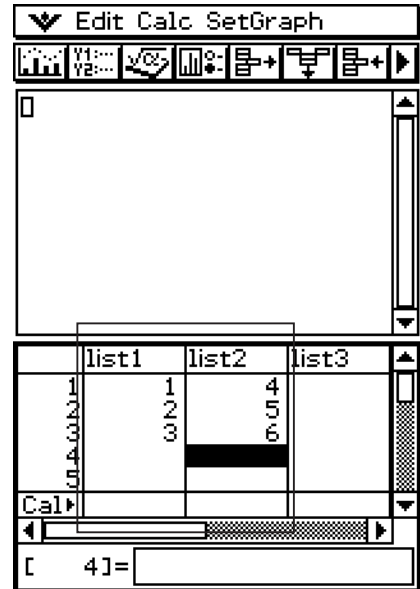

(3) Make the work area window active, and then perform the following calculation: list1 + list2 \Rightarrow list3.

- You could also input "list3:=list1+list2" to produce the same result.



(4) Tap the Stat Editor window to make it active.

- Here you can see that list3 contains the result of list1 + list2.

The screenshot shows the 'Edit Calc SetGraph' window. The main area displays the operation `list1+list2⇒list3` with the result `(5,7,9)`. Below this is a table with three columns: list1, list2, and list3. The data is as follows:

	list1	list2	list3
1	1	4	5
2	2	5	7
3	3	6	9
4			
5			

At the bottom, there is a 'Cal' menu and a calculator input field showing `[4] =`.

(5) Tap the work area window to make it active.

(6) Perform the operation `{12, 24, 36}⇒test`, which assigns the list data `{12, 24, 36}` to the LIST variable named "test".

The screenshot shows the 'Edit Action Interactive' window. The main area displays the operation `list1+list2⇒list3` with the result `(5,7,9)`. Below this, the operation `{12,24,36}⇒test` is shown with the result `(12,24,36)`.

- (7) Tap the Stat Editor window to make it active.
 (8) Scroll the screen to the right until the blank list to the right of “list6” is visible.

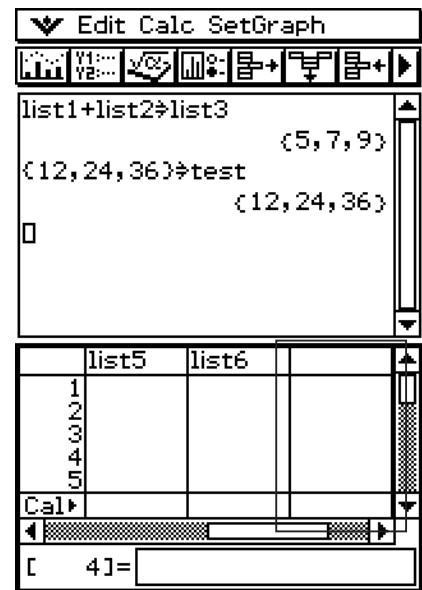

- (9) Tap the blank cell next to “list6”, input “test”, and then tap **EXE**.

- This displays the list data {12, 24, 36}, which is assigned to the variable named “test”.
- At this point you can perform list editing operations like append, delete, edit, etc.

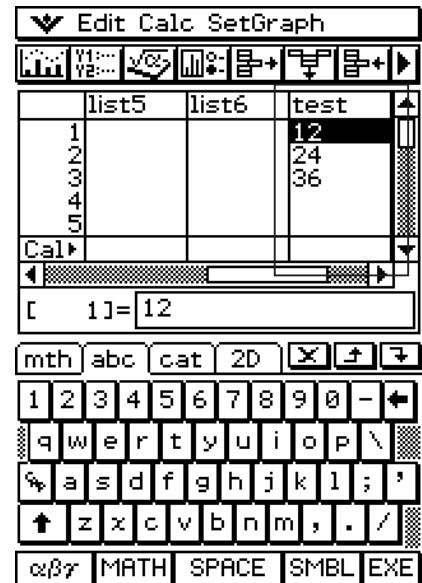

Tip

- list1 through list6 are LIST type system variables. For more information, see “1-7 Variables and Folders”.
- For information about inputting and editing list data using the Stat Editor, see Chapter 7.

Using the Geometry Window

When there is a Geometry window on the display, you can drag values and expressions to the Geometry window to draw the graph or figure of the value or expression. You can also drag a figure from the Geometry window to the work area, which displays the corresponding expression or value.

■ Dragging an Expression from the Work Area to the Geometry Window

Example: To input the expressions $x^2/5^2 + y^2/2^2 = 1$ and $x^2 + y^2 = 1$ in the work area, and then drag them to the Geometry window

• ClassPad Operation

- (1) Input the two expressions into the work area.
- (2) Tap  to display the Geometry window in the lower window.
 - The Geometry window that initially appears is blank.
- (3) Drag the stylus across $x^2/5^2 + y^2/2^2 = 1$ in the work area to select it.

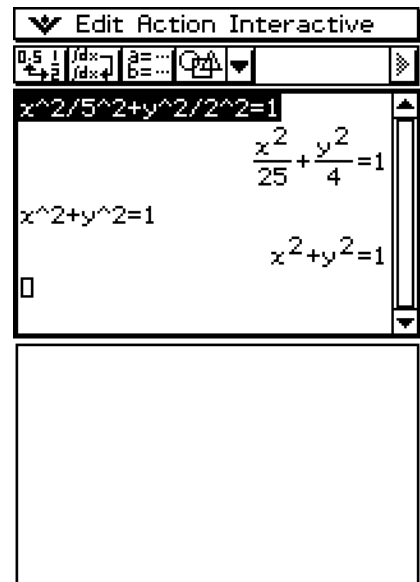

- (4) Drag the selected expression to the Geometry window.
 - An ellipse appears in the Geometry window.

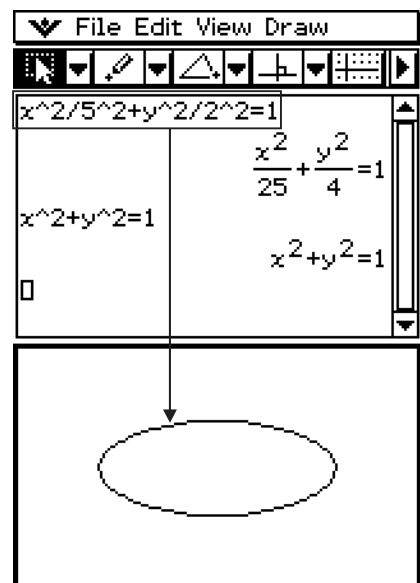

(5) Drag the stylus across $x^2 + y^2 = 1$ in the work area to select it.

(6) Drag the selected expression to the Geometry window.

- A circle appears in the Geometry window.

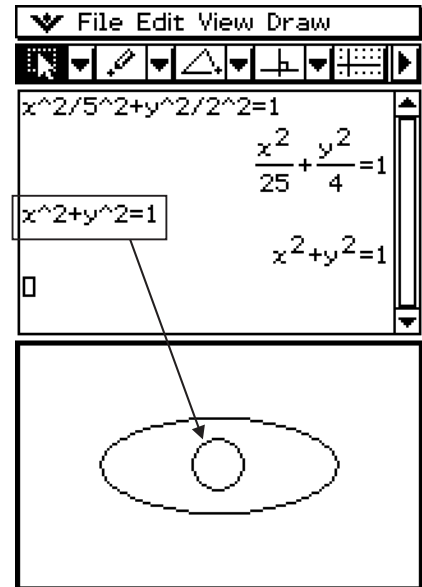

Tip

- The following table shows the types of expressions you can drop into the Geometry window.

Dropping this into the Geometry window:	Displays this:
Linear equation in x and y	An infinite line
Equation of circle in x and y	A circle
Equation of ellipse in x and y	An ellipse
Equation of hyperbola in x and y	A hyperbola
2-dimensional vector (2 rows \times 1 column format)	A point
Equation $y = f(x)$	A curve
$2 \times n$ matrix, $n \geq 3$	A polygon (each column represents a vertex of the polygon)
$n \times 2$ matrix, $n \geq 3$	An open polygon

- When the expression is not recognized, Geometry displays it as text.

■ Dragging a Figure from the Geometry Window to the Work Area

The following shows what happens when you drag a figure from the Geometry window to the work area.

Dropping this into the work area:	Displays this:
Point	Coordinates as a vector (2×1 matrix)
Line	Equation of the line
Vector	An ordered pair (head of vector assuming the tail is at the origin)
Circle, Arc, Ellipse, Function, or Curve	Corresponding equation
Polygon	$2 \times n$ matrix
Open Polygon (Created by Animation)	$n \times 2$ matrix
Line Pair	Simultaneous equations for the pair
A point and its image under a transformation	Matrix expression for the transformation

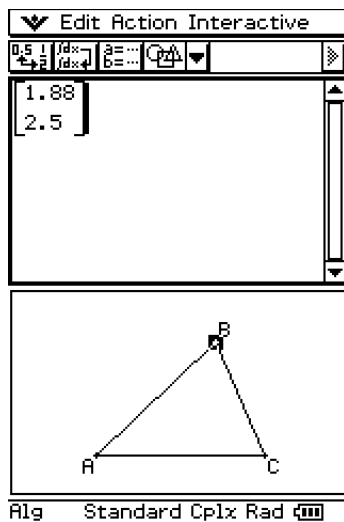

Point

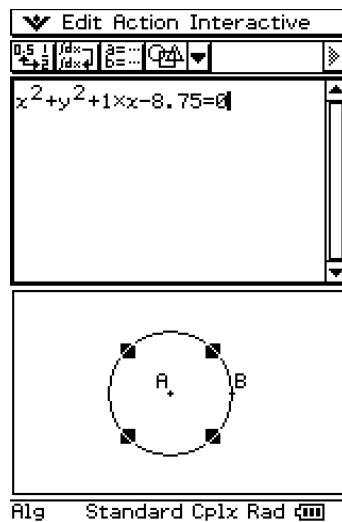

Circle

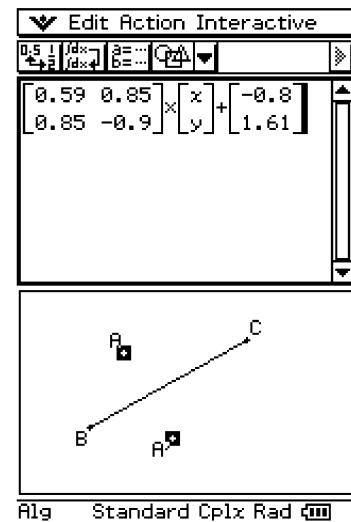

A point and its image

Tip

- For details about Geometry window operations, see Chapter 8.

Using the Sequence Editor Window

Displaying the Sequence Editor window from the Main application makes it possible for you to perform the same operations you can perform in the Sequence application. You can also use drag and drop to copy expressions between the work area and the Sequence Editor window.

Tip

- For information about Sequence Editor operations and other Sequence application operations, see Chapter 6.

2-11 Using Verify

Verify provides you with a powerful tool to check whether your numeric or algebraic manipulations are correct. Verify will assist you in simplifying an expression by verifying whether or not the expression you entered is equivalent to your original expression. If it is, you will get a pleasant response; if not, you will need to correct your mistake before continuing.

You can access Verify within the Main application or the eActivity application. In the Main application, you can save Verify sessions in ClassPad memory and reopen the session for future use.

Verify sessions can also be saved within an eActivity. For more information on saving an eActivity, see “10-2 Creating an eActivity”.

Important!

- Most Verify operations are the same in both the Main application and the eActivity application.

Starting Up Verify

Use the following procedure to start up Verify.

• ClassPad Operation

- (1) Tap the right most toolbar down arrow button.
- (2) On the icon palette that appears, tap $f(x)=$.

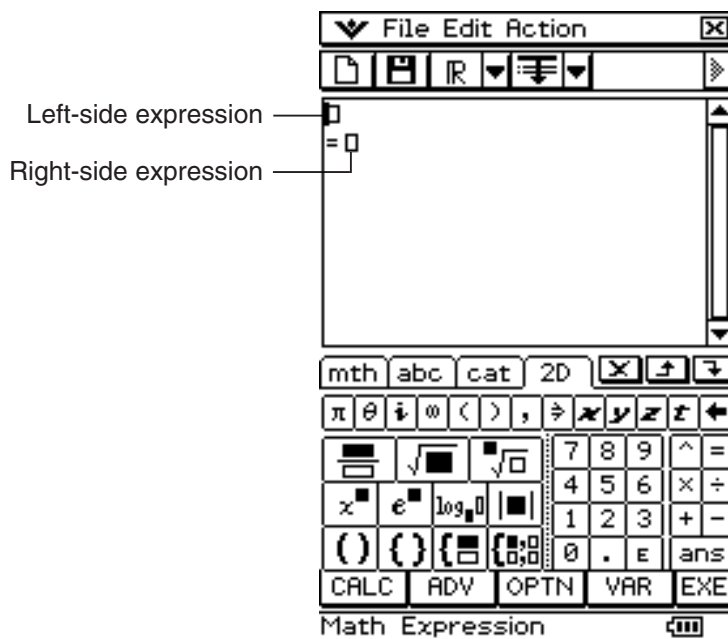





Verify Menus and Buttons

This section provides basic information about Verify menus, commands, and buttons.

Tip

-  menu items are the same for all applications. For more information, see “Using the  Menu” on page 1-5-4.

■ File Menu

To do this:	Select this File menu item:
Discard the current window contents and create a new file	New
Open an existing file	Open
Save the current window contents to a file	Save

■ Edit Menu

To do this:	Select this Edit menu item:
Undo the last operation or redo an operation that was just undone	Undo/Redo
Cut the currently selected object and place it onto the clipboard	Cut
Copy the currently selected object and place it onto the clipboard	Copy
Paste the current clipboard contents onto the screen	Paste
Select the entire row where the cursor is located	Select All
Delete the entire row where the cursor is located	Delete
Clear the Verify window	Clear All







■ Action Menu

For information about Action menu commands, see “2-8 Using the Action Menu”.

Important!

Some Action menu commands are not useful in Verify, but for ease of use Verify’s Action menu is identical to the Action menus in the Main application and the eActivity application.

■ Verify Buttons

To do this:	Tap this Verify button:
Clear the Verify window (same as the Clear All command)	
Open or save a file (Main application only)	
Specify the complex number calculation range for Verify	
Specify the real number calculation range for Verify	
Specify the positive real number calculation range for Verify	
Verify the equation starting from the first line	
Verify the equation starting from the current line	

Using Verify

The following examples show the basic steps for using Verify.

Important!

- In Verify, you can press $\boxed{\text{EXE}}$ or tap with the stylus to move the cursor between lines.
- A message will appear to let you know whether or not the calculation result is valid.

Example 1: To factor 50 completely

• ClassPad Operation

- (1) Tap the right most toolbar down arrow button.
- (2) On the icon palette that appears, tap $\boxed{\text{f(x)=}}$.

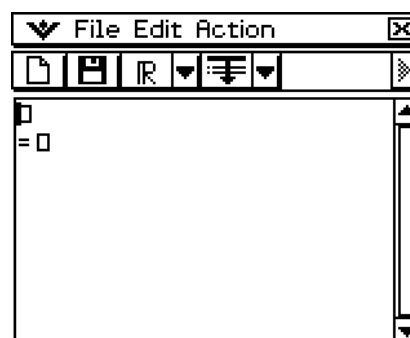

- (3) Input 50 and tap $\boxed{\text{EXE}}$.

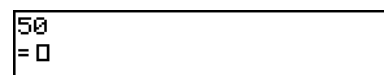

(4) Following the equal sign (=), input 25×3 and tap $\boxed{\text{EXE}}$.



(5) Tap [OK] to close the error dialog that appears.

(6) Change 25×3 to 25×2 and tap $\boxed{\text{EXE}}$.



(7) Following the next equal sign (=), input $5 \times 5 \times 2$ and tap $\boxed{\text{EXE}}$.

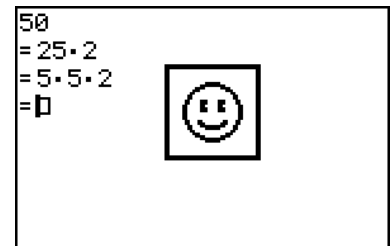
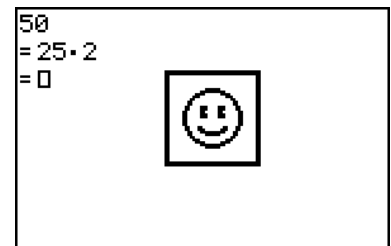

Example 2: To rewrite $x^2 + 1$ in factored form

(1) Tap the left most toolbar icon $\boxed{\text{I}}$ to begin a new Verify session.

(2) Tap [OK] to clear the window.

(3) Tap the down arrow on the toolbar and select $\boxed{\text{C}}$.

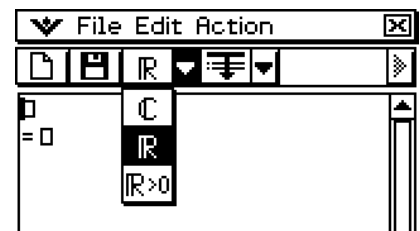

(4) Input $x^2 + 1$ and press $\boxed{\text{EXE}}$.

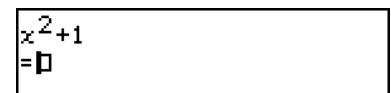

(5) Input $(x + i)(x - i)$ and press $\boxed{\text{EXE}}$.

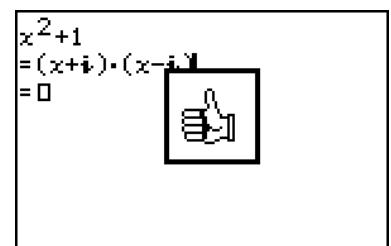

2-12 Using Probability

You can use Probability to simulate the following.

- The die faces that will appear when a single die is thrown a specified number of times (1 Die)
- The sum of the data of dice faces that will appear when a pair of dice is shown a specified number of times (2 Dice +)
- The product of the data of dice faces that will appear when a pair of dice is shown a specified number of times (2 Dice *)
- When any number of balls labeled A, B, C, D, E, and F are placed into a box, data about how many times each ball will be drawn within a specified number of draws (Container)

You can specify any integer from 1 to 20 as the number of die faces.

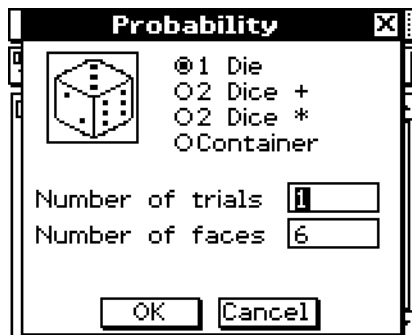

Probability dialog box
when 1 Die is selected

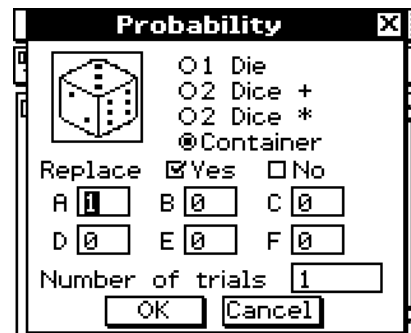

Probability dialog box
when Container is selected

You can access Probability in the Main application or the eActivity application. From either application, you can save Probability sessions in ClassPad memory and reopen the session for future use.

Probability sessions also can be inserted into an eActivity. For more information, see “10-2 Creating an eActivity”.

Important!

Most Probability operations are the same in both the Main application and the eActivity application.

Starting Up Probability

Use the following procedure to start up Probability.

• ClassPad Operation

(1) Tap the right most toolbar down arrow button.

(2) On the icon palette that appears, tap .

- This will display an initial Probability dialog box like the one shown below. You can use this dialog box to try the probability emulation.

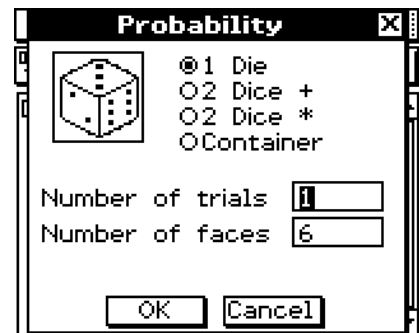

(3) Tap [OK].

- This will execute the probability emulation using the default setup (1 Die, Number of trials: 1, Number of faces: 6).

Trial information

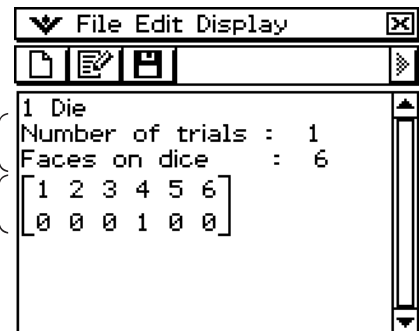

Trial result



Probability Menus and Buttons

This section provides basic information about Probability menus, commands, and buttons.

Tip

-  menu items are the same for all applications. For more information, see “Using the  Menu” on page 1-5-4.

■ File Menu

To do this:	Select this File menu item:
Discard the current window contents and create a new file	New
Open an existing file	Open
Save the current window contents to a file	Save



■ Edit Menu

To do this:	Select this Edit menu item:
Copy the currently selected object (trial information or trial result) and place it onto the clipboard	Copy
Display the Probability dialog box and try the probability emulation (the trial result will be added to the end of the current file)	Add
Delete the currently selected trial data	Delete
Clear the Probability window (and display the Probability dialog box)	Clear All

■ Display Menu

To do this:	Select this Display menu item:
Show the selected result distribution table format	Distribution
Show the selected result as a list data format	Sample Data

Tip

- Under initial default settings, trial results are shown in distribution table format. Selecting distribution table results and selecting [Sample Data] on the [Display] menu will change them to list data format. Conversely, selecting table results and selecting [Distribution] on the [Display] menu will change them to distribution table format.

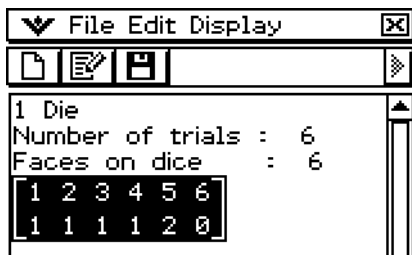

Distribution Table Format

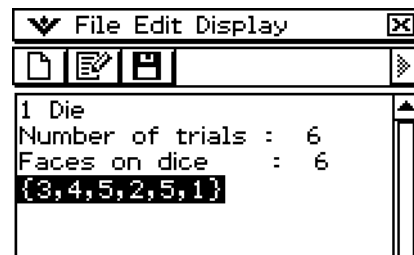

List Data Format

■ Probability Buttons

To do this:	Select this Probability button:
Discard the current window contents and create a new file	
Display the Probability dialog box and try the probability emulation	
Open an existing file	

Using Probability

The following examples show the basic steps for using Probability.

Example 1: To obtain the sum data when a two six-sided die are thrown 50 times

• ClassPad Operation

- (1) Tap the right most toolbar down arrow button.
- (2) On the icon palette that appears, tap .
 - This displays the Probability dialog box.

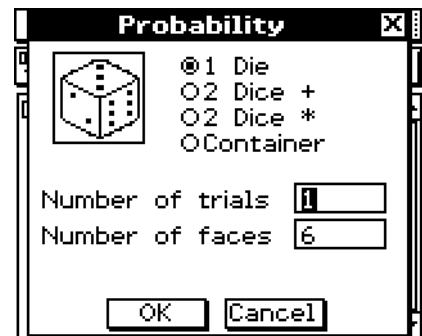

- (3) Tap the button next to "2 Dice +" to select it.
- (4) Enter 50 into the "Number of trials" box.
 - Leave the value in the "Number of faces" box at its initial default value (6).

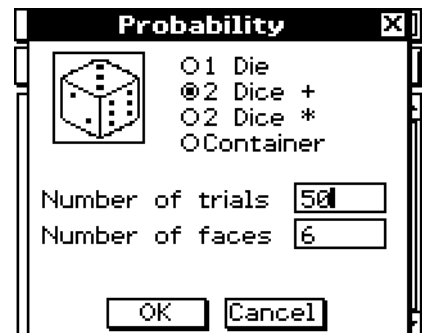

- (5) Tap [OK].
 - The result will appear in the Probability window.

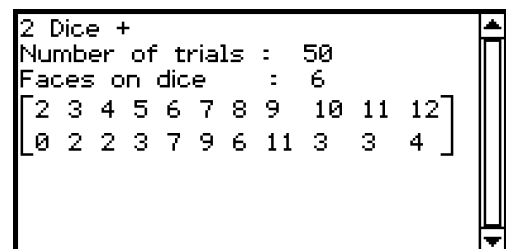

Example 2: To obtain the product data when a two six-sided die are thrown 150 times

(This example assumes you are continuing from Example 1.)

- (1) Tap  to display the Probability dialog box.
- (2) Tap the button next to “2 Dice *” to select it.
- (3) Enter 150 into the “Number of trials” box.
 - Leave the value in the “Number of faces” box at its initial default value (6).

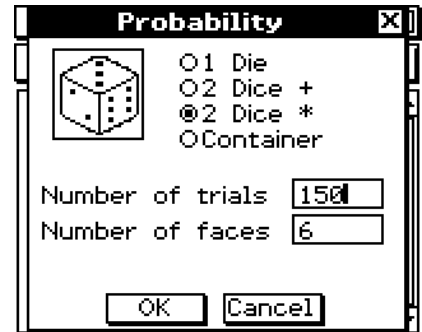

- (4) Tap [OK].
 - The result will appear in the Probability window.

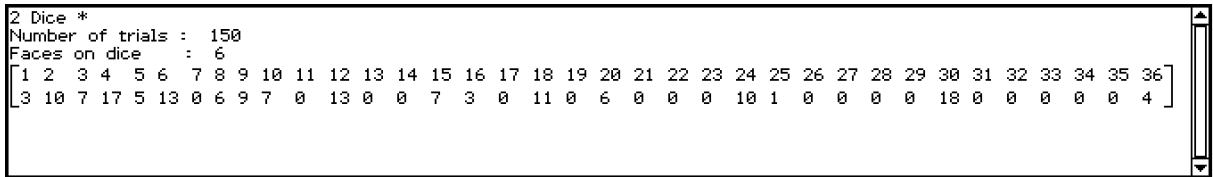

Example 3: After putting 10 A-balls, 2- B-balls, and 30 C-balls into a box, determine how many times each type of ball will be drawn when there is a total of 50 draws. Each time a ball is drawn, it should be replaced into the box before the next draw.

(This example assumes you are continuing from Example 2.)

- (1) Tap  to display the Probability dialog box.
- (2) Tap the button next to “Container” to select it.

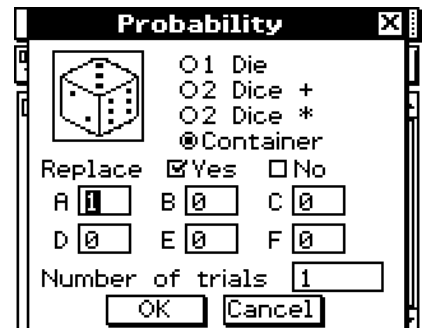

(3) Configure the following settings on the dialog box.

- Replace: Yes (Indicates the ball is replaced before the next draw. If the ball is not replaced, select “No”.)
- A: 10, B: 20, C: 30 (Leave other letters set to zero.)
- Number of trials: 50

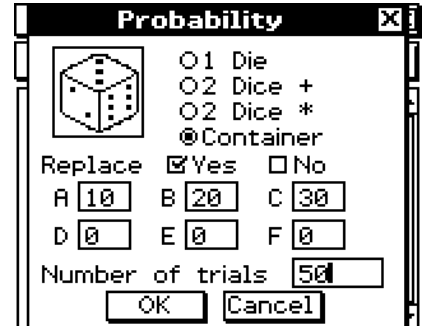

(4) Tap [OK].

- The result will appear in the Probability window.

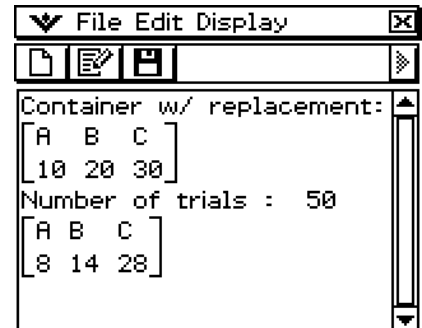

2-13 Running a Program in the Main Application

You can run a program in the Main application or the eActivity application.

Syntax: Folder name\Program name(parameter)

- You do not need to specify the folder name if the program you want to run is in the current folder. If you leave ClassPad configured with its initial default settings, the current folder for both the Program application and the Main application is the “main” folder, so you normally do not need to specify a folder name.
- Unless you change it, the current folder of the eActivity application is the “eAct” folder, so you always need to specify the folder name. If you want to run a program that is in the “main” folder, input “main\Program name(parameter)”.

Important!

If the program command “Pause” is used in a program, it is ignored when the program is called from Main or eActivity.

Program	Main application	eActivity application

Example: To run the program named OCTA that we created and stored under “Creating and Saving a Program” (page 12-2-1) from the Main application, and determine the surface area and of a regular octahedron with a side length of 20 cm

• ClassPad Operation

(1) Perform the key operation below in the Main application work area.

`abc` `CAP` `O` `C` `T` `A` `mth` `(` `)`

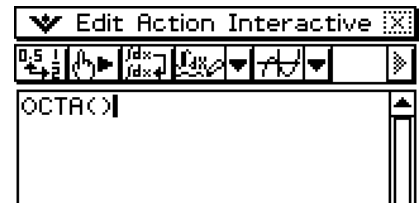

(2) Tap `EXE`.

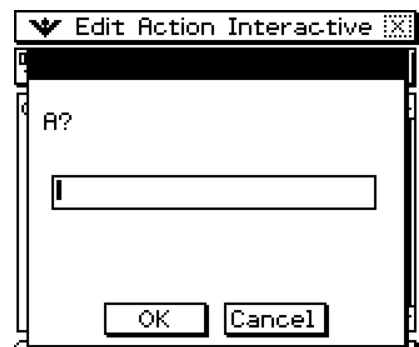

(3) Enter 20 and then tap `[OK]`.

- This will run OCTA and display the results in the program output window.

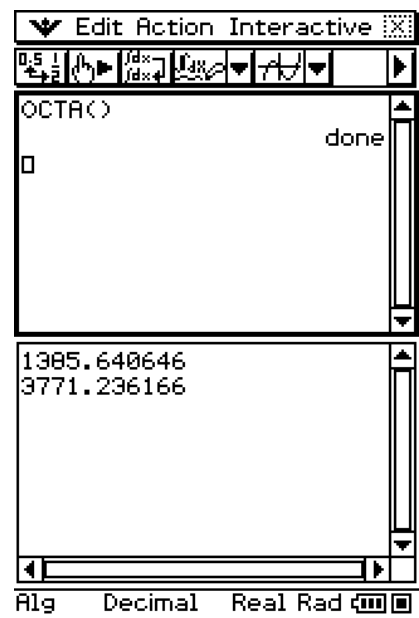

Program output window

(4) To close the program output window, tap anywhere inside it and then tap the `✕` button in upper right corner.

Using the Graph & Table Application

The Graph & Table application allows you to input and graph rectangular coordinate equations (or inequalities), polar coordinate equations, and parametric expressions. After you graph an expression, you can zoom in or out, and move a pointer along the graph, displaying its coordinates as you go. You can also perform various graph-based analytical operations to determine the points of intersect of two graphs, and to determine the maximum, minimum, point of inflection, and definite integral for a particular range of a parabola or other figure. You can even generate number tables and summary tables for functions that you input.

- 3-1 Graph & Table Application Overview**
- 3-2 Using the Graph Window**
- 3-3 Storing Functions**
- 3-4 Using Table & Graph**
- 3-5 Modifying a Graph**
- 3-6 Using the Sketch Menu**
- 3-7 Using Trace**
- 3-8 Analyzing a Function Used to Draw a Graph**

3-1 Graph & Table Application Overview

This section describes the configuration of the Graph & Table application windows and provides basic information about its menus and commands.

Starting Up the Graph & Table Application

Use the following procedure to start up the Graph & Table application.

• ClassPad Operation

On the application menu, tap .

This starts the Graph & Table application and displays the Graph Editor window and the Graph window.

Graph & Table Application Window

When you start up the Graph & Table application, two windows appear on the display: the Graph Editor window and the Graph window.

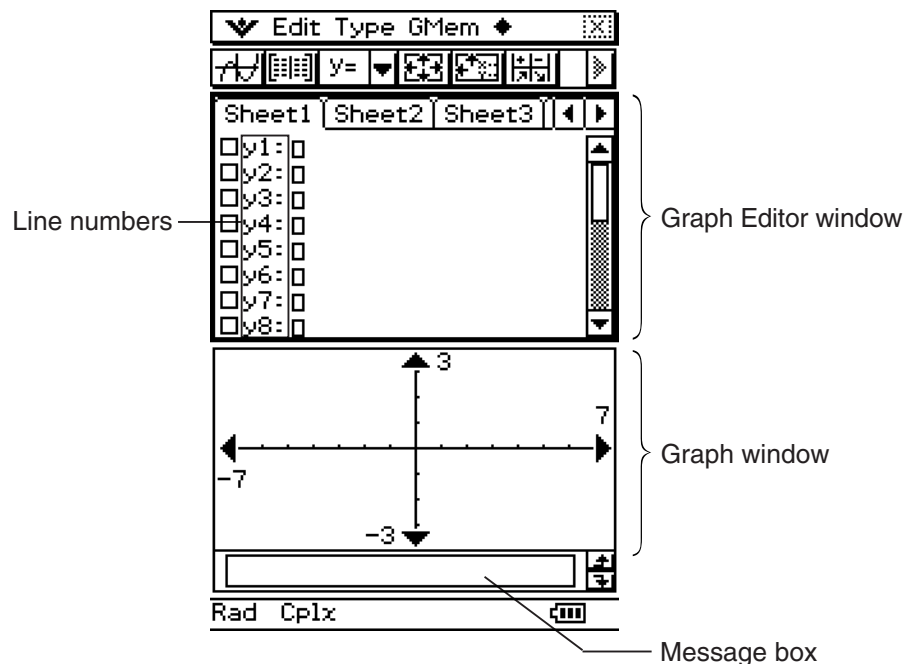

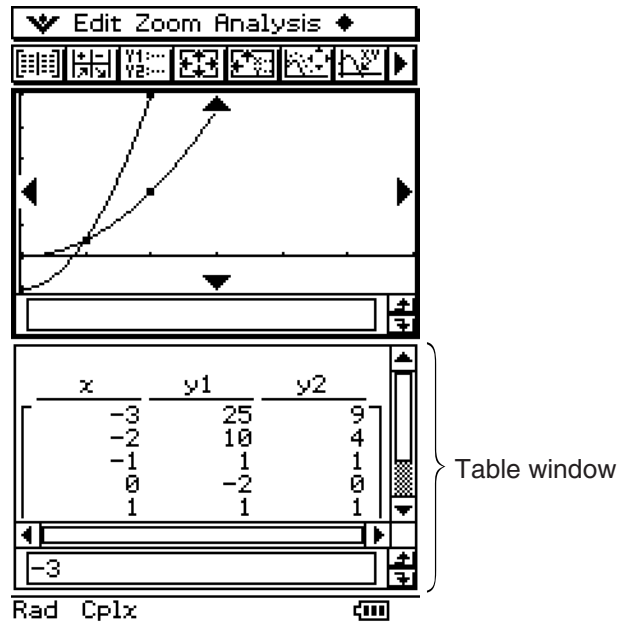

- A Graph Editor sheet can contain up to 20 functions. You can have up to 100 functions stored in the Graph Editor at one time. Functions stored in the Graph Editor can be graphed on the Graph window.
- The Graph window and Table window have a message box along the bottom that can display expressions and values, or be used for input and editing.

You can also use a function on the Graph Editor window to generate a number table or a summary table. Number tables and summary tables are displayed in a Table window.





























Graph & Table Application Menus and Buttons

This section explains the operations you can perform using the Graph & Table application menus and buttons.



- For information about the  menu, see “Using the  Menu” on page 1-5-4.

■ Graph Editor Window Menus and Buttons









To do this:	Tap this button:	Or select this menu item:
Cut the selected character string and place it onto the clipboard	—	Edit - Cut
Copy the selected character string to the clipboard	—	Edit - Copy
Paste the contents of the clipboard at the current cursor position in the Graph Editor window	—	Edit - Paste
Select the entire expression you are editing	—	Edit - Select All
Clear all of the expressions from the Graph Editor window	—	Edit - Clear All
Input a rectangular coordinate type function		Type - y= Type
Input a polar coordinate type function		Type - r= Type
Input a parametric function		Type - ParamType
Input an X equality		Type - x= Type







To do this:	Tap this button:	Or select this menu item:
Input a rectangular coordinate type inequality		Type - $y >$ Type
		Type - $y <$ Type
		Type - $y \geq$ Type
		Type - $y \leq$ Type
Input an X inequality		Type - $x >$ Type
		Type - $x <$ Type
		Type - $x \geq$ Type
		Type - $x \leq$ Type
Input two functions in a list and shade between them		Type - ShadeType
Save all of the expressions on the Graph Editor window	—	GMem - Store
Recall batch saved data to the Graph Editor window	—	GMem - Recall
Display the Dynamic Graph dialog box (page 3-5-4)	—	 - Dynamic Graph
Display the Draw Shade dialog box (page 3-3-12)	—	 - Draw Shade
Use a built-in function for input	—	 - Built-In
Specify “AND Plot” as the inequality plot setting	—	 - Inequality Plot - and
Specify “OR Plot” as the inequality plot setting	—	 - Inequality Plot - or
Delete all of the expressions on the active sheet	—	 - Sheet - Clear Sheet
Return all sheet names to their initial defaults	—	 - Sheet - Default Name
Graph the selected function(s)		—
Generate a summary table for the selected function		—
Display the View Window dialog box to configure Graph window settings		 - View Window
Display the Table Input dialog box for configuring settings		—
Generate a table for the selected function		—
Display the Variable Manager (page 1-8-1)	—	 - Variable Manager

■ Graph Window Menus and Buttons



To do this:	Tap this button:	Or select this menu item:
Cut the character string selected in the message box and place it onto the clipboard	—	Edit - Cut
Copy the character string selected in the message box to the clipboard	—	Edit - Copy
Paste the contents of the clipboard at the current cursor position in the message box	—	Edit - Paste
Select all of the text in the message box	—	Edit - Select All
Clear all of the Graph window contents	—	Edit - Clear All
Enlarge the part of the screen bounded by a box		Zoom - Box
Specify a zoom factor	—	Zoom - Factor
Zoom in by the zoom factor	—	Zoom - Zoom In
Zoom out by the zoom factor	—	Zoom - Zoom Out
Configure View Window y -axis parameters and redraw the graph so it fills the graph screen along the y -axis		Zoom - Auto
Return a graph to its original size	—	Zoom - Original
Adjust View Window x -axis values so they are identical to the y -axis values	—	Zoom - Square
Round coordinate values displayed using Trace (page 3-7-1)	—	Zoom - Round
Make the value of each dot equal 1, which makes all coordinate values integers	—	Zoom - Integer
Return View Window parameters to their settings prior to the last zoom operation	—	Zoom - Previous
Perform a quick zoom operation (page 3-2-9)	—	Zoom - Quick Initialize
	—	Zoom - Quick Trig
	—	Zoom - Quick $\log(x)$
	—	Zoom - Quick e^x
	—	Zoom - Quick x^2
	—	Zoom - Quick $-x^2$
	—	Zoom - Quick Standard







To do this:	Tap this button:	Or select this menu item:
Display the coordinates at a particular point on a graph		Analysis - Trace
Insert a point, graphic, or text into an existing graph (page 3-6-1)	—	Analysis - Sketch
Obtain the root (x -intercept) of a graph		Analysis - G-Solve - Root
Obtain the maximum value of a graph		Analysis - G-Solve - Max
Obtain the minimum value of a graph		Analysis - G-Solve - Min
Obtain the maximum value in the range displayed on the Graph window	—	Analysis - G-Solve - fMax
Obtain the minimum value in the range displayed on the Graph window	—	Analysis - G-Solve - fMin
Obtain the y -intercept of a graph	—	Analysis - G-Solve - y -Intercept
Obtain the point of intersection for two graphs	—	Analysis - G-Solve - Intersect
Obtain the y -coordinate for a given x -coordinate	—	Analysis - G-Solve - y -Cal
Obtain the x -coordinate for a given y -coordinate	—	Analysis - G-Solve - x -Cal
Obtain the definite integral for a particular range	—	Analysis - G-Solve - $\int dx$
Obtain the point of inflection	—	Analysis - G-Solve - Inflection
Obtain the distance between two points	—	Analysis - G-Solve - Distance
Obtain the volume of a solid of revolution	—	Analysis - G-Solve - $\pi \int (f(x))^2 dx$
Modify a graph by changing the value of a coefficient	—	Analysis - Modify
Save a graph as image data (page 3-2-10)	—	 - Store Picture
Recall the image of a graph (page 3-2-10)	—	 - Recall Picture
Display the Dynamic Graph dialog box (page 3-5-4)	—	 - Dynamic Graph
Display the Draw Shade dialog box (page 3-3-12)	—	 - Draw Shade
Use a built-in function template to input a function for graphing • Note that built-in functions are graphed automatically and cannot be used for input on the Graph Editor window.	—	 - Built-In

To do this:	Tap this button:	Or select this menu item:
Specify “AND Plot” as the inequality plot setting	—	◆ - Inequality Plot - and
Specify “OR Plot” as the inequality plot setting	—	◆ - Inequality Plot - or
Re-draw a graph	—	◆ - ReDraw
Make the Graph Editor window active		—
Generate a number table for an existing graph		—
Display the View Window dialog box to configure Graph window settings		▼ - View Window
Display the Table Input dialog box for configuring settings		—
Pan the Graph window		—
Display the Variable Manager (page 1-8-1)	—	▼ - Variable Manager
Generate a summary table for an existing graph		—

■ Table Window Menus and Buttons

To do this:	Tap this button:	Or select this menu item:
Cut the character string selected in the message box and place it onto the clipboard	—	Edit - Cut
Copy the character string selected in the message box to the clipboard	—	Edit - Copy
Paste the contents of the clipboard at the current cursor position in the message box	—	Edit - Paste
Select all of the text in the message box	—	Edit - Select All
Clear all of the Table window contents	—	Edit - Clear All
Delete a line from a table	—	T-Fact - Delete
Insert a line into a table	—	T-Fact - Insert
Add a line after the currently selected line	—	T-Fact - Add
Draw a connect type graph using a generated table		Graph - G-Connect
Draw a plot type graph using a generated table		Graph - G-Plot
Save the contents of a table to a list	—	◆ - Table to List
Re-generate a table based on current table settings	—	◆ - ReTable
Delete the displayed table	—	◆ - Delete Table
Move the pointer to the location on a graph that corresponds to the value selected in a table	—	◆ - Link

To do this:	Tap this button:	Or select this menu item:
Make the Graph Editor window active		—
Display the View Window dialog box to configure Graph window settings		 - View Window
Display the Table Input dialog box for configuring settings		—
Display the Variable Manager (page 1-8-1)	—	 - Variable Manager

Graph & Table Application Status Bar

The status bar at the bottom of the Graph & Table application shows the current angle unit setting and [Complex Format] setting (page 1-9-5).

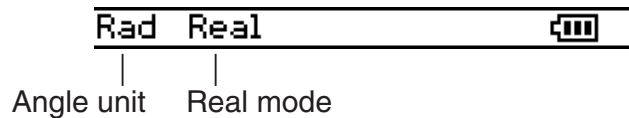

If you see this:	It means this:
Rad	The angle unit setting is radians.
Deg	The angle unit setting is degrees.
Gra	The angle unit setting is grads.
Cplx	The Complex (complex number calculation) mode is selected.
Real	The Real (real number calculation) mode is selected.

Graph & Table Application Basic Operations

This section explains how to input a function on the Graph Editor window and then graph it on the Graph window. These are the most basic operations you can perform with the Graph & Table application.

■ Function Storage and Graphing Example

This example shows how to input two functions on Sheet 1 of the Graph & Table application, and then draw their graphs.

Tip

- The Graph Editor window has five sheets, named Sheet 1 through Sheet 5, for input of expressions. For more information, see “Using Graph Editor Sheets” on page 3-3-1.

Example 1: To input the function $y = 3x^2$ on Sheet 1 and graph it

• ClassPad Operation

(1) On the application menu, tap .

- This starts the Graph & Table application.

(2) In the Graph Editor window, tap the input box immediately to the right of line number y1.

- This locates the cursor in the input box for line y1.

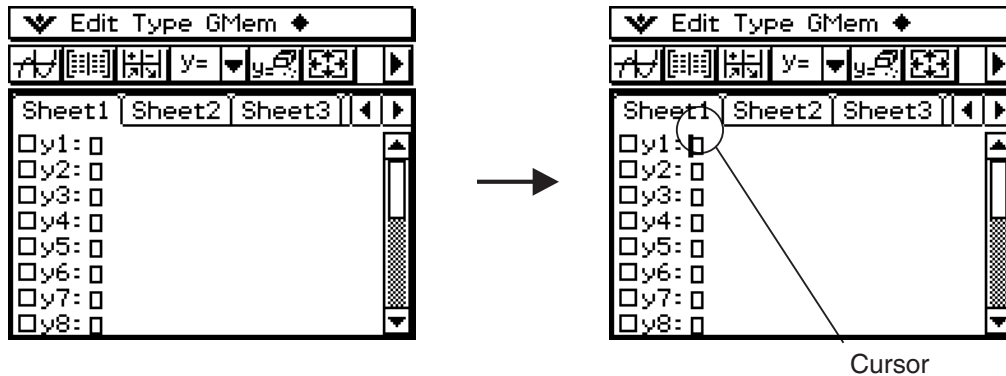

(3) Input the expression.

- Pressing  stores the expression you input and puts a check mark into the check box to the left of line number y1. When a line number has a check mark next to it, it means that the expression is currently selected for graphing.

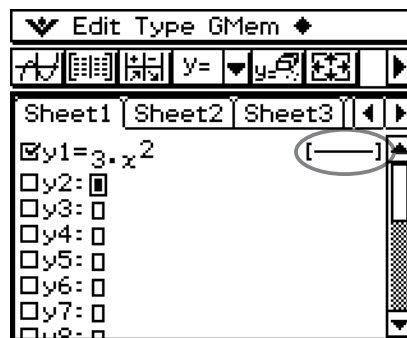

When you input an expression, the line style that will be used for the graph will appear here. See page 3-3-8 for information about configuring line settings.

Hint:

Tap the line that is circled above!

(4) Tap .

- This graphs the expression.

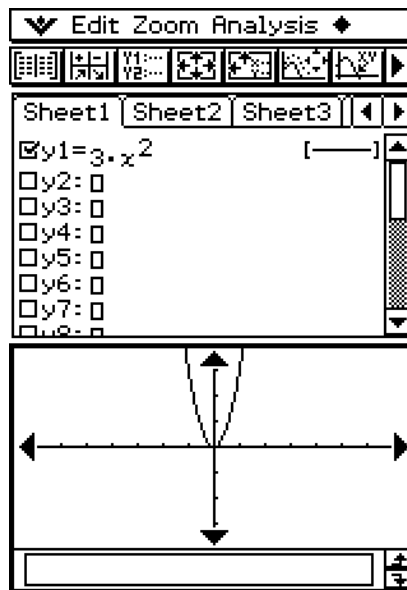

The expression is displayed in the message box while the graph is being drawn.

Tip

- The Graph window message box is for both input and output. It displays information about the function and other information. You can also use it to edit the function, which causes the graph to change shape. Details about the information that appears in the message box and how to use the message box are covered on page 1-6-8.

Example 2: To input the function $r = 3\sin 2\theta$ into line 2 of Sheet 1 and graph it

In Example 1, we graphed a rectangular expression in the form of $y = f(x)$. You can also input polar coordinate expressions, inequalities, and other types of functions for graphing as well. In this example, we input and graph the polar coordinate expression $r = 3\sin 2\theta$. Note that the following sample procedure assumes that you have already completed the steps for Example 1.

• ClassPad Operation

- (1) Tap anywhere inside of the Graph Editor window to make it active.
- (2) Tap the down arrow next to “y=”, or on the menu tap [Type]. On the list that appears, tap “r=”.

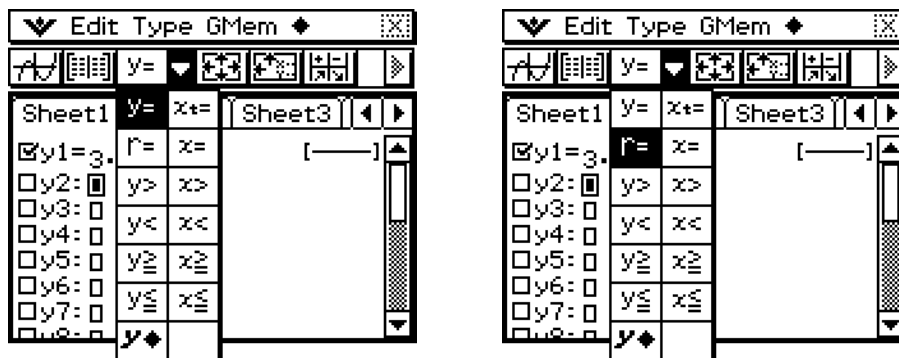

- This causes the line numbers next to any line on the Graph Editor window that does not contain an expression to change from “y” to “r” (r_2 , r_3 , etc.). The line numbers of lines that already contain expressions do not change.

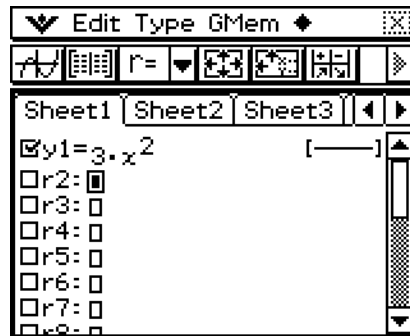

- (3) Tap the input box to the right of line number r_2 and input the expression.

Keyboard **mth** **3** **TRIG** **sin** **2** **θ** **)** **EXE**

- Tapping **EXE** stores the expression you input and puts a check mark into the check box to the left of line number r_2 . When a line number has a check mark next to it, it means that the expression is currently selected for graphing.

(4) Tap .

- Since there are check marks next to both “y1” and “r2”, both expressions are graphed.

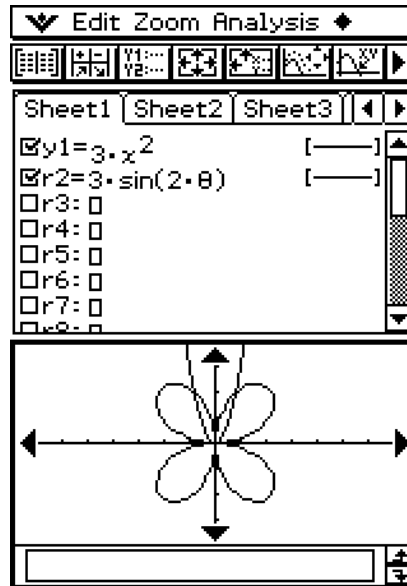



3-2 Using the Graph Window

This section explains Graph window operations, including configuring display settings, scrolling, zooming the image, and more.

Configuring View Window Parameters for the Graph Window

The View Window dialog box lets you specify the maximum and minimum values for each axis, the space between the marks on each axis (the scale), and other graph display parameters. Before drawing a graph, be sure to first configure View Window parameters to ensure proper display of the graph.

- **To configure View Window parameters**

- (1) On the application menu, tap  .
- (2) Tap , or tap  and then [View Window].
 - This displays the View Window dialog box.

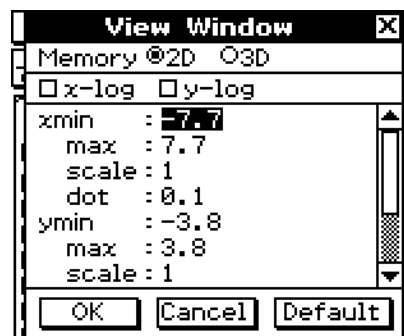

- (3) Tap the “2D” option button so the option is selected.
- (4) Configure View Window parameters required for the type of graph you want to draw.
 - Press  to move the cursor and then input an appropriate value for each parameter.

Rectangular Coordinates

Use this item:	To configure this View Window parameter:
xmin	x -axis minimum value
xmax	x -axis maximum value
xscale	x -axis marker spacing
xdot	Value of each dot on the x -axis
ymin	y -axis minimum value
ymax	y -axis maximum value
yscale	y -axis marker spacing
ydot	Value of each dot on the y -axis

- You can also use the rectangular coordinate View Window dialog box to select x -log graph, y -log graph, or xy -log graph.

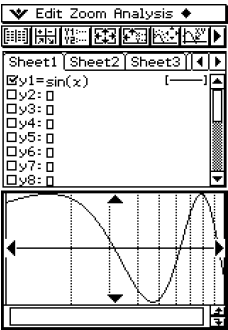
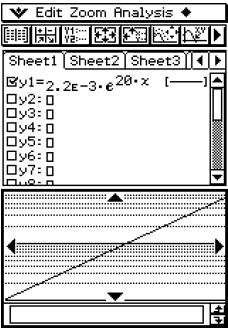
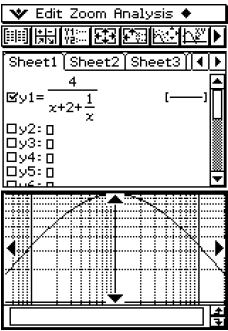
To select this type of graph:	Do this:
<p>x-log graph</p> 	<p>Select the x-log check box.</p> <ul style="list-style-type: none"> This automatically sets “xdot” and “xscale” to “Auto”.
<p>y-log graph</p> 	<p>Select the y-log check box.</p> <ul style="list-style-type: none"> This automatically sets “ydot” and “yscale” to “Auto”.
<p>xy-log graph</p> 	<p>Select the x-log check box and the y-log check box.</p> <p>This automatically sets “xdot”, “xscale”, “ydot”, and “yscale” to “Auto”.</p>

Polar Coordinates and Parametric Coordinates

Use this item:	To configure this View Window parameter:
$t\theta$ min	Minimum value of $t\theta$
$t\theta$ max	Maximum value of $t\theta$
$t\theta$ step	Step size of $t\theta$

(5) After all the parameters are the way you want, tap [OK].

Tip

- When you tap [OK] after changing View Window dialog box settings while the Graph window is active, the graph is redrawn automatically using the new View Window settings.
- If the Graph window is not active, tapping [OK] closes the View Window dialog box without redrawing the graph. To redraw the graph in this case, tap  on the Graph Editor window.

• View Window parameter precautions

- An error occurs if you input 0 for $t\theta$ step.
- An error also occurs if you input a value that is out of range for a parameter, if you input a minus sign only, or if you perform any other illegal input.
- An error occurs if y_{\min} is greater than or equal to the y_{\max} . The same is also true for the x_{\min} and x_{\max} . If the value you specify for $t\theta_{\min}$ is greater than the value you specify for $t\theta_{\max}$, the $t\theta$ step setting is automatically changed to a negative value.
- When the View Window setting produces an axis that does not fit on the display, the scale of the axis is indicated on the edge of the display closest to the origin.
- Changing the x_{\min} (y_{\min}) or x_{\max} (y_{\max}) value automatically changes the x_{dot} (y_{dot}) value, while changing the x_{dot} (y_{dot}) value automatically changes the x_{\max} (y_{\max}) value.

• To initialize View Window parameters

(1) On the application menu, tap  .

(2) Tap  . This displays the View Window dialog box.

(3) Tap [Memory] and then [Initial]. This initializes View Window parameters to the values noted below.

$x_{\min} = -7.7$ $x_{\max} = 7.7$ $x_{\text{scale}} = 1$ $x_{\text{dot}} = 0.1$
 $y_{\min} = -3.8$ $y_{\max} = 3.8$ $y_{\text{scale}} = 1$ $y_{\text{dot}} = 0.1$
 $t\theta_{\min} = 0$ $t\theta_{\max} = 6.28318530717$ $t\theta_{\text{step}} = 0.05235987755$

• To initialize the View Window for an angle unit

(1) On the application menu, tap  .

(2) Tap  . This displays the View Window dialog box.

(3) Tap [Memory] and then [Trigonometric]. This initializes View Window parameters in accordance with the angle unit, as shown below.



(Setup: Radian)

$x_{\min} = -9.4247779607$ $x_{\max} = 9.42477796076$
 $x_{\text{scale}} = 1.57079632679$ $x_{\text{dot}} = 0.12239971377$
 $y_{\min} = -1.6$ $y_{\max} = 1.6$
 $y_{\text{scale}} = 0.5$ $y_{\text{dot}} = 0.04210526315$
 $t\theta_{\min} = 0$ $t\theta_{\max} = 6.28318530717$
 $t\theta_{\text{step}} = 0.05235987755$

(Setup: Degree)



$x_{\min} = -540$ $x_{\max} = 540$ $x_{\text{scale}} = 90$ $x_{\text{dot}} = 7.01298701298$
 $y_{\min} = -1.6$ $y_{\max} = 1.6$ $y_{\text{scale}} = 0.5$ $y_{\text{dot}} = 0.04210526315$
 $t\theta_{\min} = 0$ $t\theta_{\max} = 360$ $t\theta_{\text{step}} = 3$

• To standardize the View Window

- (1) On the application menu, tap  .
- (2) Tap  . This displays the View Window dialog box.
- (3) Tap [Memory] and then [Standard]. This applies the standard View Window parameters shown below.

$x_{\min} = -10$ $x_{\max} = 10$ $x_{\text{scale}} = 1$ $x_{\text{dot}} = 0.12987012987$
 $y_{\min} = -10$ $y_{\max} = 10$ $y_{\text{scale}} = 1$ $y_{\text{dot}} = 0.26315789473$
 $t\theta_{\min} = 0$ $t\theta_{\max} = 6.28318530717$ $t\theta_{\text{step}} = 0.05235987755$

• To auto configure View Window parameters

- (1) On the application menu, tap  .
- (2) Tap  . This displays the View Window dialog box.
- (3) Tap [Memory] and then [Auto]. This causes View Window parameters to be configured automatically in accordance with the function on the Graph Editor window.
 - When multiple expressions are selected for graphing, the one with the lowest numbered line is used for auto setting of View Window parameters.



Tip

- Initializing or standardizing View Window parameters causes polar/parametric coordinate values $t\theta_{\min}$, $t\theta_{\max}$, and $t\theta_{\text{step}}$ to be adjusted automatically in accordance with the currently selected angle unit. In the Degree mode, for example, the following settings are configured:
 $t\theta_{\min} = 0$, $t\theta_{\max} = 360$, $t\theta_{\text{step}} = 3$



■ Using View Window Memory

You can store your custom View Window settings for later use.

• To save the current View Window setup

- (1) On the application menu, tap  .
- (2) Tap  .
- (3) On the View Window dialog box, configure the parameters you want.
- (4) Tap [Memory] and then [Store]. This displays a dialog box for inputting a name for the View Window setup.
- (5) Enter the name and then tap [OK].

• **To recall a setup from View Window memory**

- (1) On the application menu, tap  .
- (2) Tap  . This displays the View Window dialog box.
- (3) Tap [Memory] and then [Recall]. This displays a list of names of the View Window setups you have stored in memory.
- (4) Select the name of the setup you want, and then tap [OK].

Tip

- Recalling a View Window setup causes the current View Window parameters to be replaced by the parameters of the recalled setup.

Viewing Graph Window Coordinates

Tapping and holding a point on Graph window with the stylus will display the coordinates at that location in the status bar.

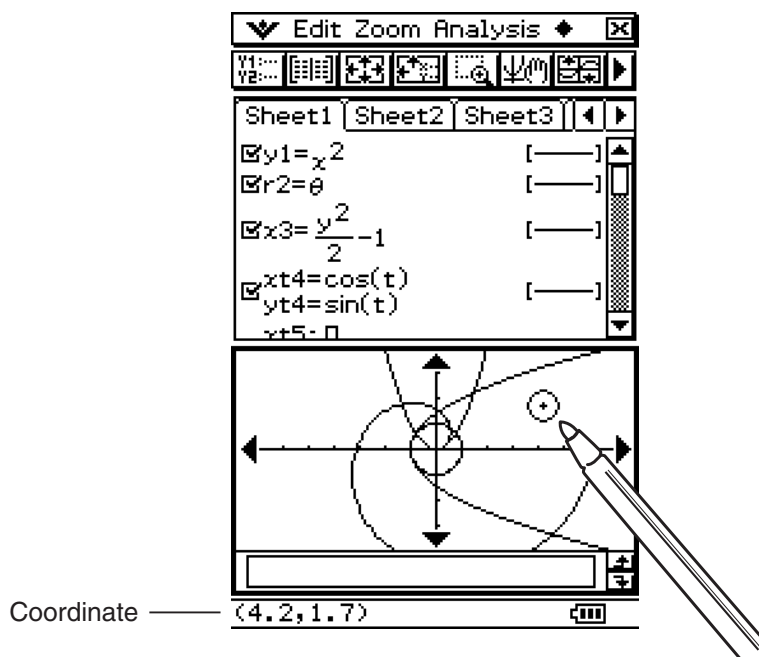

Scrolling the Graph Window

After drawing a graph, you can use either of the two operations to scroll it up, down, left, or right.

- Tap the graph controller arrows at the edges of the Graph window.
- Use the cursor key.

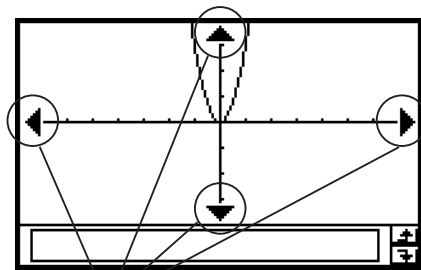

Graph controller arrows

Tip

- Display of the graph controller arrows is turned off under initial default settings. Use the Graph Format dialog box to turn them on, if you want. For more information, see “Application Format Settings” on page 1-9-4.
- You can also use the graph controller arrows and cursor key to change the configuration of a graph. For details, see “3-5 Modifying a Graph”.

Panning the Graph Window

Placing the stylus against the Graph window and dragging causes the window to scroll automatically in the direction you drag.

• ClassPad Operation

- (1) Tap the Graph window to make it active.
- (2) Tap .
- (3) Holding the stylus anywhere against the Graph window, drag it in the direction you want.
 - This causes the Graph window to scroll automatically in accordance with the dragging.

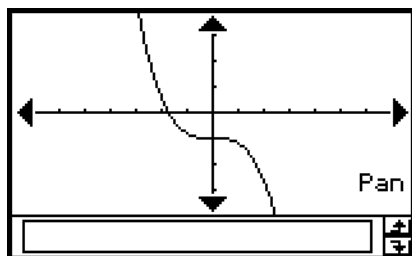

After  is tapped

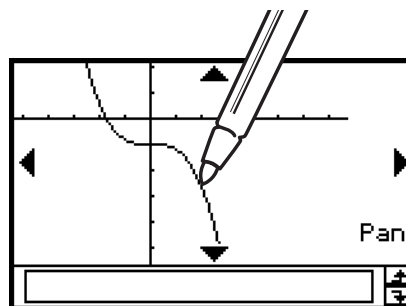

While panning

- (4) When the Graph window shows the area you want, remove the stylus from the display.
 - This causes the graph to be redrawn on the Graph window.

Zooming the Graph Window

Your ClassPad provides you with a wide selection of zoom commands that you can use to enlarge or reduce an entire graph or a specific area of a graph.



■ Zoom Commands

The Graph window's [Zoom] menu contains the zoom commands described in the table below.

Zoom Command	Description
Box	With "box zoom", you draw a selection boundary around the area you would like to enlarge. This causes the selected area to be enlarged so it fills the entire graph display.
Factor Zoom In Zoom Out	"Factor zoom" lets you specify a zoom factor for enlarging or reducing a graph. Use the [Factor] command to configure zoom factor settings, the [Zoom In] command to zoom in, and the [Zoom Out] command to zoom out.
Auto	"Auto zoom" automatically configures View Window y -axis values and redraws the graph so it fills the Graph window along the y -axis.
Original	Return a graph to its original View Window settings
Square	Executing this command adjusts View Window x -axis values so that they are identical to the y -axis values.
Round	Round View Window settings (xmin, xmax, xdot) to an appropriate number of decimal places and redraw the graph.
Integer	This command makes the value of each dot equal 1, which makes all coordinate values integers.
Previous	Performing a zoom operation changes View Window parameter values. Execute this command to return View Window parameters to their settings prior to the last zoom operation.
Quick Initialize Quick Trig Quick log (x) Quick e^x Quick x^2 Quick $-x^2$ Quick Standard	These seven quick zoom commands cause the graph to be redrawn using preset View Window parameter values (page 3-2-9).

• To use box zoom

Example: To use box zoom to enlarge part of the graph $y = (x + 5)(x + 4)(x + 3)$

- (1) On the application menu, tap  .
- (2) On the Graph Editor window, input $y = (x + 5)(x + 4)(x + 3)$.
 - For details about how to input an expression, see “Function Storage and Graphing Example” on page 3-1-7 and “3-3 Storing Functions”.
- (3) Tap  to graph the functions.
- (4) Tap [Zoom] and then [Box], or tap .
- (5) On the Graph window, drag the stylus to draw a selection boundary around the area you want to enlarge.
- (6) Remove the stylus from the display and the area within the selection boundary expands to fill the entire Graph window.

Box Zoom Result

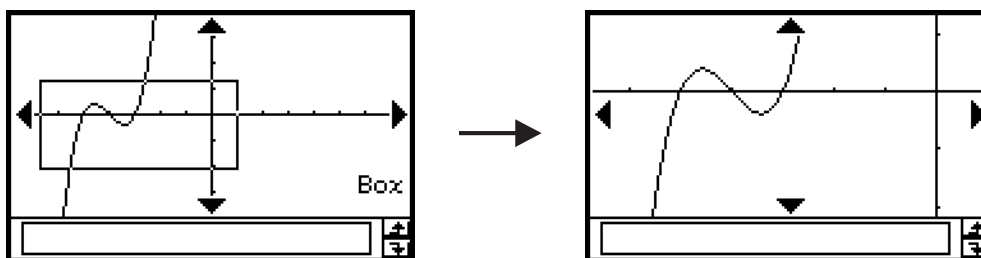



• To use factor zoom

Example: To enlarge the graphs of the following two expressions, by a factor of 5 in both directions, to determine whether they come into contact with each other

$$y1 = (x + 4)(x + 1)(x - 3)$$

$$y2 = 3x + 22$$

- (1) On the application menu, tap  .
- (2) On the Graph Editor window, input $y1 = (x + 4)(x + 1)(x - 3)$ and $y2 = 3x + 22$.
 - For details about how to input an expression, see “Function Storage and Graphing Example” on page 3-1-7 and “3-3 Storing Functions”.
- (3) Tap  to display the View Window, and then configure it with the following parameters.

$xmin = -8, \quad xmax = 8, \quad xscale = 1$
 $ymin = -30, \quad ymax = 30, \quad yscale = 5$

 - See “To configure View Window parameters” on page 3-2-1.
- (4) Tap  to graph the functions.
- (5) Tap [Zoom] and then [Factor].
 - This displays a dialog box for configuring x - and y -axis zoom factor settings.

- (6) Input 5 for both the x Factor and y Factor, and then tap [OK].
- (7) Tap , and then use the stylus to drag the screen image so the part you want to zoom is in the center of the screen.
- (8) Tap [Zoom] and then [Zoom In].

Factor Zoom Result

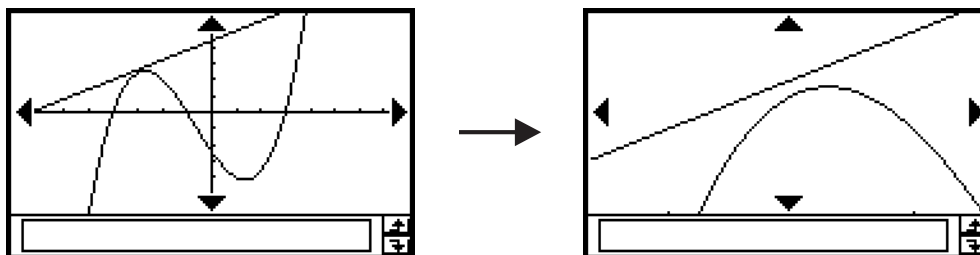

■ Using Quick Zoom

The seven quick zoom commands draw a graph using preset built-in View Window parameter values.

Command	View Window Parameter Values					
	xmin	xmax	xscale	ymin	ymax	yscale
Quick Initialize	-7.7	7.7	1	-3.8	3.8	1
Quick Trig	-9.424 (-3π)	9.424 (3π)	1.570 ($\pi/2$)	-1.6	1.6	0.5
Quick $\log(x)$	-2	13.4	2	-3.8	3.8	1
Quick e^x	-2.2	2.2	1	-1.4	9	1
Quick x^2	-7.7	7.7	2	-10	66	5
Quick $-x^2$	-7.7	7.7	2	-66	10	5
Quick Standard	-10	10	1	-10	10	1

The applicable set of View Window parameter values is applied as soon as you select a quick zoom command on the Graph window's [Zoom] menu.



Tip

- Any View Window parameter that is not shown in the above table is unchanged when you execute a quick zoom command.
- When the angle unit setting is degrees, Quick Trig configures the following values.
 $x_{\min} = -540$, $x_{\max} = 540$, $x_{\text{scale}} = 90$
 $y_{\min} = -1.6$, $y_{\max} = 1.6$, $y_{\text{scale}} = 0.5$

■ Using Other Zoom Menu Commands

The [Auto], [Original], [Square], [Round], [Integer], and [Previous] zoom commands are executed as soon as you tap one of them on the Graph window's [Zoom] menu. For information about what each command does, see "Zoom Commands" on page 3-2-7.

Tip

- For auto zoom, you can tap the  button instead of using the [Zoom] - [Auto] menu command.
- With Integer Zoom, tap  and then use the stylus to drag the screen image so the part you want to zoom is in the center of the screen.



Other Graph Window Operations

This section explains how to save a screenshot of the Graph Window, how to redraw a graph, how to make the Graph Editor Window the active window.



■ Saving a Screenshot of a Graph

Use the following procedures to save a screenshot of a graph as image data for later recall.

● To save a screenshot of a graph

- (1) On the application menu, tap  .
- (2) Draw the graph you want to save.
- (3) Tap  and then [Store Picture]. This displays a dialog box for inputting a name for the screenshot.
- (4) Enter the name and then tap [OK].

● To recall a screenshot of a graph

- (1) On the application menu, tap  .
- (2) Tap the Graph window to make it active.
- (3) Tap  and then [Recall Picture]. This displays a list of names of graph images you have stored in memory.
- (4) Select the name of the image you want, and then tap [OK].



■ Redrawing a Graph

Use the following procedure to redraw a graph when necessary.

● ClassPad Operation

(1) Tap the Graph window to make it active.



(2) Tap  and then [ReDraw].

- While the Graph Editor window is active, you can redraw the graph by tapping .

Important!

- Use the  - [ReDraw] command to redraw a graph that you drew by dragging an expression from another window to the Graph window (see “2-10 Using the Main Application in Combination with Other Applications”), or a graph you modified using some Sketch menu (see “3-6 Using the Sketch Menu”). After deleting the redrawn graph, you can redraw the graph of the expression selected on the Graph window by tapping [Analysis], [Sketch], and then [Cls].

■ Making the Graph Editor Window the Active Window

While the Graph window is active, you can make the Graph Editor window the active window by tapping anywhere inside of it, by tapping , or by tapping  and then [Graph Editor].



3-3 Storing Functions

Use the Graph Editor window to store a Graph & Table application function. This section covers Graph Editor operations, and explains how to store functions.

Using Graph Editor Sheets

The Graph Editor window has five tabbed sheets named Sheet 1 through Sheet 5, each of which can contain up to 20 functions. You can have up to 100 functions stored in the Graph Editor at one time.

You can graph up to 20 functions simultaneously, as long as all of the functions are on the same sheet.

■ Selecting a Sheet

Use the operations described below to change from one sheet to another.

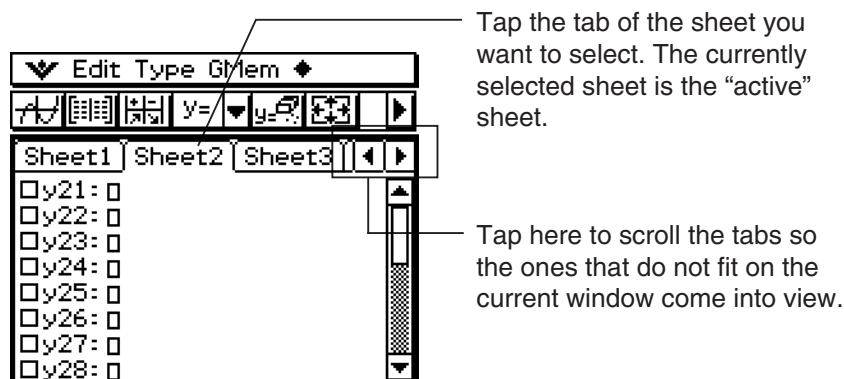

■ Renaming a Sheet

Initially, the five sheets are assigned default names from Sheet 1 through Sheet 5. You can use these sheet names as they are, or you can perform the steps below to rename a sheet.

• ClassPad Operation

- (1) Tap the tab of the sheet you want to rename so that sheet becomes active.
- (2) Tap the tab of the active sheet again.
 - This displays a dialog box for inputting a sheet name.

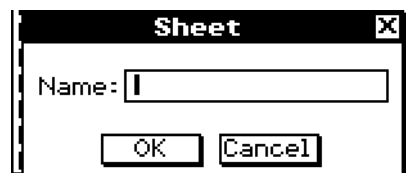

- (3) Enter up to 8 bytes for the sheet name, and then tap [OK].

■ Returning Sheets to Their Default Names

The procedure below returns the sheet names to their initial default names (Sheet 1 through Sheet 5).

● ClassPad Operation

- (1) Tap the Graph Editor window to make it active.
- (2) Tap , [Sheet], and then [Default Name].
 - This returns the currently active sheet to its default name.

■ Initializing a Sheet

The following procedure initializes a sheet, which clears all of its functions and renames the sheet to its default name.

● ClassPad Operation

- (1) If the sheet you want to initialize is not active, tap its tab.
 - (2) Tap , [Sheet], and then [Clear Sheet].
 - (3) In response to the confirmation message that appears, tap [OK] to initialize the sheet or [Cancel] to cancel the operation.
- For details about editing and deleting individual functions, see “Editing Stored Functions” on page 3-3-6.
 - You can delete all expressions on all of the sheets by tapping [Edit] and then [Clear All]. For more information, see “Deleting All Graph Editor Expressions” on page 3-3-7.

Specifying the Function Type

When storing a Graph & Table application function, the first thing you need to do is specify the function type. The following table lists all of the function types that you can select.

$y =$	Rectangular coordinate expression
$r =$	Polar coordinate expression
$xt/yt =$	Parametric expressions
$x =$	X = expression
$y >$ $y <$ $y \leq$ $y \geq$ $x >$ $x <$ $x \leq$ $x \geq$	Inequality
y 	Two functions in a list with shading between them

• **ClassPad Operation**



- (1) On the application menu, tap  .
- (2) On the Graph Editor window, tap the down arrow next to “y =”, or tap [Type].
- (3) On the list that appears, tap the function type you want to select.

Storing a Function

This section presents a number of examples that illustrate how to store a Graph & Table application function.



• **To store a rectangular coordinate function (Y=)**

Example: To store the rectangular coordinate function $y = 2x^2 - 5$ in line number y1

- (1) On the Graph Editor window, tap [Type] and then [y=Type] to specify a rectangular coordinate expression.
- (2) Tap the box to the right of line number “y1”, and then input the expression:
 .
- (3) Press  to store the expression.

• **To store a polar coordinate equation (r=)**

Example: To store the polar coordinate equation $r = 5\sin 3\theta$ in line number r2



- (1) On the Graph Editor window, tap [Type] and then [r=Type] to specify a polar coordinate expression.
- (2) Tap the box to the right of line number “r2”, and then input the expression:
 .
- (3) Tap  to store the expression.

• **To store parametric functions**

Example: To store the parametric functions below in line numbers xt3/yt3

$$x_t = 3\sin t$$

$$y_t = 3\cos t$$

- (1) On the Graph Editor window, tap [Type] and then [ParamType] to specify parametric expressions.
- (2) Tap the box to the right of line number “xt3”, and then input the x -expression:
 .
- (3) Tap the box to the right of line number “yt3”, and then input the y -expression:
 .

• **To store an $x =$ equation**

Example: To store $x = 3y$ in line $x4$

- (1) On the Graph Editor window, tap [Type] and then [$x=$ Type] to specify an $x =$ equation.
- (2) Tap the box to the right of line number “ $x4$ ”, and then input the equation: $\textcircled{3} \textcircled{y}$.
- (3) Press $\textcircled{\text{EXE}}$ to store the equation.

• **To store an inequality**

Example: To store the inequality $y > x^2 - 2x - 6$ in line $y5$

- (1) On the Graph Editor window, tap [Type] and then [$y>$ Type] to specify an inequality expression.
- (2) Tap the box to the right of line number “ $y5$ ”, and then input the expression: $\textcircled{x} \textcircled{\wedge} \textcircled{2} \textcircled{-} \textcircled{2} \textcircled{x} \textcircled{-} \textcircled{6}$.
- (3) Press $\textcircled{\text{EXE}}$ to store the expression.

• **To store a shade type ($y \spadesuit$)**

Example: To store $f(x) = x^2 - 1$, $g(x) = -x^2 + 1$, $-1 < x < 1$ in line $y6$

- (1) On the Graph Editor window, tap [Type] and then [ShadeType] to specify a shade type expression.
- (2) Tap the box to the right of line number “ $y6$ ”, and then input the expression:
 $\text{Keyboard} \textcircled{\text{mth}} \textcircled{\{}$ $\textcircled{x} \textcircled{\wedge} \textcircled{2} \textcircled{-} \textcircled{1} \textcircled{,}$ $\textcircled{-} \textcircled{x} \textcircled{\wedge} \textcircled{2} \textcircled{+} \textcircled{1} \textcircled{\}}$ $\textcircled{\text{OPTN}}$ $\textcircled{1} \textcircled{-}$
 $\textcircled{1} \textcircled{<} \textcircled{x} \textcircled{<} \textcircled{1}$
- (3) Press $\textcircled{\text{EXE}}$ to store the expression.

Tip

- An error message appears if you enter an expression that does not fit the function type. Either input the new function into a different line or delete the current function and then change the type before re-inputting the function.
- You can change the equality/inequality sign of an x -type ($x =, x >, x <, x \geq, x \leq$) or y -type ($y =, y >, y <, y \geq, y \leq$, ShadeType) expression after you input it. Simply tap the current equality/inequality sign.

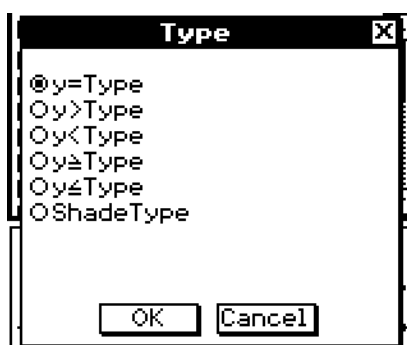

On the Type dialog box that appears, select the sign you want and then tap [OK].

Using Built-in Functions

Your ClassPad is pre-programmed with the commonly used functions listed below. You can recall a built-in function, save it to an Graph Editor sheet, assign values to its coefficients, and graph the results.

$$y = a \cdot x + b$$

$$y = a \cdot x^2 + b \cdot x + c$$

$$y = a \cdot x^3 + b \cdot x^2 + c \cdot x + d$$

$$y = a \cdot \sin (b \cdot x + c) + d$$

$$y = a \cdot \cos (b \cdot x + c) + d$$

$$y = a \cdot \tan (b \cdot x + c) + d$$

$$y = a \cdot \log (b \cdot x + c) + d$$



$$y = a \cdot \ln (b \cdot x + c) + d$$

$$y = a \cdot e^{(b \cdot x + c)} + d$$

$$y = a^{(b \cdot x + c)} + d$$

$$y = a / (b \cdot x + c) + d$$

• ClassPad Operation

- (1) On the application menu, tap  .
- (2) On the Graph Editor window, select the sheet and the line where you want to store the built-in function.
- (3) Tap  and then [Built-In].
- (4) On the menu that appears, tap the built-in function you want to select.
 - This displays a dialog box for assigning values to the coefficients. The actual coefficients that appear (a through d) depend on the built-in function you selected.
- (5) Assign values to each coefficient.
- (6) Tap [OK].



Saving the Message Box Expression to the Graph Editor Window

You can save the expression currently displayed in the Graph window message box to the Graph Editor window. This capability comes in handy when you want to save an expression that appears in the message box while you are using the sketch function (see “3-6 Using the Sketch Menu”).

Note

- The following are the steps you should perform after an expression is stored in the message box of the Graph window.

• **To save an expression from the message box to the Graph Editor window**

- (1) Tap the Graph window to make it active.
- (2) Perform a Trace operation (see “3-7 Using Trace”) or any other operation that causes the message box to appear.
- (3) Tap inside the message box to select the entire expression or drag the stylus across the part of the expression you want to select.
- (4) Tap .
- (5) Tap the Graph Editor window to make it active.
- (6) Select the sheet and tap the line where you want to save the expression, which moves the cursor there.
- (7) Tap [Edit] and then [Paste].
- (8) Press  to store the expression.

Tip



- You can also drag the expression from the message box to the Graph Editor window. In this case, you must drop the expression into a line on the Graph Editor window that does not already contain an expression.

Editing Stored Functions

• **To edit a function**

Example: To edit the function $y = x^2 - \frac{1}{3}x^3$ stored in line y2 of the Graph Editor to

$$y = x^2 - \frac{2}{3}x^3$$

- (1) On the Graph Editor window, tap line y2.
- (2) Tap the area immediately to the right of the numerator of $\frac{1}{3}$ so the cursor is located there.
- (3) Press  and then  to edit the fraction.
- (4) Press  to store the edited version of the function.

• **To delete a function**

- (1) On the Graph Editor window, select the sheet that contains the function you want to delete.
- (2) Tap the function you want to delete so the cursor is located anywhere inside it.
- (3) Tap [Edit] and then [Select All].
- (4) Press .
 - This deletes the selected function.

Deleting All Graph Editor Expressions

Use the following procedure to delete all of the expressions on all Graph Editor sheets, and initialize all of the sheet names.

- (1) On the Graph Editor window, tap [Edit] and then [Clear All].
- (2) In response to the confirmation dialog box that appears, tap [OK] to delete all expressions and initialize sheet names. To cancel the operation without deleting or initializing anything, tap [Cancel].

Graphing a Stored Function

You can select multiple functions and graph them simultaneously, as long as all of the functions are on the same sheet. You can turn graphing of each function on or off, and even specify the line style to be used for each function.

• ClassPad Operation

- (1) Tap the tab of the sheet that contains the functions you want to graph to make it active.
 - If the functions you want to graph are on Sheet 2, for example, tap the [Sheet2] tab.
- (2) Select the check boxes of all the functions you want to graph, and clear the check boxes of all the functions you do not want to graph.
 - See “Specifying the Function You Want to Graph” on page 3-3-8 for more information.
- (3) You can tap the current line style given to specify another style, if you want.
 - See “Specifying the Graph Line Style” on page 3-3-8 for more information.
- (4) Tap  to graph.

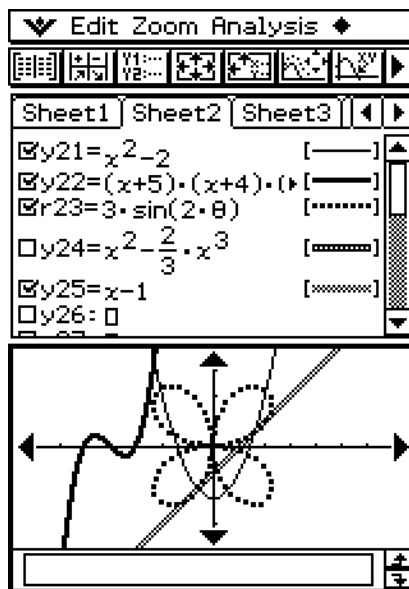

■ Specifying the Function You Want to Graph

On the Graph Editor window, you can select one or more functions for graphing by selecting their check boxes. The functions whose check boxes are cleared are not graphed.

- This check box is selected, so the function next to it will be graphed when you tap . If you do not want to graph this function, tap the check box to clear it.
- Each time you tap a check box, it toggles between being selected (checked) and cleared (unchecked).

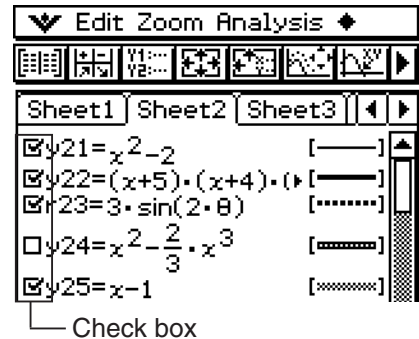

■ Specifying the Graph Line Style

You can specify one of the six line styles shown below for each function on the Graph Editor window.

- Normal [———]
- Thick [————]
- Broken Thick..... [.....]
- Square Plot Type [■ ■ ■ ■]
- Cross Plot Type [x x x x]
- Dot Plot Type [.....]

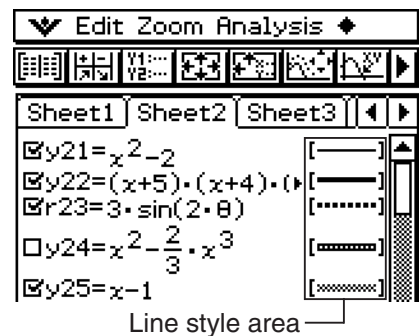

The currently selected line style appears in the line style area next to each function.

● ClassPad Operation

- (1) Tap the line style next to the function whose line style you want to specify. This displays the Graph Plot Type dialog box.

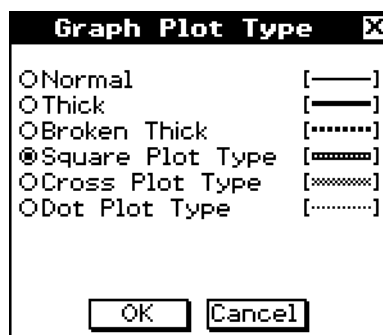

- (2) Select the line style you want, and then tap [OK].

- A preview of the line style you select appears in the line style area next to the function.
- To graph the function using the selected line style, tap .

Tip

- For an inequality region, the selected line style is used as the shading pattern.

■ Quick Graphing of an Expression Using Drag and Drop

You can use the following procedure to graph a single function, even when you have multiple functions selected on the Graph Editor window.

● ClassPad Operation

- (1) Tap the tab of the sheet that contains the function you want to graph to make it active.
- (2) Drag the function you want to graph to the Graph window.

Tip

- The above drag and drop procedure can be used to graph a function, regardless of whether the function's check box is selected or cleared.
- When you quick graph a function using drag and drop, the function is always treated as a "y=" expression, regardless of the graph type specified for the function.
- Up to 30 of the graphs you draw in the Graph window are stored in memory as you draw them. This includes graphs drawn from Graph Editor window functions, graphs drawn using the Sketch functions (Tangent, Normal, Inverse), and graphs drawn using the drag and drop operation described above. Though you can draw more than 30 graphs at one time, any graphs after the 30th are not stored in memory.
- All of the Graph window graphs that are currently stored in memory are redrawn when you scroll the Graph window or tap the [ReDraw] command on the  menu. Since only 30 graphs are stored in memory, anything drawn after the 30th graph is not redrawn. Keep this limitation in mind when you draw a large number of graphs at the same time.

■ Overlaying Two Inequalities in an AND Plot / OR Plot

Use the following procedure to overlay two inequalities in an AND Plot or OR Plot which are described below.

- AND Plot
With an AND Plot, only the parts of the inequalities that overlap are shaded.
- OR Plot
With an OR Plot, the inequalities are overlaid as they are.

Example: To graph the inequalities $y < x^2$, $y \leq x + 1$

● ClassPad Operation

- (1) Store $y < x^2$ in line y1 and $y \leq x + 1$ in line y2.
- (2) On the  menu, tap [Inequality Plot].
Select [and] or [or] on the submenu that appears.

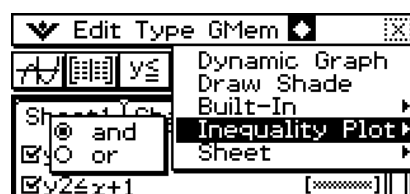

3-3-10
Storing Functions

(3) Tap .

AND Plot

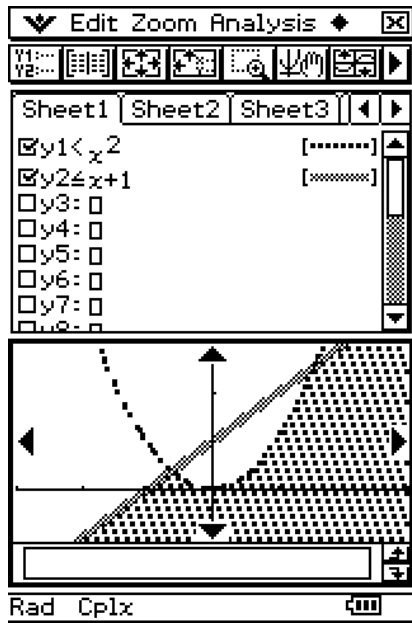

OR Plot

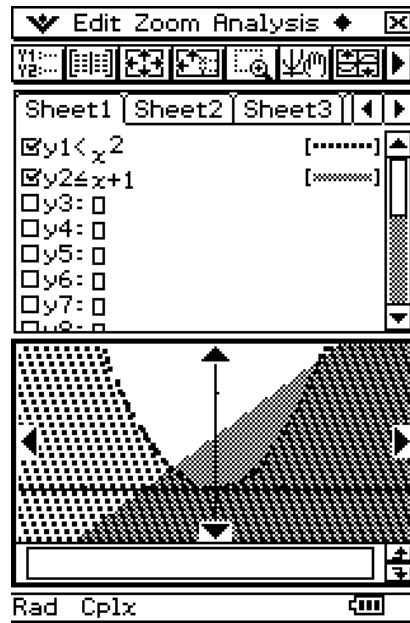

■ Shading the Region Bounded by Two Expressions

You can shade the region bounded by two expressions by specifying [ShadeType] as the function type and then inputting the expressions in the syntax shown below.

Syntax: $y \blacklozenge \{ \text{lower function } f(x), \text{ upper function } g(x) \} | A < x < B$

The value of B must be greater than A.

- $A < x < B$ can be omitted.
- $A < x < B$ can be replaced with $x > A$.
- $A < x < B$ can be replaced with $x < B$.

Example: To graph $f(x) = x^2 - 1$, $g(x) = -x^2 + 1$, $-1 < x < 1$

● ClassPad Operation

- (1) On the Graph Editor Window, tap [Type] and then [ShadeType].
- (2) Store $y \blacklozenge \{ x^2 - 1, -x^2 + 1 \} | -1 < x < 1$ in line y1.
- (3) Tap \boxed{A} .

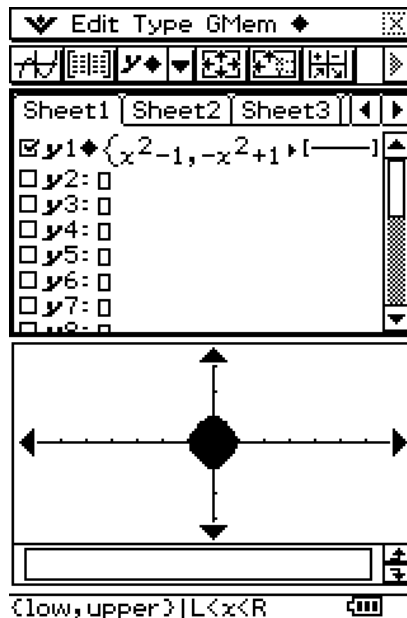

- When [ShadeType] is selected as the function type, the status bar displays “{low, upper} | $L < x < R$ ”.

■ Using the Draw Shade Dialog Box to Shade the Region Bounded by Two Expressions

In this case, you input the expressions on a Draw Shade dialog box instead of the Graph Editor Window.

Example: To graph $f(x) = -1$, $g(x) = 1$, $-1 < x < 1$

● ClassPad Operation

(1) On the  menu, tap [Draw Shade].

- This displays the Draw Shade dialog box.

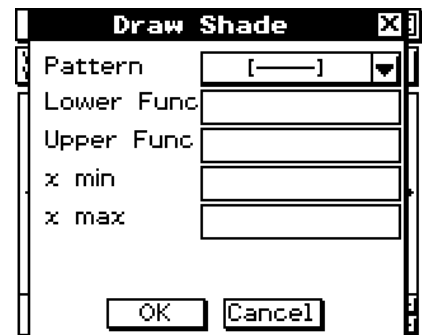

Pattern	Select the shading pattern.
Lower Func	Input the lower function $f(x)$.
Upper Func	Input the upper function $g(x)$.
x min	Specify the lower limit of the shaded region.
x max	Specify the upper limit of the shaded region.

(2) Input the following: Lower Func: -1 , Upper Func: 1 , x min: -1 , x max: 1

(3) Tap [OK].

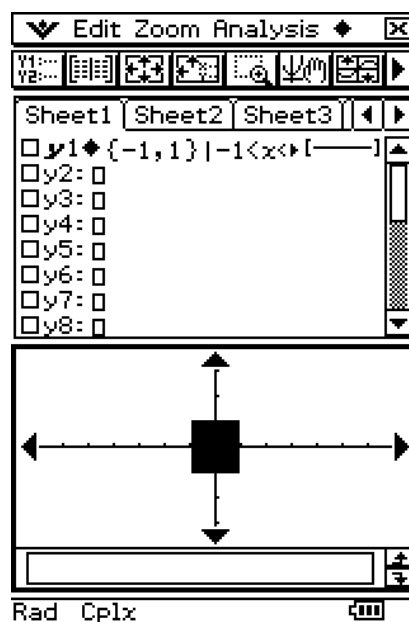

■ Dropping an Expression from the Main Application Work Area into the Graph Window

- You can graph a polar coordinate expression by dragging it from the Main Application work area and dropping it into the Graph window.

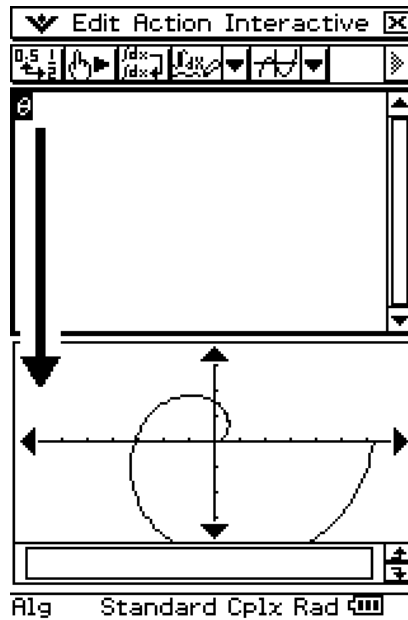

- If there are multiple expressions in the same Main Application work area line, all of the expressions will be graphed when you drop the line into the Graph window.

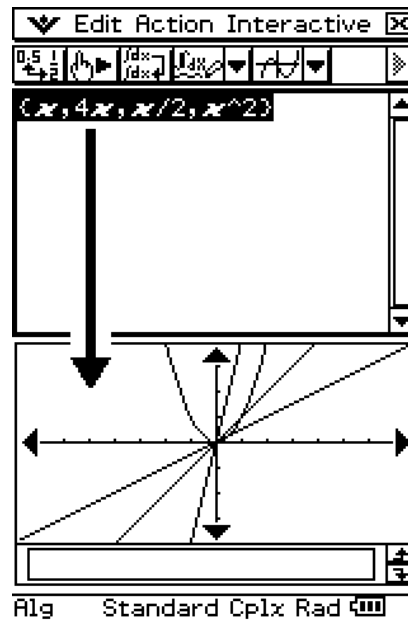

Saving Graph Editor Data to Graph Memory

Graph memory lets you store all of the expressions and their related information to a file for later recall.

Each graph memory file contains the following data:

- Functions on all five Graph Editor sheets (up to 100 functions)
- Whether the check box next to each function is selected (checked) or cleared (unchecked)
- The line style of each function
- The graph type of each function
- The View Window settings
- Which sheet is currently active
- Sheet names

• To save Graph Editor data to graph memory

- (1) Tap the Graph Editor window to make it active.
- (2) Tap [GMem] and then [Store]. This displays a dialog box for inputting a name for the graph memory file.
- (3) Enter the name and then tap [OK].

• To recall a graph memory file

- (1) Tap [GMem] and then [Recall]. This displays a list of names of graph memory files you have stored in memory.
- (2) Select the name of the graph memory file you want, and then tap [OK].



3-4 Using Table & Graph

The Graph & Table application includes a “Table window” for displaying number tables and summary tables generated with the functions you input on the Graph Editor window.



Generating a Number Table

You can use either of the following two methods to generate a number table using a Graph & Table application function. The method used to generate the number table depends on the setting of the Graph Format dialog box [Table Variable] item.

- For details about Graph Format settings, see “Application Format Settings” on page 1-9-4.

- **Specifying a range of values for x using the Table Input dialog box**

This is the initial default number table generation method. With this method, you use the Table Input dialog box to specify a range of values for variable x , and then generate a number table for those values. This number table generation method is in effect whenever “Table Input” is selected for the [Table Variable] setting.

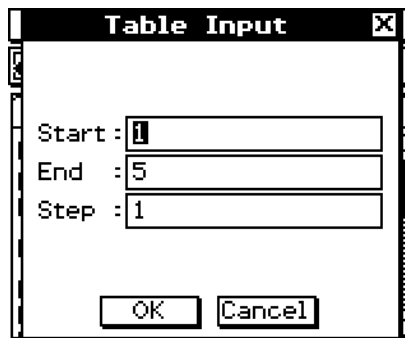

- **Assigning list values to x**

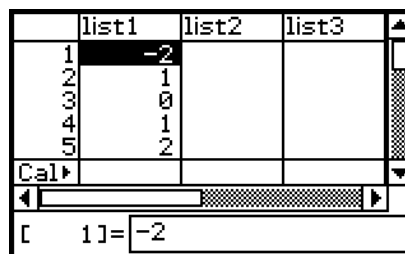

With this number table generation method, you must first use the Stat Editor to create a list and store the list data. To access the Stat Editor, tap  and then [Stat Editor].





For details about using the Stat Editor, see Chapter 7.

- To generate a number table by specifying a range of values for x using the Table Input dialog box

Example: To generate a number table for the function $y = 3x^2 - 2$ as the value of x changes from -3 to 1 in increments of 1

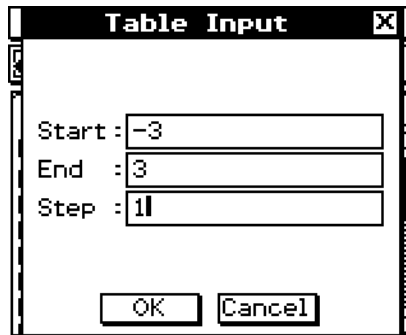
- (1) On the application menu, tap .
- (2) In line y_1 of the Graph Editor window, input and save $y = 3x^2 - 2$.
- (3) Tap . This displays the Table Input dialog box.
- (4) Input the following values for the x -values of your table, and then tap [OK].



- (5) Tap .
 - This generates the number table and displays the result on the Table window.

x	y1
-3	25
-2	10
-1	1
0	-2
1	1

x	y1	y'1
-3	25	-18
-2	10	-11.99
-1	1	-6
0	-2	0
1	1	6

- The derivative is also included in the number table when the Graph Format “Derivative/Slope” check box is selected.

Tip

- The above operation is possible only when “Table Input” (which is the initial default) is selected for the Graph Format dialog box [Table Variable] item.
- You can specify the width of table cells using the [Cell Width Pattern] on the Graph Format dialog box (page 1-9-6).

• **To generate a number table by assigning list values to x**

(1) Create and save the list of values to be assigned.

list1 = 1, 2, 3, 4, 5

(2) In line y1 of the Graph & Table application Graph Editor window, input and save $y = 3x^2 - 2$.

(3) Specify the list that contains the values you want to assign to x (list1 in this example).

- You can configure list data settings using the Graph Format dialog box.
For details about Graph Format settings, see “Application Format Settings” on page 1-9-4.

(4) On the Graph Editor window, tap the function you want to use for number table generation (y1 in this example).

(5) Tap .

- This generates the number table and displays the result on the Table window.

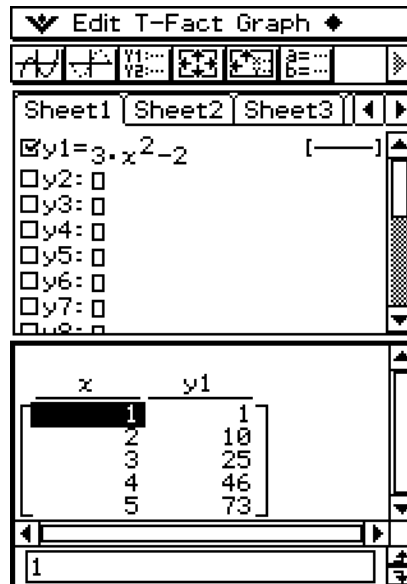

Tip

- The above operation is possible only when “List” (list1 through list6 or a list variable created by you) is selected for the Graph Format dialog box [Table Variable] item. Note that “Table Input” is the default, so you need to change the [Table Variable] setting in order to generate a table using list values.

Table Generation Precautions

- Table generation is performed using the currently selected function that is of the current function type selected on the Graph Editor window toolbar.

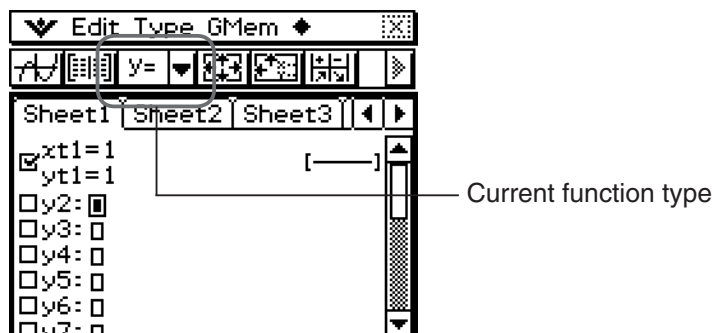

- Though the selected current function type is “y=” in the above screenshot, there is no “y=” type function selected on the Graph Editor window. Tapping to generate a table when the above condition exists causes the error message “No Item(s) Checked” to appear.
- An inequality cannot be used to generate a table.

Editing Number Table Values

Changing an x -value in the number table automatically calculates and displays the corresponding y -value.

Example: To change the x -value in line 3 of the number table from -1 to -2.5
To generate a table, see “To generate a number table by specifying a range of values for x using the Table Input dialog box” on page 3-4-2.

ClassPad Operation

- Tap the cell in line 3 of column x of the number table to select it.

x	$y1$
-3	25
-2	10
-1	1
0	-2
1	1

- Perform the key operation: \ominus 2 \odot 5 .

- Pressing \ominus causes the Enter Value dialog box to appear with a minus sign ($-$) in the [x -value] input box. Continue with the rest of the key operation to input the required value, and then tap [OK]. This changes the value in the selected cell to the one you input.

x	$y1$
-3	25
-2	10
-2.5	16.75
0	-2
1	1

The y -value is updated automatically in accordance with the new x -value.

Tip

- An error message appears and the number table contents are not changed if you enter an illegal value for x (such as $6 \div 0$).
- The data in a “Y” column (Y1, Y2, etc.) of a table cannot be modified.



Deleting, Inserting, and Adding Number Table Lines

You can use the following procedures to delete, insert, and add number table lines.

• To delete a number table line

(1) Tap the x -value of the line you want to delete.

This line will be deleted.

x	$y1$
-3	25
-2	10
-1	1
0	-2
1	1

(2) Tap [T-Fact] and then [Delete].

x	$y1$
-3	25
-1	1
0	-2
1	1
2	10

• To insert a number table line

(1) Tap the x -value of the line below the location where you want to insert a line.

The line will be inserted here.

x	$y1$
-3	25
-2	10
-1	1
0	-2
1	1

(2) Tap [T-Fact] and then [Insert].

Inserted line
The new line contains the same values as the one you selected in step (1).

x	$y1$
-3	25
-2	10
-2	10
-1	1
0	-2

- After inserting a new line, you can edit the x -value, if you want. For more information, see “Editing Number Table Values” on page 3-4-4.

• **To add a number table line**

(1) Tap the x -value of the bottom line of the number table.

x	y_1
-1	1
0	-2
1	1
2	10
3	25

(2) Tap [T-Fact] and then [Add].

Added line
The new line contains the same values as the bottom line of the number table.

x	y_1
0	-2
1	1
2	10
3	25
3	25

- After adding a new line, you can edit the x -value, if you want. For more information, see “Editing Number Table Values” on page 3-4-4.
- You can add a line anywhere. When you add a line, it will appear after the line you selected.

Regenerating a Number Table





After changing [Table Input] settings, you can regenerate a table based on the new settings by tapping  and then [ReTable]. You can also use [ReTable] after editing the contents of a table to return the table to its original (pre-edited) state.

Generating a Number Table and Using It to Draw a Graph

After using a function to generate a number table, you can use the number table values to draw a graph. You can use number table values to draw two different types of graphs: a “connect type graph” on which points are connected by lines, or a “plot type graph” on which points are simply plotted, without being connected.

Example: To generate number tables for the functions $y = 3x^2 - 2$ and $y = x^2$ as the value of x changes from -3 to 3 in increments of 1 , and then use the generated values to draw a graph

• ClassPad Operation

- (1) On the application menu, tap  .
- (2) On the Graph Editor window, input $3x^2 - 2$ in line y_1 , and x^2 in line y_2 .
- (3) Tap  to display the View Window dialog box, and then configure it with the following parameters.
 $x_{\min} = -3$, $x_{\max} = 3$, $x_{\text{scale}} = 1$
 $y_{\min} = -2$, $y_{\max} = 10$, $y_{\text{scale}} = 2$
- (4) Tap  to display the Table Input dialog box, and then configure it with the following settings.
 Start: -3 , End: 3 , Step: 1
- (5) Tap  .
 - This generates the number table and displays the result on the Table window.

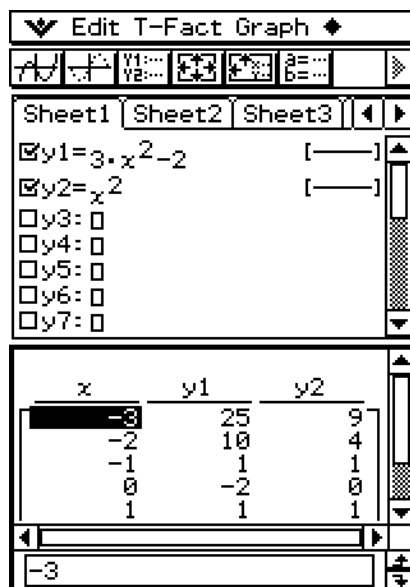



The screenshot shows the ClassPad interface. At the top is a title bar 'Edit T-Fact Graph' with a dropdown arrow. Below it is a toolbar with various icons. The main area is divided into two sections. The upper section is a list of functions: 'y1=3·x²-2', 'y2=x²', and several empty 'y3' through 'y7' entries, each with a checkbox and a small graph icon. The lower section is a table with three columns labeled 'x', 'y1', and 'y2'. The table contains the following data:

x	y1	y2
-3	25	9
-2	10	4
-1	1	1
0	-2	0
1	1	1

At the bottom of the screen, there is a small input field containing the value '-3'.

(6) Specify the graph type.

- To specify a connect type graph, tap [Graph] and then [G-Connect], or tap . To specify a plot type graph, tap [Graph] and then [G-Plot], or tap .
- This draws the graph on the Graph window.

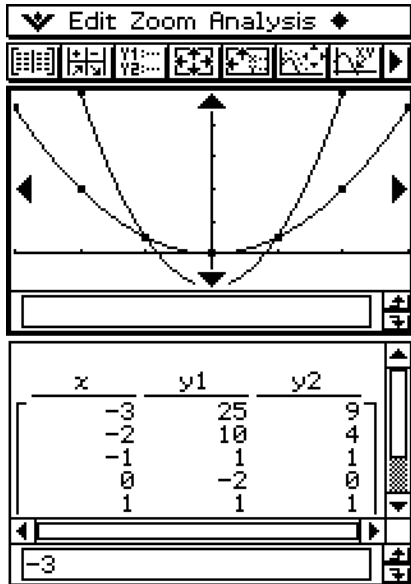

Connect Type Graph

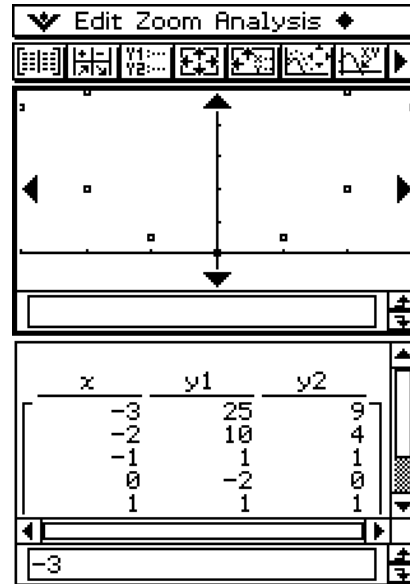

Plot Type Graph

Saving a Number Table to a List

You can use the following procedure to save a particular column of a number table to a LIST variable.

• ClassPad Operation

(1) On the Table window select any cell in the column you want to save to a LIST variable.

- To save column y1 in the window shown below, for example, select any cell in column y1.

x	y1	y2
-3	25	9
-2	10	4
-1	1	1
0	-2	0
1	1	1

25

(2) Tap  and then [Table to List].

- This displays a dialog box for specifying a variable name.



(3) Enter the name you want to give to the variable, and then tap [OK].

- This assigns the list of data you selected to a variable with the name you specified.
- If the variable name you input has not been used yet for another variable, ClassPad creates a new variable. With some data types, if the variable name you input is already being used for an existing variable, the existing variable is replaced by the new one. For more information, see “Variable Data Types” on page 1-7-3.

Generating a Summary Table

You can use any of the three methods described below to generate a summary table from a function that has already been saved.

- **Automatic x -value settings**

This method automatically generates an ideal summary table for the function. This method uses View Window settings when generating the table.

- **Using View Window x_{min} and x_{max} values as the x -value settings**

With this method, you simply provide the upper and lower x -value limits, and your ClassPad generates the correct summary table for that range of values. This method uses View Window settings when generating the table.

• **Specifying all x -values**

This method generates a reference table by looking up data stored in a list. A LIST variable is used to specify the x -values. When using this method, it is up to you specify all of the correct x -values required to generate the summary table. The summary table will not be generated correctly if you provide incorrect x -values.

The following shows examples of each of the three available summary table generation methods by generating a table for the function $y = x^3 - 3x$.

x	-1	0	1
$f'(x)$	+	0	-
$f''(x)$	-	-6	-
$f(x)$	\curvearrowright	2	\curvearrowleft

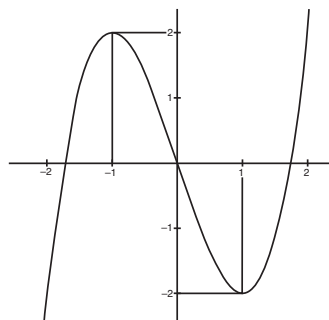

Summary Table and Graph of $y = x^3 - 3x$
(The graph to the right is for reference only.)

Tip

- You can control whether or not the summary table should include an $f''(x)$ line (quadratic differential component) using the [Summary Table $f''(x)$] setting on the [Special] tab of the Graph Format dialog box (page 1-9-7). Turning on the [Summary Table $f''(x)$] option causes both linear differential components and quadratic differential components to be displayed in the summary table. Turning it off shows linear differential components only.

■ **Generating a Summary Table Using Automatically Set x -Values**

With this method, the summary table is generated using a range of values from $-\infty$ to ∞ .

• **ClassPad Operation**

- (1) On the Graph Format dialog box, select “View Window” for the [Summary Table] setting, and specify the value you want for [Cell Width Pattern]. This example uses a [Cell Width Pattern] setting of “4 Cells”.
 - To open the Graph Format dialog box, tap , and then [Graph Format].
 - For additional details about Graph Format settings, see “Application Format Settings” on page 1-9-4.
- (2) Input the function $y = x^3 - 3x$ on the Graph Editor window.
 - Generation of summary tables is supported for “ $y=$ ” type functions only.
 - Clear the check boxes of all other functions on the Graph Editor window, if necessary. Select the check box next to $y = x^3 - 3x$ and press **EXE**.
 - If the check boxes of more than one “ $y=$ ” type functions are selected, the one with the lowest line number (y_1, y_2, y_3 , etc.) is used for number table generation.
- (3) Tap to display the View Window dialog box.

3-4-11
Using Table & Graph

(4) Tap [Memory] and then [Auto].

- This causes all settings on the View Window dialog box to change to “Auto”.

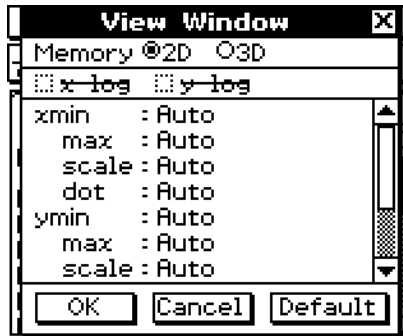

(5) Tap the [OK] button to close the View Window dialog box.

(6) Tap  to toggle to toolbar 2 and then tap .

- This starts summary table generation, and displays the result on the Table window. Note that generation of a summary table can take a bit of time.

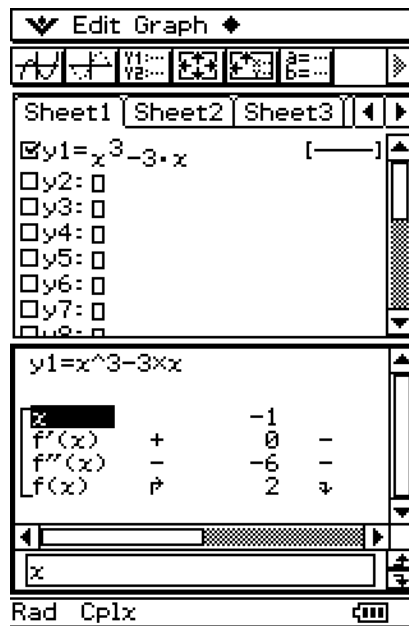

- You can scroll the window to view all of the contents of the table.

x		-1		0		1	
f'(x)	+	0	-	-3	-	0	+
f''(x)	-	-6	-	0	+	6	+
f(x)	↑	2	↓	0	↓	-2	↑

- Tapping  here graphs the function using the View Window settings automatically configured for summary table generation.

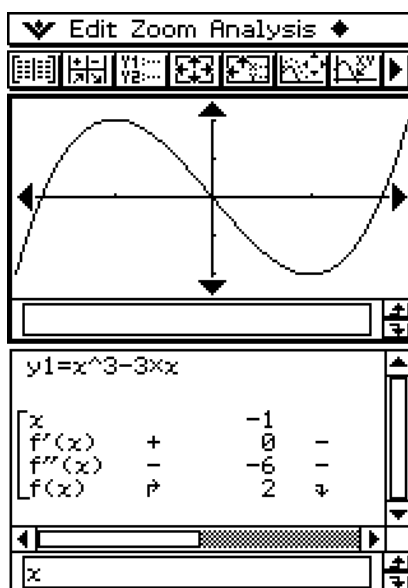

Important!

- A monotone increasing function or other special function may not be solvable by the ClassPad's internal summary table calculation. If this happens, use the procedure under "Generating a Summary Table by Specifying All of the Values for x " (page 3-4-14) to calculate the elements of the summary table. In addition to View Window parameters, you can also select previously stored list data to specify the range of a summary table. On the Graph Format dialog box (displayed using the  menu), select the [Special] tab, tap the "Summary Table" down arrow button, and then select the name of the list you want to use on the menu that appears.
- If you draw a graph or generate a summary table while "Auto" is specified for View Window parameters, the ClassPad calculates appropriate parameters and configures View Window settings accordingly.

■ Generating a Summary Table Using View Window

With this method, the summary table is generated using the range you define for the View Window "xmin" and "xmax" parameters.

• ClassPad Operation

- (1) On the Graph Format dialog box, select "View Window" for the [Summary Table] setting, and specify the value you want for [Cell Width Pattern]. This example uses a [Cell Width Pattern] setting of "4 Cells".
 - For details about Graph Format settings, see "Application Format Settings" on page 1-9-4.
- (2) Input the function $y = x^3 - 3x$ on the Graph Editor window.
 - Generation of summary tables is supported for "y=" type functions only.
 - Clear the check boxes of all other functions on the Graph Editor window, if necessary. Select the check box next to $y = x^3 - 3x$ and press .
 - If the check boxes of more than one "y=" type functions are selected, the one with the lowest line number (y_1 , y_2 , y_3 , etc.) is used for number table generation.

(3) Tap  to display the View Window dialog box.

(4) Specify the x -values for the summary table by specifying values for the [xmin] and [xmax] settings.

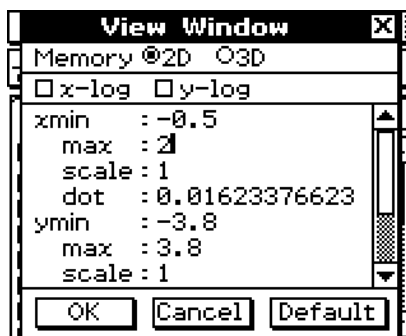

- For this example, we will specify $x_{min} = -0.5$ and $x_{max} = 2$.

(5) Tap the [OK] button to close the View Window dialog box.

(6) Tap .

- This starts the summary table generation using the range you specified in step (4), and displays the result on the Table window.

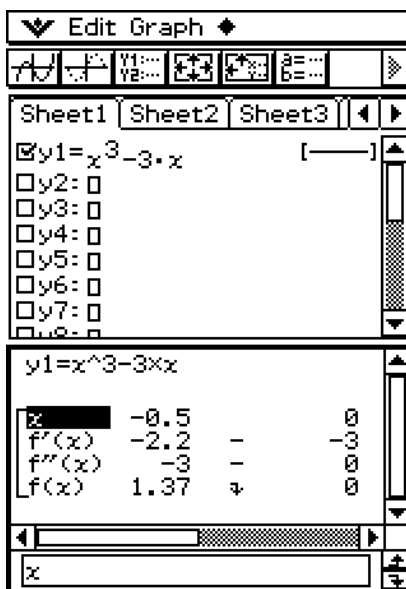

Important!

- A monotone increasing function or other special function may not be solvable by the ClassPad's internal summary table calculation. If this happens, use the procedure under "Generating a Summary Table by Specifying All of the Values for x " (page 3-4-14) to calculate the elements of the summary table. In addition to View Window parameters, you can also select previously stored list data to specify the range of a summary table. On the Graph Format dialog box (displayed using the  menu), select the [Special] tab, tap the "Summary Table" down arrow button, and then select the name of the list you want to use on the menu that appears.

■ Generating a Summary Table by Specifying All of the Values for x

In both of the previous examples, summary table generation is performed using View Window settings to calculate values for x that satisfy the function $f'(x) = 0$. With this table generation method, x -values are not calculated automatically.

It is up to you to use a LIST variable to specify all of the x -values that appear in the summary table.

In the example below, x -values will be stored in a LIST variable named “list1”, which is then used to generate a summary table.

• ClassPad Operation

- (1) On the Graph Format dialog box, select “list1” for the [Summary Table] setting, and specify the value you want for [Cell Width Pattern]. This example uses a [Cell Width Pattern] setting of “4 Cells”.
 - For details about Graph Format settings, see “Application Format Settings” on page 1-9-4.
- (2) Input the function $y = x^3 - 3x$ on the Graph Editor window.
 - Generation of summary tables is supported for “y=” type functions only.
 - Clear the check boxes of all other functions on the Graph Editor window, if necessary. Select the check box next to $y = x^3 - 3x$ and press EXE .
 - If the check boxes of more than one “y=” type functions are selected, the one with the lowest line number (y_1, y_2, y_3 , etc.) is used for number table generation.
- (3) Tap \blacktriangledown and then [Stat Editor] to display the Stat Editor window.

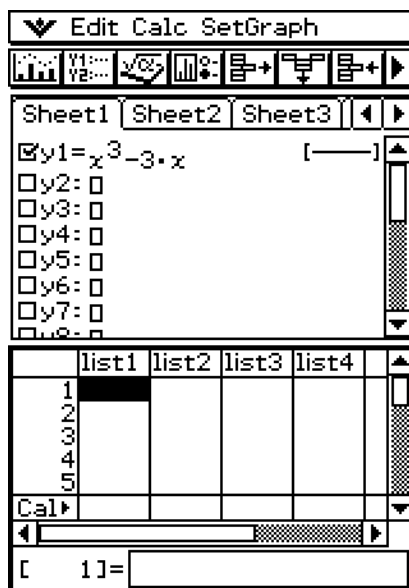

(4) Input the values you want to specify for x into list1.

- Here, we will input the following values: $x = -2, -1, 0, 1, 2$.

	list1	list2	list3	list4
2	-1			
3	0			
4	1			
5	2			
6				

Cal

[6] =

(5) Tap the Graph Editor window to make it active.

(6) Tap .

- This starts summary table generation using the x -values you input in step (4), and displays the result on the Table window.

Edit Graph

Sheet1 | Sheet2 | Sheet3

$y_1 = x^3 - 3 \cdot x$

$y_2 =$

$y_3 =$

$y_4 =$

$y_5 =$

$y_6 =$

$y_7 =$

$y_8 =$

$y_1 = x^3 - 3 \cdot x$

x		-2	
$f'(x)$	+	9	+
$f''(x)$	-	-12	-
$f(x)$	+	-2	+

x

Important!

- For the above method to correctly generate a summary table, you must have legal x -values in the list assigned to the LIST variable. Note that an error occurs if the specified LIST variable is empty or does not exist.
- Some functions may not be solvable by the ClassPad's internal summary table calculation. When this happens, the "Can't Solve!" error message appears on the display.

Making the Graph Editor Window the Active Window

While the Table window is active, you can make the Graph Editor window the active window by tapping anywhere inside of it or by tapping .

3-5 Modifying a Graph

A graph can be modified in real time as you change its coefficients and/or the variables. The Graph & Table application provides you with two methods for modifying a graph.

Direct Modify

“Direct Modify” changes the coefficient in the equation of the original graph. This method can be used when you are modifying a single graph.

Dynamic Modify

“Dynamic Modify” changes the values assigned to common variables of multiple functions. Use Dynamic Modify when you want to modify multiple graphs at the same time.

Modifying a Single Graph by Changing the Value of a Coefficient (Direct Modify)

Use the following procedure to change the values of the coefficients of a function within a specific range to find out the effect the change has on the shape or position of the graph.



- **To modify a single graph**

Example: To graph the functions $y = 2x^2 + 3x - 1$ and $y = 2x + 1$, and then find out how a change in the coefficients of each function affects the shape and position of the graphs

Note

- Before starting the following procedure, check the Graph Format dialog box to make sure that the [G-Controller] setting is turned on. For information about the Graph Format dialog box, see page 1-9-6.

- **ClassPad Operation**

- (1) On the application menu, tap  .
- (2) Configure View Window parameters.
- (3) On the Graph Editor window, input $2x^2 + 3x - 1$ in line y1, and $2x + 1$ in line y2.
- (4) Tap  to graph the functions.
- (5) Tap [Analysis] and then [Modify].
 - This displays a dialog box for inputting the step.

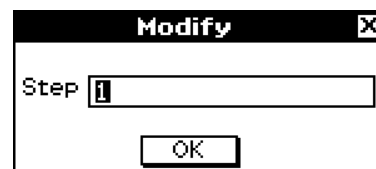

3-5-2
Modifying a Graph

(6) Input the amount of change (step) in the coefficient value, and then tap [OK].

- This causes “Modify” to appear on the Graph window and the y_1 graph ($2x^2 + 3x - 1$) to become active, which is indicated by a thick graph line.
- The function of the currently active graph is displayed in the Graph window message box.

(7) In the function displayed in the message box, select the coefficient you want to change.

(8) Tap the left or right graph controller button to change the value of the coefficient you selected in step (7).

To do this:	Do this:
Increase the value of the coefficient	Tap the right graph controller arrow.
Decrease the value of the coefficient	Tap the left graph controller arrow.

- You can use the Dynamic Graph dialog box on page 3-5-4 to change the increment, if you want.

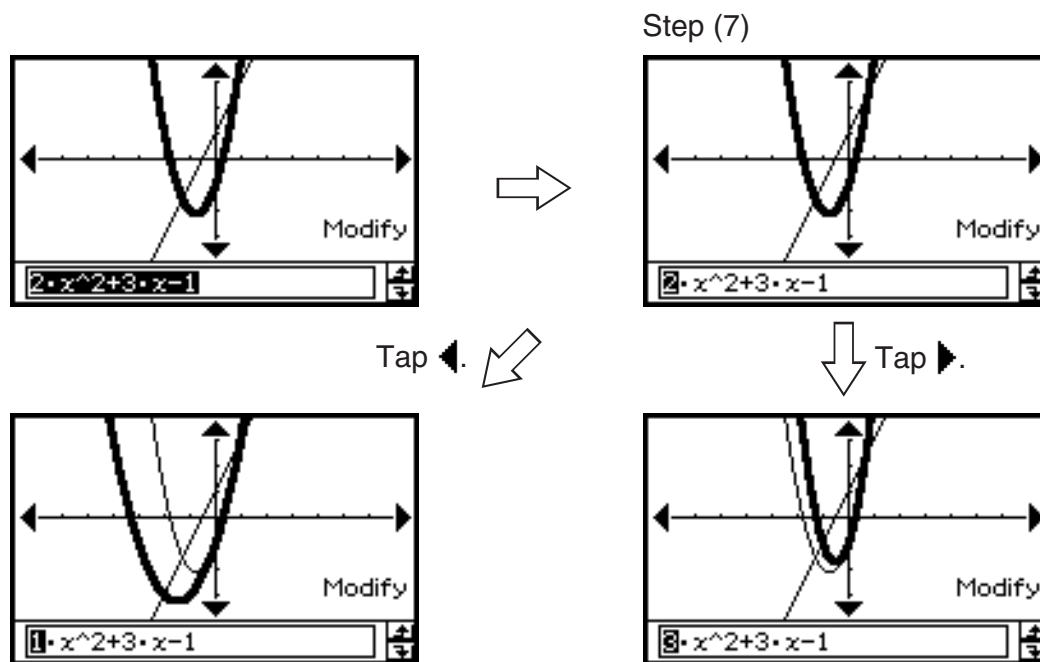

- At this point, you could select other coefficients and change their values as well, if you want.

Important!

- If display of the graph controller arrows is turned off, select the coefficient you want to modify, tap the Graph window with the stylus and then use the left and right cursor keys to change the coefficient value.
- When the graph controller is off and the entire expression is selected you can use the left and right cursor keys to change the modified graph.
- When the graph controller is on or off you can edit the expression directly and then press **EXE** to change the modified graph.

3-5-3
Modifying a Graph

(9) To modify the y_2 graph ($2x + 1$), tap the down graph controller arrow to make it the graph active.

- You can use the up and down cursor keys or graph controller arrows to switch between the two graphs, as required.
- Repeat steps (7) and (8) to modify the currently selected graph.

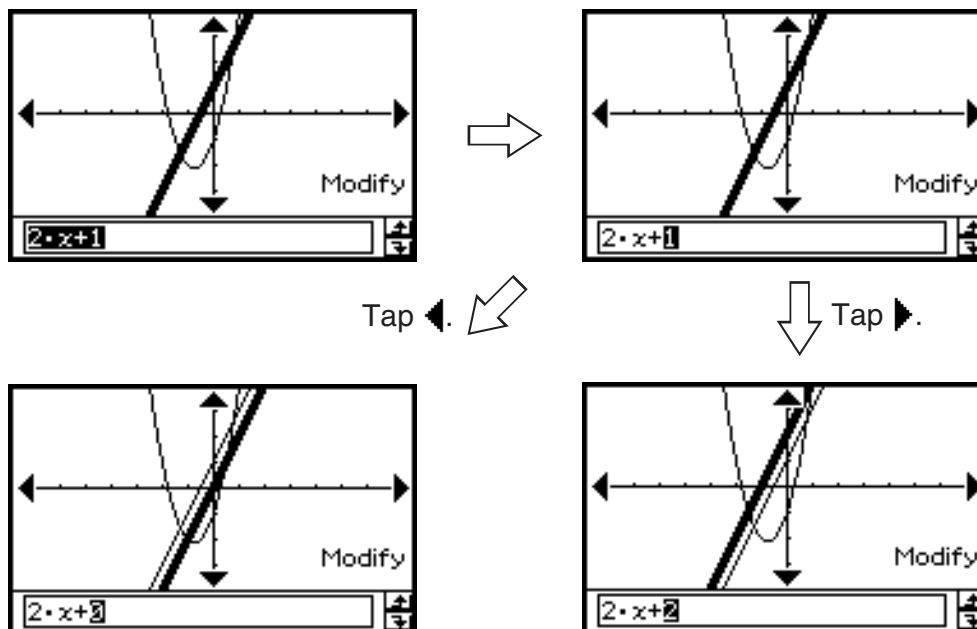

(10) To quit graph modification, tap **ESC** on the icon panel.

- This causes “Modify” to disappear from the display, returning to the normal Graph window.

Simultaneously Modifying Multiple Graphs by Changing Common Variables (Dynamic Modify)

Use the procedure below to change the values of up to two common variables used in multiple functions to simultaneously modify the graphs.

• To modify multiple graphs simultaneously

Example: To graph the functions $y = ax^2 - b$ and $y = ax + b$, and then find out how a change in variable a from 1 to 4 and a change in variable b from -2 to 2 affect the shape and position of each graph

(1) On the application menu, tap .

(2) Tap  and then [Main] to display the Main application window.

Tip

- For details about using the Main application, see Chapter 2.

(3) Use the Main application work area to assign values to variables “ a ” and “ b ” ($a = 1$ and $b = 2$ in this example).





(4) Tap  and then [Close] to close the Main application window.

(5) Configure View Window parameters.

(6) On the Graph Editor window, input $ax^2 - b$ in line $y1$, and $ax + b$ in line $y2$.

(7) Tap  to draw the graph.

(8) Tap  and then [Dynamic Graph]. This displays the Dynamic Graph dialog box.

(9) Configure the following settings on the Dynamic Graph dialog box.

Setting	Description
Dynamic ◀▶: a	Specifies a variable whose value is changed when you press the left or right cursor key, or tap the left or right graph controller arrow.
Start: 1	These items specify the upper limit (End) and lower limit (Start) of the range of change of the Dynamic ◀▶ value.
End: 4	
Step: 1	Use this setting to specify the increment of change in the Dynamic ◀▶ value when you press the left or right cursor key, or tap the left or right graph controller arrow.
Dynamic ▲▼: b	Specifies another variable whose value is changed when you press the up or down cursor key, or tap the up or down graph controller arrow.
Start: -2	These items specify the upper limit (End) and lower limit (Start) of the range of change of the Dynamic ▲▼ value.
End: 2	
Step: 1	Use this setting to specify the increment of change in the Dynamic ▲▼ value when you press the up or down cursor key, or tap the up or down graph controller arrow.

3-5-5
Modifying a Graph

(10) Tap [OK].

- This displays a WARNING! dialog box for overwriting variable a .



(11) Tap [OK].

- This displays a WARNING! dialog box for overwriting variable b .

(12) Tap [OK].

- This graphs the functions using the a and b variable start values you specified on the Dynamic Graph dialog box, and displays "Modify" on the Graph window.

(13) Modify the graphs by changing the value of variable a or b .

- To change the value of variable a , press the left or right cursor key, or tap the left or right graph controller arrow.
- To change the value of variable b , press the up or down cursor key, or tap the up or down graph controller arrow.

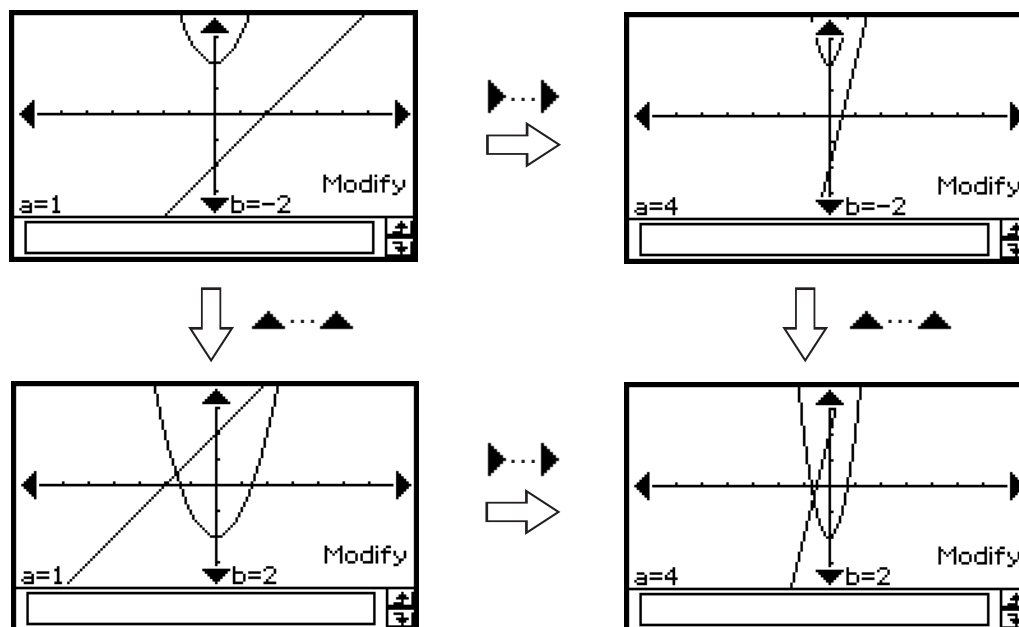

(14) To quit graph modification, tap **ESC** on the icon panel.

- This causes "Modify" to disappear from the display, returning to the normal Graph window.

■ Cycling Through Graph Changes Automatically

Use the following procedure to cycle automatically through graph changes in accordance with the settings you configure on the Dynamic Graph dialog box.

● ClassPad Operation

- (1) Perform steps (1) through (9) under “To modify multiple graphs simultaneously” on page 3-5-4.
- (2) On the Dynamic Graph dialog box, tap the [Auto] option.

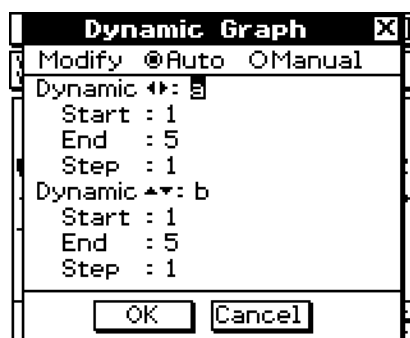

- (3) Tap [OK].
 - This graphs the functions using the a and b variable start values you specified on the Dynamic Graph dialog box, and displays “Modify” on the Graph window.
- (4) Execute an auto change operation.
 - To execute three cycles of an auto change operation for variable a , tap the right graph controller arrow.
 - To execute three cycles of an auto change operation for variable b , tap the up graph controller arrow.
- (5) To quit graph modification, tap **ESC** on the icon panel.
 - This causes “Modify” to disappear from the display, returning to the normal Graph window.

3-6 Using the Sketch Menu

The [Sketch] menu lets you add points, lines, figures, and text after you draw a graph. You can also add tangent and normal lines to your graph.

Sketch Menu Overview

To access the [Sketch] menu, tap [Analysis] and then [Sketch]. The following table describes the commands that are available on the [Sketch] menu.

To do this:	Select this Sketch menu command:
Clear figures and text you have added using the sketch feature	Cls
Plot a point on the Graph window	Plot
Draw a line on the Graph window	Line
Write text on the Graph window	Text
Draw a line that is tangent to a particular point on a graph	Tangent
Draw a line that is normal to a particular point on a graph	Normal
Graph the inverse of a function	Inverse
Draw a circle	Circle
Draw a vertical line	Vertical
Draw a horizontal line	Horizontal

Using Sketch Menu Commands

This section describes how to use each of the commands on the [Sketch] menu. Note that all of the procedures in this section are performed in the Graph & Table application, which you can enter by tapping the  icon on the application menu.

• To plot a point on the Graph window

- (1) While the Graph window is active, tap [Analysis], [Sketch], and then [Plot].
- (2) Tap the location on the Graph window where you want to plot a point.
 - Instead of tapping the Graph window, you could also use the keypad to specify the coordinates of the point. Pressing a number key displays a dialog box for inputting coordinates. The value of the key you just pressed is input for the x -coordinate. After inputting values for the x - and y -coordinates, tap [OK] to plot the point at the location you specified.

• **To draw a line on the Graph window**

- (1) While the Graph window is active, tap [Analysis], [Sketch], and then [Line].
- (2) On the Graph window, tap the start point of the line and then tap the end point. This causes a straight line to be drawn between the two points. The message box shows the equation of the line.
 - Instead of tapping the Graph window, you can use the keypad to specify the coordinates of the start point and end point. Pressing a number key displays a dialog box for inputting coordinates. The value of the key you just pressed is input for the x -coordinate of the starting point. After inputting values for the x - and y -coordinates of the start point (x_1, y_1) and the x - and y -coordinates of the end point (x_2, y_2), tap [OK] to draw a straight line between the two points you specified.

• **To write text on the Graph window**

- (1) While the Graph window is active, tap [Analysis], [Sketch], and then [Text].
 - This displays a dialog box for inputting text.
- (2) Enter the text you want and then tap [OK].
 - This displays the word "Text" in the lower right corner of the Graph window.

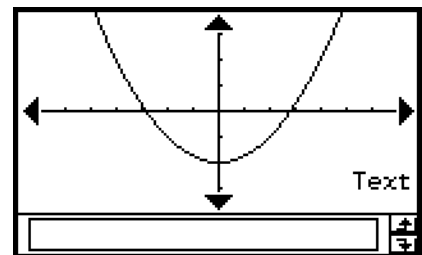

- (3) Place the stylus on the screen and hold it there.
 - This causes the text you input in step (2) to appear at the location where you are pointing with the stylus.

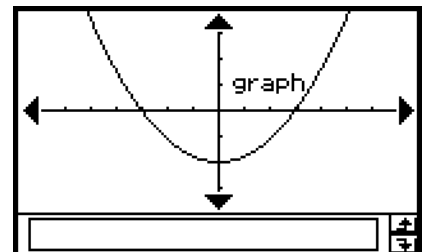

- (4) Drag the text to the location you want, and then lift the stylus from the screen.

Tip

- The amount of text you can input is limited only by how much can fit on the Graph window.
- You can repeat the above operation and input multiple text blocks, if you want.
- You cannot edit text after inputting it into a graph. To make any changes in text, you first need to clear the existing text (page 3-6-5) and then replace it with new text.

• **To draw a line tangent to a graph**

Example: To draw a line tangent to the graph $y = x^2 - x - 2$ when $x = 1$

- (1) In line y1 of the Graph Editor window, input and save $y = x^2 - x - 2$.
- (2) Tap  to graph the function.
- (3) Tap [Analysis], [Sketch], and then [Tangent].
 - This displays the crosshair pointer along with its corresponding coordinate values.

- (4) Press .
 - This displays a dialog box for inputting the point of tangency x -value, with 1 specified as the point.

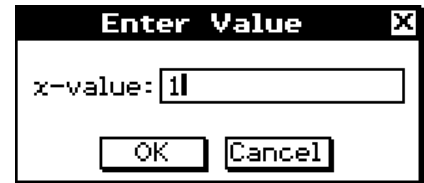

- (5) Tap [OK].
 - This closes the dialog box and moves pointer to the location you specified in step (4).
- (6) Press .

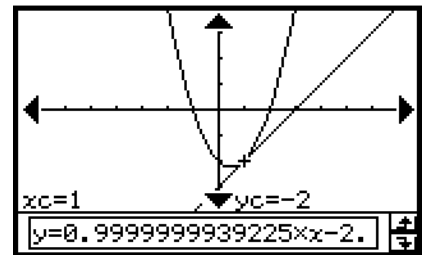

Tip

- Instead of inputting coordinate values in steps (4) and (5), you can use the cursor key or the graph controller arrows to move the pointer to the point of tangency on the Graph window.

• **To draw a line that is normal to a graph**

The procedure for drawing a line that is normal to a graph is virtually identical to the procedure “To draw a line tangent to a graph”, above. The only difference is in step (3), where you need to tap [Analysis], [Sketch], and then [Normal] instead of [Tangent].

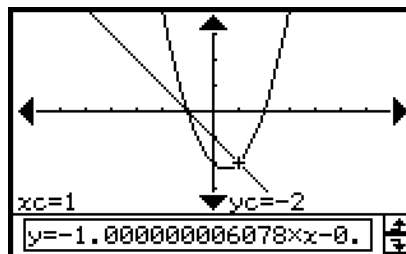

• To graph the inverse of a function

Example: To graph $y = x^2 - x - 2$ and then overlay it with $x = y^2 - y - 2$

- (1) In line y1 of the Graph Editor window, input and save $y = x^2 - x - 2$.
- (2) Tap  to graph the function.
- (3) Tap [Analysis], [Sketch], and then [Inverse].
 - This graphs the inverse function. The message box briefly shows the inverse function.

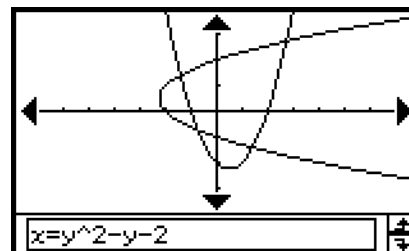

Tip

- If a function does not have an inverse, the graph produced by the [Inverse] command will be the result of interchanging the x and y variables of the original function.

• To draw a circle

Example: To draw a circle with a center point located at (1, 1) and a radius of 2

- (1) While the Graph window is active, tap [Analysis], [Sketch], and then [Circle].
 - This display “Circle” on the Graph window.
- (2) Press .
 - This displays a dialog box for specifying the center point coordinates (x, y) and the radius r , with 1 specified as the value of x .

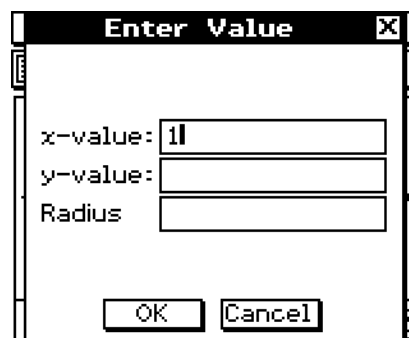

- (3) Enter value for x , y , and r , and then tap [OK].
 - This closes the dialog box and draws the circle according to your specifications. The message box shows the function for the circle.

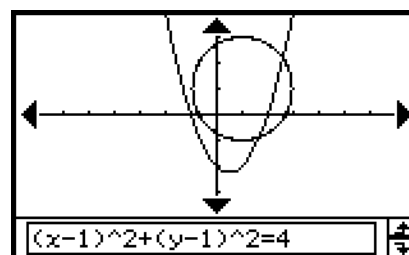

Tip

- Instead of inputting values, you can also draw a circle using stylus operations only. To do so, perform the following operation in place of step (2) of the above operation.
 - (2) Tap the point where you want the center of the circle to be, and then tap a second point anywhere on the circle’s circumference.
- You could also tap the center point, and then drag to the second point.

- **To draw a vertical or horizontal line**

Example: To draw a vertical line at $x = 2$

- (1) While the Graph window is active, tap [Analysis], [Sketch], and then [Vertical].
 - This displays “Vertical” on the Graph window, and the ClassPad waits for you to draw the vertical line.
- (2) Press **2**.
 - This displays a dialog box for specifying the x -coordinate of the vertical line, with 2 specified as the x -coordinate.
 - Instead of inputting a value here, you can use the stylus to tap the point through which the vertical line should pass.
- (3) Tap [OK].
 - This closes the dialog box and draws the vertical line at $x = 2$.

Tip

- To draw a horizontal line, tap [Analysis], [Sketch], and then [Horizontal] in place of [Vertical] in step (1) of the above procedure. In the case of a horizontal line, you need to specify the y -coordinate in step (2).

- **To clear figures inserted using the Sketch menu**

To clear plots, lines, text, or other figures inserted using the [Sketch] menu, tap [Analysis], [Sketch], and then [Cls].

- This redraws the graph to what is stored on the Graph Editor window.



3-7 Using Trace

Trace lets you move a point along a graph and displays the coordinates for the current pointer location. You can also link the trace operation to the number table used to draw a graph, so the pointer jumps to the coordinates that are currently selected in the table.



Using Trace to Read Graph Coordinates

Starting the trace operation causes a crosshair pointer to appear on the graph. You can then press the cursor key or tap the graph controller arrows to move the pointer. The coordinates are displayed as you move the pointer.

• To perform a trace operation

Example: To graph the function $y = x^2 - 3$ and then use the trace operation to read coordinates on the graph

- (1) Tap to display the View Window dialog box, and then configure it with the following parameters.

$$\begin{aligned} x_{\min} &= -5, & x_{\max} &= 5, & x_{\text{scale}} &= 1 \\ y_{\min} &= -10, & y_{\max} &= 10, & y_{\text{scale}} &= 2 \end{aligned}$$

- (2) On the Graph Editor window, input and store $x^2 - 3$ into line y1, and then tap to graph it.

- (3) Tap [Analysis], [Trace], or tap .

- The pointer will not be visible when it is located at a point outside the graph display area.
- If “Error” appears in place of the x_c or y_c coordinate, it means that the current point is undefined. Press the left or right cursor key to move to a point that is defined.

- (4) Press the left or right cursor key, or tap the left or right graph controller arrow.

- This moves the pointer along the graph, and displays the coordinates of the current pointer location.

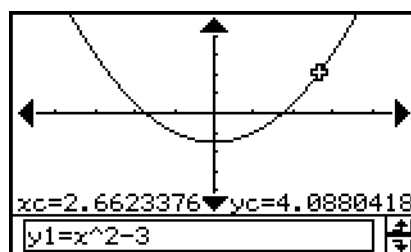

- You can also move the pointer to a particular point by inputting coordinates. Pressing a number key displays a dialog box for inputting coordinates. Input the values you want and then tap [OK].
- When there are multiple graphs on the Graph window, you can use the up and down cursor keys or the up and down graph controller arrows to move the pointer between graphs.

(5) To quit the trace operation, tap **ESC** on the icon panel.

Tip

- While the trace pointer is on the window, tapping the displayed coordinate values causes the coordinate values to appear in the message box. You can then copy the coordinates to the clipboard.

■ Specifying the Format of the Coordinates Displayed by Trace

Check boxes on the Graph Format dialog box (page 1-9-6) let you specify whether you want to display pointer coordinates only, or pointer coordinates plus the derivative. You can also turn off the display of the coordinates, if you want.

To do this:	Do this:
Display coordinates and the derivative	Select the [Derivative/Slope] check box under [Graph Format].
Turn off coordinate display	Clear the [Coordinate] check box under [Graph Format]. • Neither coordinates nor the derivative is displayed when the [Coordinate] check box is cleared, regardless of the current [Derivative/Slope] setting.

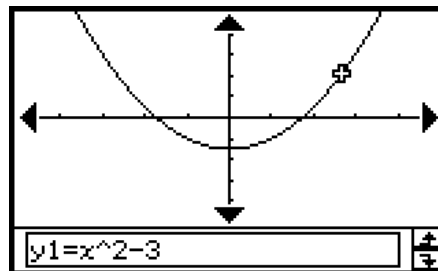
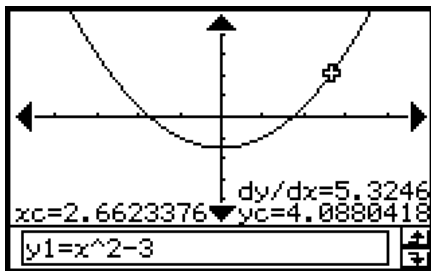

For details about Graph Format settings, see “Application Format Settings” on page 1-9-4.

Linking Trace to a Number Table

This section explains how you can link the movement of the trace pointer to the values in the number table used to draw the graph. This type of operation is called “linked trace”.

- For information about generating a number table and performing other table operations, see “3-4 Using Table & Graph”.

Example: To link trace to a number table created by graphing $y = 3\log x$

• ClassPad Operation

- (1) Display the View Window dialog box, and then configure it with the following parameters.

$x_{\min} = -5$, $x_{\max} = 5$, $x_{\text{scale}} = 1$
 $y_{\min} = -10$, $y_{\max} = 10$, $y_{\text{scale}} = 2$

- (2) Display the Table Input dialog box, and then configure it with the following settings.

Start: 2, End: 9, Step: 1

- (3) On the Graph Editor window, input and store $y = 3\log x$ into line y_1 , and then tap .

- This generates a number table and displays it.

- (4) Tap  and then [Link].

- This displays the Graph window and draws the graph, with the trace pointer located on the graph line. The coordinates of the trace pointer location will also be shown.
- Tapping a cell in the y_1 column causes the trace pointer to move the location of the cell's value.

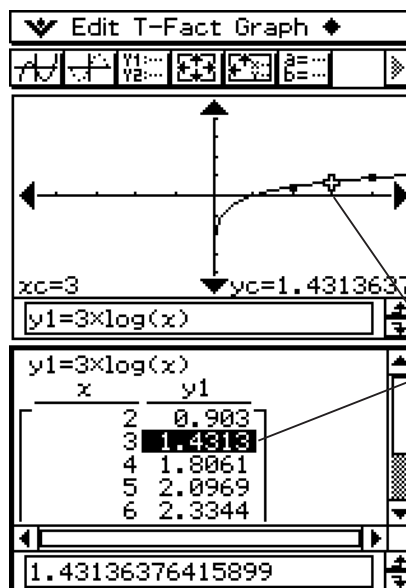

The highlighted table value corresponds to the current location of the trace pointer on the graph.

- (5) You can perform the following operations while a linked trace operation is in progress.

- You can move the highlighting in the number table by pressing the up and down cursor keys, or by tapping the cell you want to select. Doing so causes the trace pointer to jump to the corresponding location on the graph.

- (6) To quit the linked trace operation, tap **ESC** on the icon panel.



Generating Number Table Values from a Graph

A “graph-to-table” feature lets you extract the coordinate values at the current pointer location and input them into a table.

Example: Generate a table and graph for the expression $y = x^3 - 3x$, and input the coordinates for specific points on the graph into a table
Use the initial View Window settings (page 3-2-3).
Configure the Table Input settings shown below.

Start: 1, End: 4, Step: 1

• ClassPad Operation

- (1) Input the function $y = x^3 - 3x$ on the Graph Editor window.
- (2) Tap  to graph the function.
- (3) Tap  to generate the table.

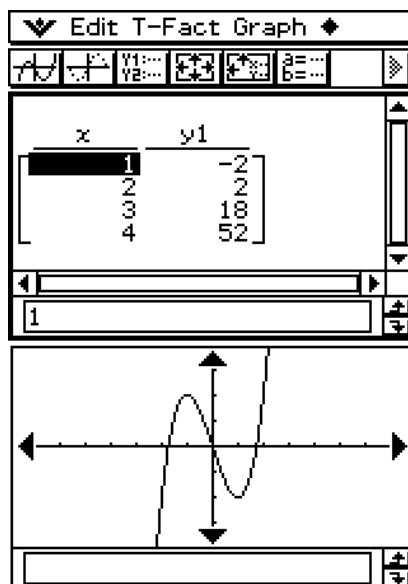

3-7-5
Using Trace

- (4) Tap the Graph window to make it active. Next, tap [Analysis] and then [Trace].
- This causes a pointer to appear on the graph.

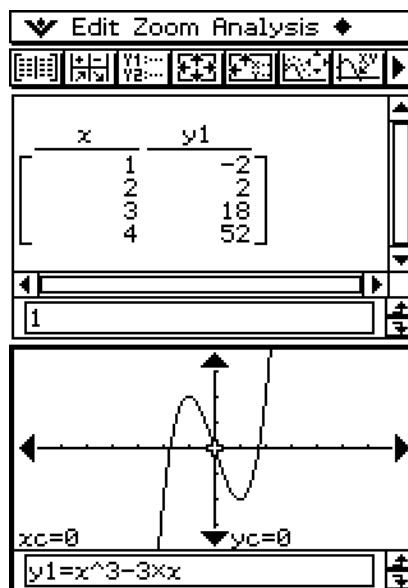

- (5) Use the cursor key to move the pointer along the graph until it reaches a point whose coordinates you want to input into the table.
- (6) Press EXE to input the coordinates at the current cursor position at the end of the table.

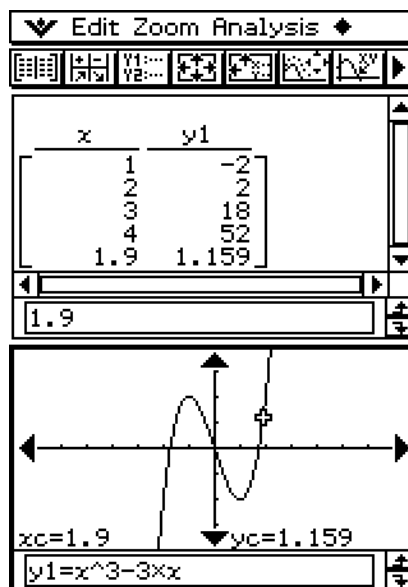

- (7) Repeat steps (5) and (6) to input the rest of the coordinates you want.

3-8 Analyzing a Function Used to Draw a Graph

Your ClassPad includes a G-Solve feature that lets you perform a variety of different analytical processes on an existing graph.

G-Solve Menu Overview

To access the [G-Solve] menu, tap [Analysis] and then [G-Solve]. The following describes the commands that are available on the [G-Solve] menu.

To obtain this for the graph:	Select this G-Solve menu command:
Root (the x -intercept)	Root
Maximum value	Max
Minimum value	Min
Maximum value in the range displayed on the Graph window	f Max
Minimum value in the range displayed on the Graph window	f Min
y -intercept	y -Intercept
Point of intersection for two graphs	Intersect
y -coordinate for a given x -coordinate	y -Cal
x -coordinate for a given y -coordinate	x -Cal
Definite integral for a particular range	$\int dx$
Point of inflection	Inflection
Distance between two points	Distance
Volume of a solid of revolution	$\pi \int (f(x))^2 dx$

Tip



- See page α -9-1 of the Appendix for information about graph types and executable G-Solve functions.

Using G-Solve Menu Commands

This section describes how to use each of the commands on the [G-Solve] menu. Note that all of the procedures in this section are performed in the Graph & Table application, which you can enter by tapping the  icon on the application menu.

• To obtain the root of a function

Example: To graph the function $y = x(x + 2)(x - 2)$ and obtain its root

- (1) Display the View Window dialog box, and then configure it with the following parameters.
 - $x_{\min} = -7.7$, $x_{\max} = 7.7$, $x_{\text{scale}} = 1$
 - $y_{\min} = -3.8$, $y_{\max} = 3.8$, $y_{\text{scale}} = 1$
- (2) On the Graph Editor window, input and store $y = x(x + 2)(x - 2)$ into line y1, and then tap  to graph it.
 - Make sure that only y1 is checked.
- (3) Tap [Analysis], [G-Solve], and then [Root], or tap .
 - This displays “Root” on the Graph window, and locates a pointer at the first solution of the root (root for smallest value of x). The x - and y -coordinates at the current pointer location are also shown on the Graph window.
- (4) To obtain other roots, press the left or right cursor key, or tap the left or right graph controller arrows.
 - If there is only one solution, the pointer does not move when you press the cursor key.

Result Screenshots

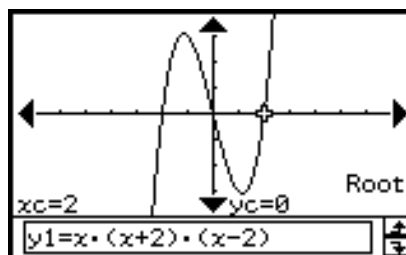
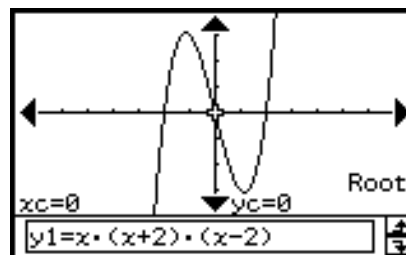
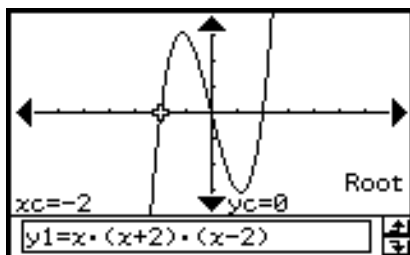

- To obtain the minimum value, maximum value, $f\text{Max}$, $f\text{Min}$, y -intercept, and inflection of a function

Example: To graph the function $y = \frac{1}{2}x^2(x+2)(x-2)$ and obtain its minimum value

- (1) Display the View Window dialog box, and then configure it with the following parameters.

$$\begin{aligned}x_{\min} &= -7.7, & x_{\max} &= 7.7, & x_{\text{scale}} &= 1 \\ y_{\min} &= -3.8, & y_{\max} &= 3.8, & y_{\text{scale}} &= 1\end{aligned}$$

- (2) On the Graph Editor window, input and store $y = \frac{1}{2}x^2(x+2)(x-2)$ into line y_1 , and then tap  to graph it.

- Make sure that only y_1 is checked.

- (3) Tap [Analysis], [G-Solve], and then [Min], or tap .

- This displays “Min” on the Graph window, and locates a pointer at the first solution of the minimum value (minimum value of y for smallest value of x). The x - and y -coordinates at the current pointer location are also shown on the Graph window.

- (4) To obtain other minimum values, press the left or right cursor key, or tap the left or right graph controller arrows.

- If there is only one solution, the pointer does not move when you press the cursor key.

Result Screenshots

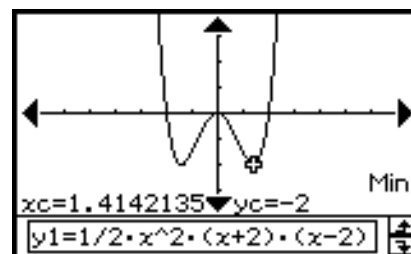
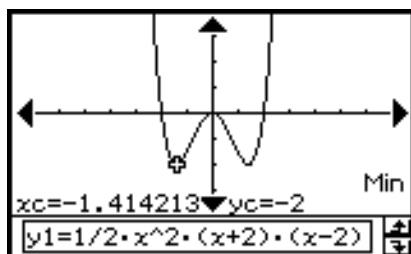

Tip

- To obtain the other values, select the applicable command on the [G-Solve] menu in step (3) of the above procedure.

To obtain this value:	Select this G-Solve menu command:
Maximum value	Max (or tap )
Maximum value in the range displayed on the Graph window	$f\text{Max}$
Minimum value in the range displayed on the Graph window	$f\text{Min}$
y -intercept	y -intercept
Point of inflection	Inflection

• **To obtain the point of intersection for two graphs**

Example: To graph the functions $y = x + 1$ and $y = x^2$, and determine their point of intersection

- (1) Display the View Window dialog box, and then configure it with the following parameters.

$$\begin{aligned} x_{\min} &= -5, & x_{\max} &= 5, & x_{\text{scale}} &= 1 \\ y_{\min} &= -5, & y_{\max} &= 5, & y_{\text{scale}} &= 2 \end{aligned}$$

- (2) On the Graph Editor window, input and store $y = x + 1$ into line y_1 and $y = x^2$ into y_2 , and then tap  to graph them.

- Make sure that only y_1 and y_2 are checked.

- (3) Tap [Analysis], [G-Solve], and then [Intersect].

- This causes “Intersect” to appear on the Graph window, with a pointer located at the point of intersection. The x - and y -coordinates at the current pointer location are also shown on the Graph window.

- (4) To obtain other points of intersection, press the left or right cursor key, or tap the left or right graph controller arrows.

Result Screenshots

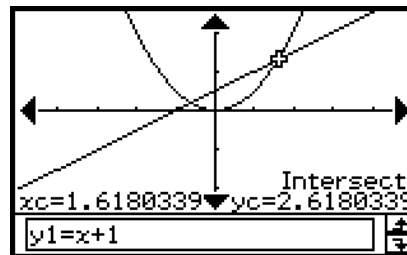
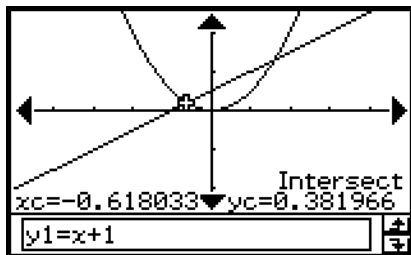

• **To determine coordinates at a particular point on a graph**

Example: To graph the function $y = x(x + 2)(x - 2)$ and determine the y -coordinate when $x = 0.5$, and the x -coordinate when $y = 2.2$

- (1) Display the View Window dialog box, and then configure it with the following parameters.
 - $x_{\min} = -7.7$, $x_{\max} = 7.7$, $x_{\text{scale}} = 1$
 - $y_{\min} = -3.8$, $y_{\max} = 3.8$, $y_{\text{scale}} = 1$
- (2) On the Graph Editor window, input and store $y = x(x + 2)(x - 2)$ into line y_1 , and then tap $\left[\frac{\uparrow}{\downarrow} \right]$ to graph it.
 - Make sure that only y_1 is checked.
- (3) To obtain the value of y for a particular x -value, tap [Analysis], [G-Solve], and then [y-Cal].
 - This displays a dialog box for specifying the x -value.
- (4) For this example, input 0.5 and then tap [OK].
 - This moves the pointer to the location on the graph where $x = 0.5$, and displays the x -coordinate and y -coordinate at that location.
- (5) To obtain the value of x for a particular y -value, tap [Analysis], [G-Solve], and then [x-Cal].
 - This displays a dialog box for specifying the y -value.
- (6) For this example, input 2.2 and then tap [OK].
 - This moves the pointer to the location on the graph where $y = 2.2$, and displays the x -coordinate and y -coordinate at that location.

Result Screenshots

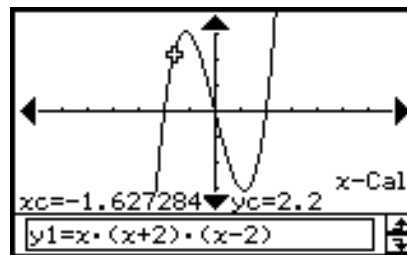
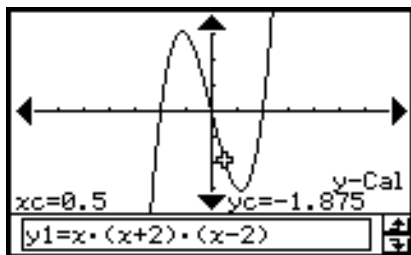

Tip

- When there are multiple results for the above procedure, press \blacktriangleright to calculate the next value. Pressing \blacktriangleleft returns to the previous value.

• **To determine the definite integral for a particular domain**

Example: To graph the function $y = x(x + 2)(x - 2)$ and obtain its definite integral in the domain of $1 \leq x \leq 2$

- (1) Display the View Window dialog box, and then configure it with the following parameters.

$$\begin{aligned} x_{\min} &= -7.7, & x_{\max} &= 7.7, & x_{\text{scale}} &= 1 \\ y_{\min} &= -4, & y_{\max} &= 4, & y_{\text{scale}} &= 1 \end{aligned}$$

- (2) On the Graph Editor window, input and store $y = x(x + 2)(x - 2)$ into line y1, and then tap $\boxed{\text{Graph}}$ to graph it.

- Make sure that only y1 is checked.

- (3) Tap [Analysis], [G-Solve], and then $\boxed{\int dx}$.

- This displays “Lower” on the Graph window.

- (4) Press $\boxed{1}$.

- This displays a dialog box for inputting an interval for the x -values, with 1 specified for the lower limit of the x -axis (Lower).

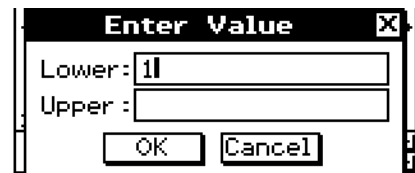

- (5) Tap the [Upper] input box and then input 2 for the upper limit of the x -axis.

- (6) Tap [OK].

Tip

- Instead of inputting [Lower] and [Upper] values in steps (4) through (6), you can use the cursor key or the graph controller arrows to move the pointer along the graph to specify the lower limit and upper limit. If you do, perform the following two steps after step (3).

- (4) Use the cursor key or the graph controller to move the pointer to the location of the lower limit and then press $\boxed{\text{EXE}}$.

- This registers the lower limit and changes the word in the lower right corner of the Graph window to “Upper”.

- (5) Move the pointer to the location of the upper limit, and then press $\boxed{\text{EXE}}$.

Result Screenshot

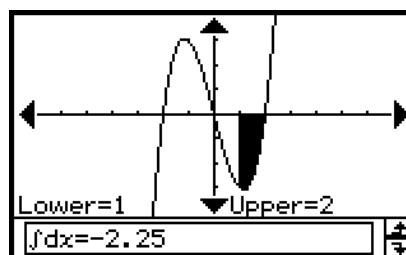

- **To determine the distance between any two points**

- (1) Tap the Graph window to make it active.
- (2) Tap [Analysis], [G-Solve], and then [Distance].
 - This displays “Distance” on the Graph window, and the ClassPad waits for you to specify the first point.
- (3) Tap the first point on the Graph window.
 - This causes a pointer to appear at the location where you tap.
- (4) Tap the second point on the Graph window.
 - This causes a pointer to appear at the second point, and the distance between the two points to appear in the message box.

- **Result Screenshot**

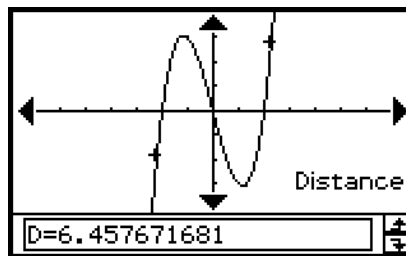

- **Tip**

- Instead of tapping points on the Graph window, you could also specify points by inputting their coordinates. Without tapping the Graph window, input a value. This causes a coordinate specification dialog box to appear. Input the x - and y -coordinates of the two points.

- **To determine the inflection point**

You can use the following procedure to determine coordinates of the inflection point for a cubic function.

Example: To graph the function $y = x^3 - 1$ and determine its inflection point

- **ClassPad Operation**

- (1) Display the View Window dialog box, and then configure it with the following parameters.

$x_{\min} = -4.9,$	$x_{\max} = 4.9,$	$x_{\text{scale}} = 1$
$y_{\min} = -3.3,$	$y_{\max} = 1.8,$	$y_{\text{scale}} = 1$

- (2) On the Graph Editor window, input and store $y1 = x^3 - 1$ into line $y1$, and then tap  to graph it.
- Make sure that only “ $y1$ ” is selected (checked).
- (3) Tap [Analysis], [G-Solve], and then [Inflection].
- This causes “Inflection” to appear on the Graph window, with a pointer located at the point of inflection.

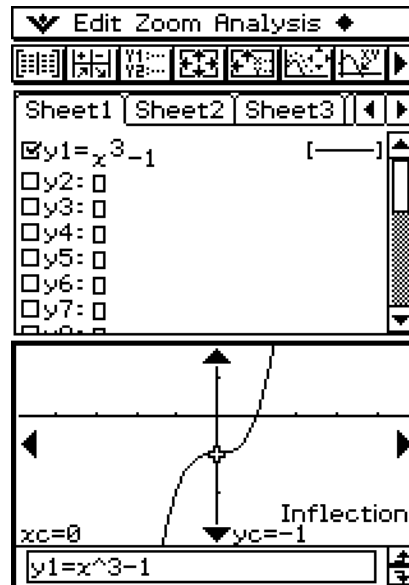

Tip

- If your function has multiple inflection points, use the cursor button or graph controller arrows to move the pointer between them and display their coordinates.

• To obtain the volume of a solid of revolution

Example: To graph the function $y = x^2 - x - 2$ and obtain the volume of a solid of revolution as the line segment from $x = 1$ to $x = 2$ is rotated on the x -axis

- (1) Display the View Window dialog box, and then configure it with the following parameters.
- $x_{\min} = -7.7$, $x_{\max} = 7.7$, $x_{\text{scale}} = 1$
 $y_{\min} = -3.8$, $y_{\max} = 3.8$, $y_{\text{scale}} = 1$
- (2) On the Graph Editor window, input and store $y = x^2 - x - 2$ into line $y1$, and then tap  to graph it.
- Make sure that only $y1$ is checked.
- (3) Tap [Analysis], [G-Solve], and then $[\pi \int (f(x))^2 dx]$.
- This displays a crosshair pointer on the graph, and the word “Lower” in the lower right corner of the Graph window.

(4) Press $\boxed{1}$.

- This displays a dialog box for inputting an interval of values for x , with 1 specified for the lower limit of the x -axis (Lower).

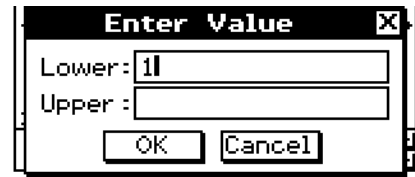

(5) Tap the [Upper] input box and then input 2 for the upper limit of the x -axis.

(6) Tap [OK].

- This causes a silhouette of the solid of revolution to appear on the Graph window, and its volume to appear in the message box.

Tip

- Instead of inputting [Lower] and [Upper] values in steps (4) through (6), you can use the cursor key or the graph controller arrows to move the pointer along the graph to specify the lower limit and upper limit. If you do, perform the following two steps after step (3).
 - (4) Use the cursor key or the graph controller to move the pointer to the location of the lower limit and then press $\boxed{\text{EXE}}$.
 - This registers the lower limit and changes the word in the lower right corner of the Graph window to “Upper”.
 - (5) Move the pointer to the location of the upper limit, and then press $\boxed{\text{EXE}}$.

Result Screenshot

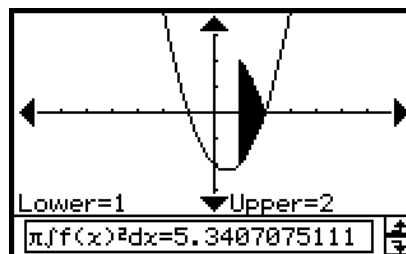

Chapter

4

4

Using the Conics Application

The Conics application provides you with the capability to graph circular, parabolic, elliptic, and hyperbolic functions. You can also use the Conics application to quickly and easily determine the proper focal point, vertex, directrix, axis of symmetry, latus rectum, center, radius, asymptote, eccentricity, and even the x - and y -intercepts of each type of conics.

- 4-1 Conics Application Overview**
- 4-2 Inputting Equations**
- 4-3 Drawing a Conics Graph**
- 4-4 Using Trace to Read Graph Coordinates**
- 4-5 Using G-Solve to Analyze a Conics Graph**

4-1 Conics Application Overview

This section describes the configuration of the Conics application windows, and provides basic information about its menus and commands.

- The Conics application uses many of the same commands (Zoom, Trace, Sketch, etc.) as the Graph & Table application. It is recommended that you familiarize yourself with Graph & Table operations before trying to use the Conics application.

Starting Up the Conics Application

Use the following procedure to start up the Conics application.

- **ClassPad Operation**

On the application menu, tap .

This starts the Conics application and displays the Conics Editor window and the Conics Graph window.

Conics Application Window

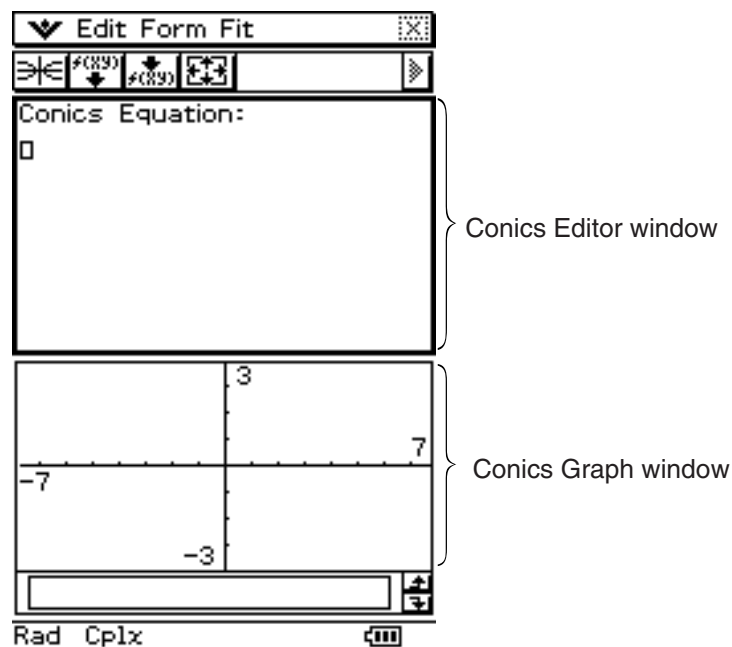

When you start up the Conics application, two windows appear on the display: the Conics Editor window and the Conics Graph window. A function that is input on the Conics Editor window is graphed on the Conics Graph window.



- The Conics Editor window can have one conics equation input at a time. The Conics application includes a number of preset conics formats (page 4-2-1) that make equation input quick and easy.
- You can tap the graph controller arrows (page 3-2-6) or use the cursor key to scroll the Conics Graph window.
- You can use Trace (page 4-4-1) to trace a conics graph.







Conics Application Menus and Buttons

This section explains the operations you can perform using the menus and buttons of the Conics application window.

- For information about the  menu, see “Using the  Menu” on page 1-5-4.



■ Conics Editor Window Menus and Buttons

The following describes the menu and button operations you can perform while the Conics Editor window is active.





To do this:	Tap this button:	Or select this menu item:
Cut the selected character string and place it onto the clipboard	—	Edit - Cut
Copy the selected character string to the clipboard	—	Edit - Copy
Paste the contents of the clipboard at the current cursor position in the Conics Editor window	—	Edit - Paste
Select all of the text on the Conics Editor window	—	Edit - Select All
Clear all of the text from the Conics Editor window	—	Edit - Clear All
Draw a graph		—
Insert a Conics Form on the Conics Editor window		Form - Insert Conics Form
Adjust the equation on the Conics Editor window so it fits a Conics Form		Fit - Fit into Conics Form
Display the View Window dialog box (page 3-2-1) to configure Graph window settings		 - View Window
Display the Variable Manager (page 1-8-1)	—	 - Variable Manager

■ Conics Graph Window Menus and Buttons

The following describes the menu and button operations you can perform while the Conics Graph window is active.

To do this:	Tap this button:	Or select this menu item:
Enlarge the part of the screen bounded by a box		Zoom - Box
Specify a zoom factor	—	Zoom - Factor
Zoom in by the zoom factor	—	Zoom - Zoom In
Zoom out by the zoom factor	—	Zoom - Zoom Out
Configure View Window y -axis parameters and redraw the graph so it fills the Graph window along the y -axis		Zoom - Auto
Return a graph to its original size	—	Zoom - Original
Adjust View Window x -axis values so they are identical to the y -axis values	—	Zoom - Square
Round coordinate values displayed using Trace (page 4-4-1)	—	Zoom - Round
Make the value of each dot equal 1, which makes all coordinate values integers	—	Zoom - Integer
Return View Window parameters to their settings prior to the last zoom operation	—	Zoom - Previous
Perform a quick zoom operation (page 3-2-9)	—	Zoom - Quick Initialize
	—	Zoom - Quick Trig
	—	Zoom - Quick $\log(x)$
	—	Zoom - Quick e^x
	—	Zoom - Quick x^2
	—	Zoom - Quick $-x^2$
	—	Zoom - Quick Standard
Display the coordinates at a particular point on a graph		Analysis - Trace
Insert a point, graphic, or text into an existing graph • For details about this operation, see “3-6 Using the Sketch Menu”.	—	Analysis - Sketch
Perform a G-Solve operation • For details about this operation, see “4-5 Using G-Solve to Analyze a Conics Graph”.	—	Analysis - G-Solve



To do this:	Tap this button:	Or select this menu item:
Save a graph as image data (page 3-2-10)	—	◆ - Store Picture
Recall the image of a graph (page 3-2-10)	—	◆ - Recall Picture
Re-draw a graph		◆ - ReDraw
Make the Conics Editor window active		▼ - Conics Editor
Display the View Window dialog box (page 3-2-1) to configure Graph window settings		▼ - View Window
Activate the pan function for dragging the Graph window with the stylus		—
Display the Variable Manager (page 1-8-1)	—	▼ - Variable Manager

Tip

- The [Tangent], [Normal], and [Inverse] commands of the Graph & Table application's Sketch function are not included in the Conics application.
- The G-Solve feature of the Conics application performs analysis that is specially suited to conics, and so it operates differently from the G-Solve feature of the Graph & Table application.

Conics Application Status Bar

The status bar at the bottom of the Conics application shows the current angle unit setting and [Complex Format] setting (page 1-9-5).

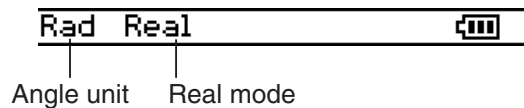

If you see this:	It means this:
Rad	The angle unit setting is radians.
Deg	The angle unit setting is degrees.
Gra	The angle unit setting is grads.
Cplx	The Complex (complex number calculation) mode is selected.
Real	The Real (real number calculation) mode is selected.

Tip











- Press and drag stylus to view coordinates in status bar.

4-2 Inputting Equations

This section explains the various ways you can input equations using the Conics Editor window.



Using a Conics Form to Input an Equation

Preset formats can help you input conics equations quickly and easily. The following table contains a complete list of the types of equations that you can input just by tapping [Form] and then [Insert Conics Form].

Conics Forms	Equations
$\bigcirc X=A(Y-K)^2+H$ 	Horizontal Parabola 1 $x = A \cdot (y - K)^2 + H$
$\bigcirc X=AY^2+BY+C$ 	Horizontal Parabola 2 $x = A \cdot y^2 + B \cdot y + C$
$\bigcirc Y=A(X-H)^2+K$ 	Vertical Parabola 1 $y = A \cdot (x - H)^2 + K$
$\bigcirc Y=AX^2+BX+C$ 	Vertical Parabola 2 $y = A \cdot x^2 + B \cdot x + C$
$\bigcirc (X-H)^2+(Y-K)^2=R^2$ 	Circle 1 $(x - H)^2 + (y - K)^2 = R^2$
$\bigcirc AX^2+AY^2+BX+CY+D=0$ 	Circle 2 $A \cdot x^2 + A \cdot y^2 + B \cdot x + C \cdot y + D = 0$
$\bigcirc \frac{(X-H)^2}{A^2} + \frac{(Y-K)^2}{B^2} = 1$ 	Ellipse $(x - H)^2 \div A^2 + (y - K)^2 \div B^2 = 1$
$\bigcirc \frac{(X-H)^2}{A^2} - \frac{(Y-K)^2}{B^2} = 1$ 	Horizontal Hyperbola $(x - H)^2 \div A^2 - (y - K)^2 \div B^2 = 1$
$\bigcirc \frac{(Y-K)^2}{A^2} - \frac{(X-H)^2}{B^2} = 1$ 	Vertical Hyperbola $(y - K)^2 \div A^2 - (x - H)^2 \div B^2 = 1$
$\bigcirc AX^2+BX^2+CY^2+DX+EY+F=0$ 	General Form $A \cdot x^2 + B \cdot x \cdot y + C \cdot y^2 + D \cdot x + E \cdot y + F = 0$

• To input an equation using a Conics Form

Example: To use a Conics Form to input the equation for a parabola with a horizontal axis (principal axis parallel with x -axis)

- (1) On the application menu, tap  to start the Conics application.
- (2) On the Conics Editor window, tap , or tap [Form] and then [Insert Conics Form].
 - This displays the Select Conics Form dialog box.

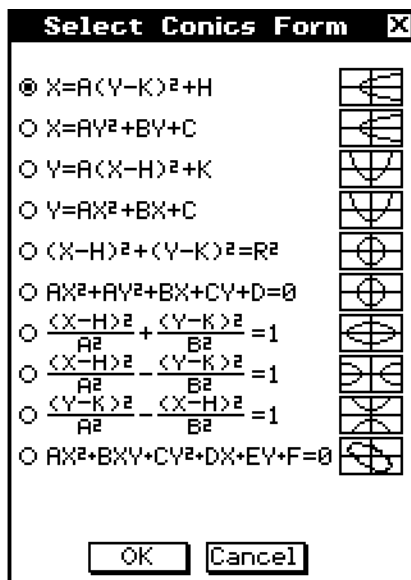

- (3) Select the Conics Form of the type of equation you want to graph, and then tap [OK].
 - Since we want to graph a parabola with a horizontal axis in this example, select “ $X = A(Y - K)^2 + H$ ”. Tap [OK] to close the Select Conics Form dialog box, and display the selected equation in the Conics Editor window.

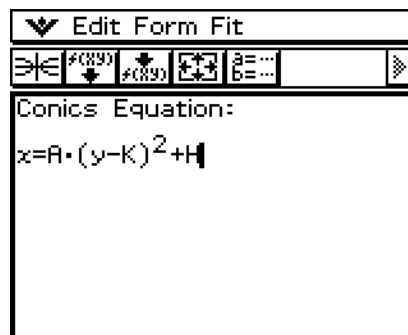

- (4) Modify the equation on the Conics Editor window as required.
 - Here, we will change the coefficients of the equation as follows: $A = 2$, $K = 1$, $H = -2$.

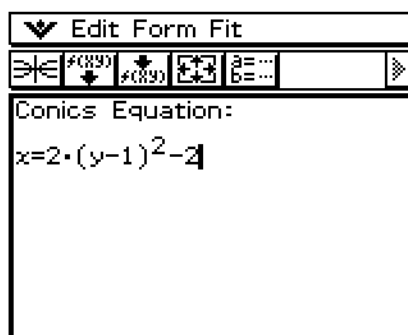

- (5) Tap  to graph the equation.

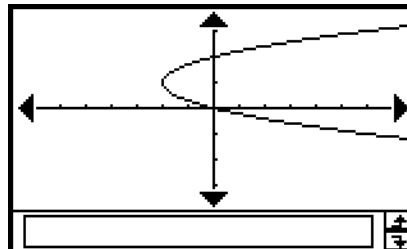

Inputting an Equation Manually

To input an equation manually, make the Conics Editor window active, and then use the soft keyboard for input.

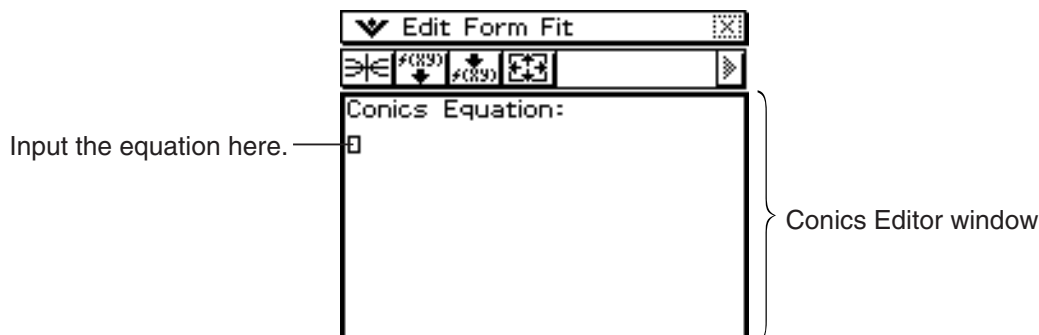

Transforming a Manually Input Equation to a Conics Form

After you manually input an equation on the Conics Editor window, you can use the procedure below to transform it to a preset Conics Form.

Example: To transform the equation $\frac{(x-1)^2}{2^2} + (y-2)^2 = \frac{x^2}{4}$ to the standard Conics Form $x = Ay^2 + By + C$

• ClassPad Operation

- (1) On the Conics Editor window, input the above equation.

Hint: Tap the **2D** tab of the soft keyboard. The 2D fraction and 2D exponent are very helpful in entering this equation!

- (2) After inputting the equation, tap **[Fit]** or tap [Fit] and then [Fit into Conics Form].

- This displays the Select Conics Form dialog box.

- (3) Select “X = AY² + BY + C” and then tap [OK].

- This transforms the equation so it becomes $x = 2y^2 - 8y + \frac{17}{2}$.

Tip

- If the equation you input cannot be transformed into the standard Conics Form you selected, the message “Can’t Transform into This Type” appears.
- An input equation may not transform correctly if it includes a square root calculation or some other function.

4-3 Drawing a Conics Graph

This section provides examples that show how to draw various types of conics graphs.

Drawing a Parabola

A parabola can be drawn with either a horizontal or vertical orientation. The parabola type is determined by the direction of its principal axis.



■ Drawing a Parabola that Opens Horizontally

A parabola with a horizontal axis is one whose principal axis is parallel to the x -axis. There are two possible equations for a parabola with a horizontal axis:

$$x = A(y - K)^2 + H \text{ and } x = Ay^2 + By + C.$$

Example 1: To draw the parabola $x = 2(y - 1)^2 - 2$

● ClassPad Operation

- (1) On the Conics Editor window, tap , or tap [Form] and then [Insert Conics Form].
 - This displays the Select Conics Form dialog box.
- (2) Select “ $X = A(Y - K)^2 + H$ ” and then tap [OK].
 - This closes the Select Conics Form dialog box, and displays the selected equation in the Conics Editor window.
- (3) Change the coefficients of the equation as follows: $A = 2$, $K = 1$, $H = -2$.
- (4) Tap  to graph the equation.

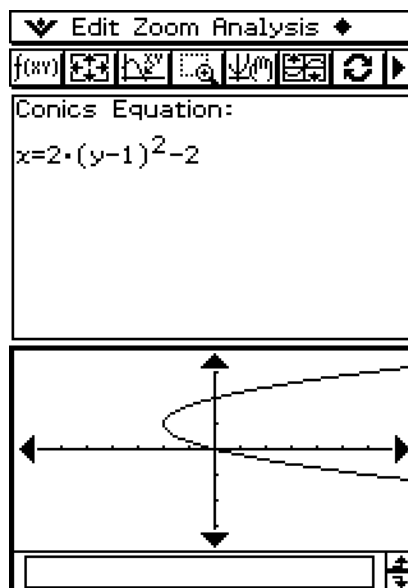

Example 2: To draw the parabola $x = y^2 + 2y + 3$

• **ClassPad Operation**

- (1) In step (2) of the above procedure, select “ $X = AY^2 + BY + C$ ” on the Select Conics Form dialog box.
- (2) In step (3) of the above procedure, change the coefficients of the equation as follows:
A = 1, B = 2, C = 3.

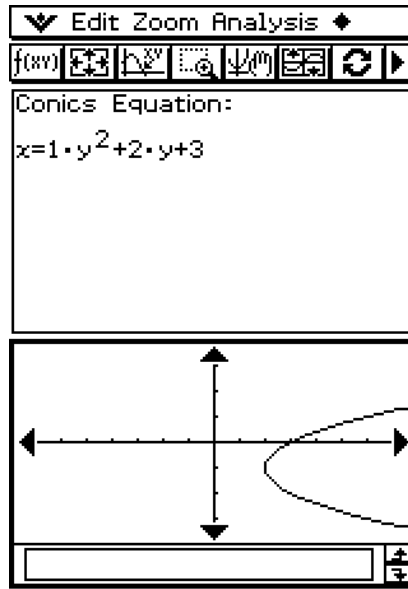

■ Drawing a Parabola that Opens Vertically

A parabola with a vertical axis is one whose principal axis is parallel to the y -axis. There are two possible equations for a parabola with a vertical axis:

$$y = A(x - H)^2 + K \text{ and } y = Ax^2 + Bx + C.$$

● ClassPad Operation

- (1) In step (2) of the procedure under “Drawing a Parabola that Opens Horizontally”, select “ $Y = A(X - H)^2 + K$ ” or “ $Y = AX^2 + BX + C$ ”.
- (2) Specify values for the coefficients.

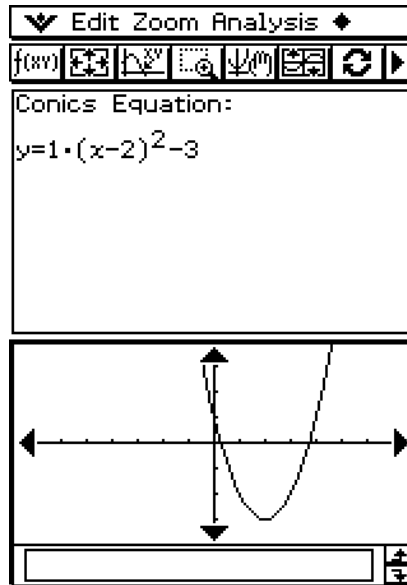



Drawing a Circle

There are two forms that you can use to draw a circle. One form is the standard form, which allows you to specify the center point and radius. The other form is the general form, which allows you to specify the coefficients of each term.

■ Drawing a Circle by Specifying a Center Point and Radius

Example: To draw a circle with a center point of (2, 1) and a radius of 2

● ClassPad Operation

- (1) On the Conics Editor window, tap , or tap [Form] and then [Insert Conics Form].
 - This displays the Select Conics Form dialog box.
- (2) Select “ $(X - H)^2 + (Y - K)^2 = R^2$ ” and then tap [OK].
 - This closes the Select Conics Form dialog box, and displays the selected equation in the Conics Editor window.
- (3) Change the coefficients of the equation as follows: $H = 2$, $K = 1$, $R = 2$.
- (4) Tap  to graph the equation.

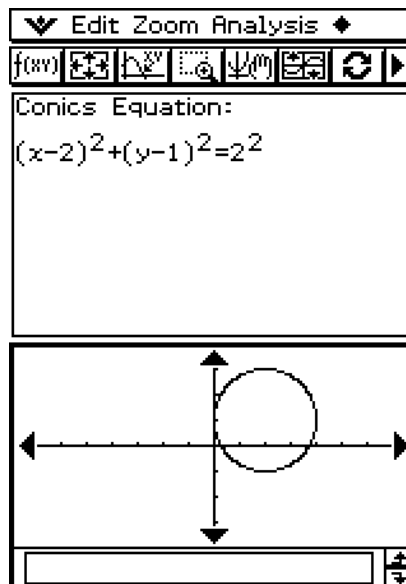

■ Drawing a Circle by Specifying the Coefficients of a General Equation

Example: To draw the circle $x^2 + y^2 + 4x - 6y + 9 = 0$

● ClassPad Operation

- (1) In step (2) of the procedure under “Drawing a Circle by Specifying a Center Point and Radius”, select “ $AX^2 + AY^2 + BX + CY + D = 0$ ”.
- (2) Substitute the following values for the coefficients: $A = 1$, $B = 4$, $C = -6$, $D = 9$.

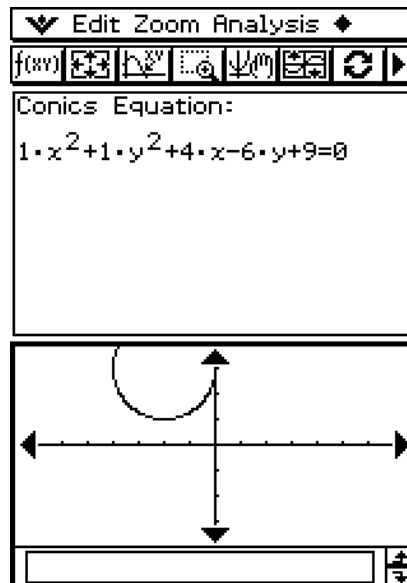



Drawing an Ellipse

You can draw an ellipse by specifying coefficients for the standard equation:

$$\frac{(x - H)^2}{A^2} + \frac{(y - K)^2}{B^2} = 1.$$

Example: To draw the ellipse $\frac{(x - 1)^2}{2^2} + \frac{(y - 2)^2}{3^2} = 1$

● ClassPad Operation

- (1) On the Conics Editor window, tap , or tap [Form] and then [Insert Conics Form].
 - This displays the Select Conics Form dialog box.
- (2) Select “ $\frac{(X - H)^2}{A^2} + \frac{(Y - K)^2}{B^2} = 1$ ” and then tap [OK].
 - This closes the Select Conics Form dialog box, and displays the selected equation in the Conics Editor window.
- (3) Change the coefficients of the equation as follows: $A = 2$, $B = 3$, $H = 1$, $K = 2$.
- (4) Tap  to graph the equation.

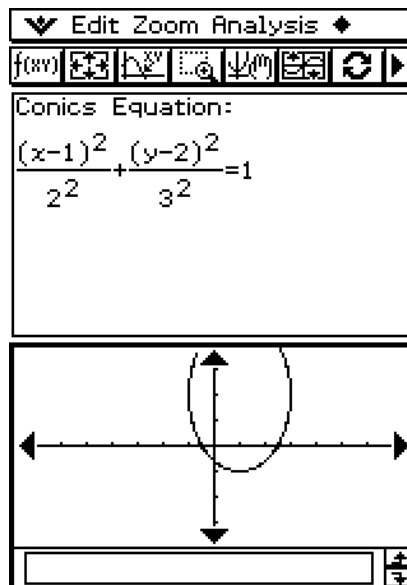

Drawing a Hyperbola



A hyperbola can be drawn with either a horizontal or vertical orientation. The hyperbola type is determined by the direction of its principal axis.

■ Drawing a Hyperbola that Opens Horizontally

The standard form of a hyperbola with a horizontal axis is: $\frac{(x-H)^2}{A^2} - \frac{(y-K)^2}{B^2} = 1$.

Example: To draw the hyperbola with a horizontal axis $\frac{(x-1)^2}{2^2} - \frac{(y-2)^2}{3^2} = 1$

● ClassPad Operation

- (1) On the Conics Editor window, tap , or tap [Form] and then [Insert Conics Form].
 - This displays the Select Conics Form dialog box.
- (2) Select " $\frac{(X-H)^2}{A^2} - \frac{(Y-K)^2}{B^2} = 1$ " and then tap [OK].
 - This closes the Select Conics Form dialog box, and displays the selected equation in the Conics Editor window.
- (3) Change the coefficients of the equation as follows: A = 2, B = 3, H = 1, K = 2.
- (4) Tap  to graph the equation.

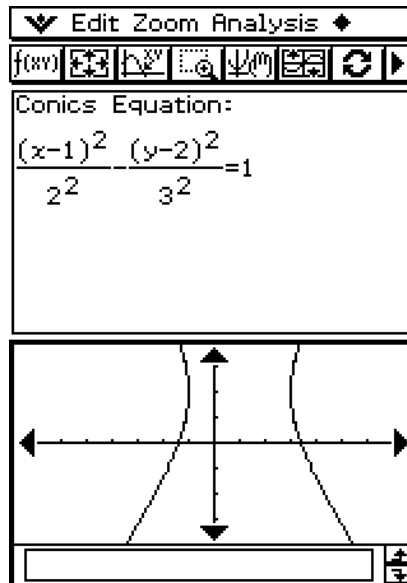

■ Drawing a Hyperbola that Opens Vertically

The standard form of a hyperbola with a vertical axis is: $\frac{(y-K)^2}{A^2} - \frac{(x-H)^2}{B^2} = 1$.

● ClassPad Operation

(1) In step (2) of the procedure under “Drawing a Hyperbola that Opens Horizontally”,

select “ $\frac{(Y-K)^2}{A^2} - \frac{(X-H)^2}{B^2} = 1$ ”.

(2) Specify values for the coefficients.

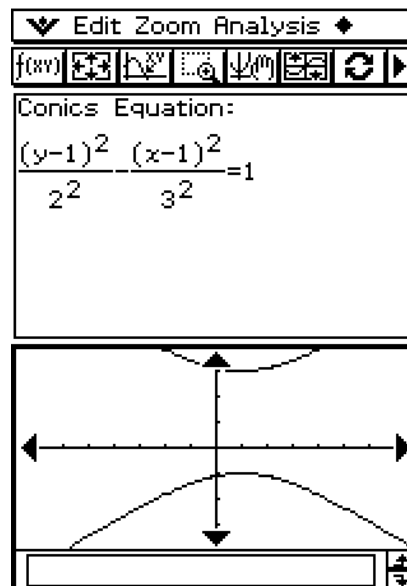



Drawing a General Conics

Using the conics general equation $Ax^2 + Bxy + Cy^2 + Dx + Ey + F = 0$, you can draw a parabola or hyperbola whose principal axis is not parallel either to the x -axis or the y -axis, a slanted ellipse, etc.

Example: To draw $x^2 + 4xy + y^2 - 6x + 6y + 4 = 0$

• ClassPad Operation

- (1) On the Conics Editor window, tap , or tap [Form] and then [Insert Conics Form].
 - This displays the Select Conics Form dialog box.
- (2) Select “ $AX^2 + BXY + CY^2 + DX + EY + F = 0$ ” and then tap [OK].
 - This closes the Select Conics Form dialog box, and displays the selected equation in the Conics Editor window.
- (3) Change the coefficients of the equation as follows: $A = 1$, $B = 4$, $C = 1$, $D = -6$, $E = 6$, $F = 4$.
- (4) Tap  to graph the equation.

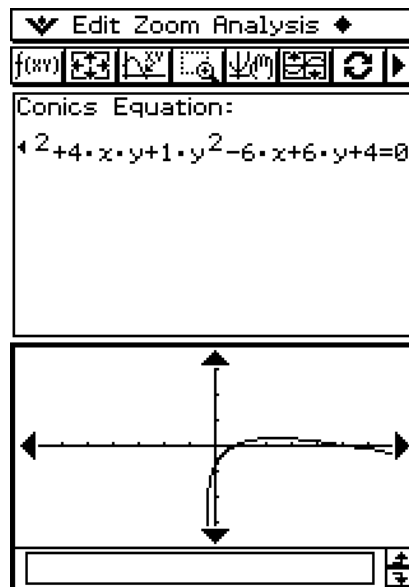

4-4 Using Trace to Read Graph Coordinates

Trace allows you move a pointer along a graph line and display the coordinates at the current pointer location.

Starting the trace operation causes a crosshair pointer (⊕) to appear on the graph. You can then press the cursor key or tap the graph controller arrows to move the pointer to the location you want, and read the coordinates that appear on the display.

Using Trace

Example: To graph the function $x = 2(y - 1)^2 - 2$ and then perform a trace operation to read coordinates

• ClassPad Operation

- (1) On the Conics Editor window, input the above equation and then tap $\boxed{\text{Graph}}$ to graph it.
- (2) Tap [Analysis] and then [Trace], or tap $\boxed{\text{Trace}}$.
 - This causes a pointer to appear on the graph line.
- (3) Press the left or right cursor key, or tap the left or right graph controller arrows.

- This moves the pointer along the graph, and displays the coordinates of the current pointer location.
- When the location of the pointer approaches the point of infinity on a parabolic or hyperbolic graph, "Error" appears in place of the pointer coordinates.

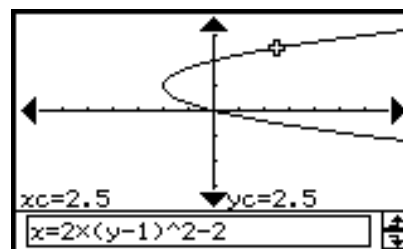

- You can also move the pointer to a particular point by inputting coordinates. Inputting a value while a trace operation is being performed displays a dialog box for inputting a value. After you enter a value, the pointer jumps to the corresponding location when you tap [OK].

Here, input a value for y_c in the case of a parabola that opens horizontally. Input a value for x_c in the case of a parabola that opens vertically. For any other type of conics graph, input a value for t_c in order to graph in parametric format.

- (4) To exit trace, tap **ESC** on the icon panel.

Tip

- While tracing, tapping the displayed coordinate values causes the coordinate values to appear in the message box. You can then copy the coordinates to the clipboard.

4-5 Using G-Solve to Analyze a Conics Graph

The G-Solve menu includes commands that let you perform a variety of different analytical processes on a graph drawn on the Conics Graph window.

Displaying the G-Solve Menu

While there is a graph on the Conics Graph window, tap [Analysis] and then [G-Solve]. You can then use the [G-Solve] menu that appears to perform one of the operations described below.

To obtain this:	Select this [G-Solve] menu item:
Focus of a parabola, ellipse, or hyperbola	Focus
Vertex of a parabola, ellipse, or hyperbola	Vertex
Directrix of a parabola	Directrix
Axis of symmetry of a parabola	Symmetry
Length of the latus rectum of a parabola	Latus Rectum Length
Center point of a circle, ellipse, or hyperbola	Center
Radius of a circle	Radius
Asymptotes of a hyperbola	Asymptotes
Eccentricity of a parabola, ellipse, or hyperbola	Eccentricity
x -intercept	x -Intercept
y -intercept	y -Intercept
x -coordinate for a given y -coordinate	x -Cal
y -coordinate for a given x -coordinate	y -Cal

Tip

- Some commands are available only for certain types of graphs. Any command that is not available for the graph currently displayed on the Conics Graph window has a line through it. A parabola, for example, does not have a center, radius or asymptotes, so there are lines through the [Center], [Radius], and [Asymptotes] commands of the [G-Solve] menu when there is a parabola on the Conics Graph window.

Using G-Solve Menu Commands

The following are some examples of how to perform the Conics application [G-Solve] menu commands.

- **To determine the focus of the parabola $x = 2(y - 1)^2 - 2$**

(1) On the Conics Editor window, input the conics equation and then tap $\boxed{\text{G-Solve}}$ to graph it.

- Here, input the parabolic equation $x = 2(y - 1)^2 - 2$.

(2) Tap [Analysis] and then [G-Solve]. Next, on the submenu that appears, select the command you want.

- To determine the focus for this example, select [Focus].

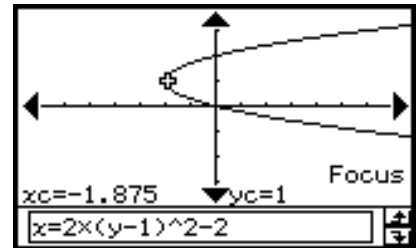

Tip

- An ellipse and hyperbola has two foci. In this case, press the left and right cursor keys or tap the left and right graph controller arrows to toggle the display between the two foci.

The following are the menu operations and sample windows for other commands.

- **To determine the vertices of the ellipse $\frac{(x - 1)^2}{2^2} + \frac{(y - 2)^2}{3^2} = 1$**

[Analysis] - [G-Solve] - [Vertex]

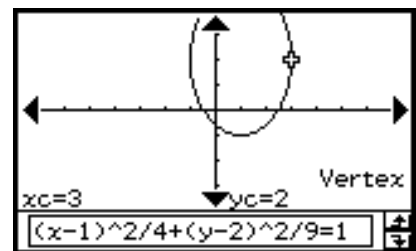

Tip

- An ellipse has four vertices and a hyperbola has two vertices. In these cases, press the left and right cursor keys or tap the left and right graph controller arrows to toggle the display between the vertices.

- To determine the directrix of the parabola $x = 2(y - 1)^2 - 2$

[Analysis] - [G-Solve] - [Directrix]

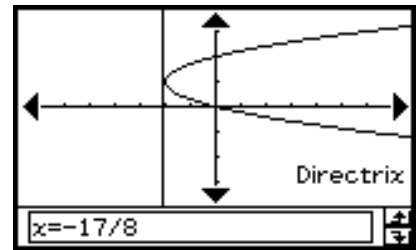

- To determine the axis of symmetry of the parabola $x = 2(y - 1)^2 - 2$

[Analysis] - [G-Solve] - [Symmetry]

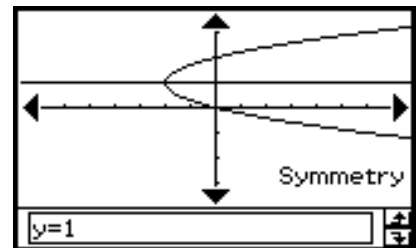

- To determine the latus rectum of the parabola $x = 2(y - 1)^2 - 2$

[Analysis] - [G-Solve] - [Latus Rectum Length]

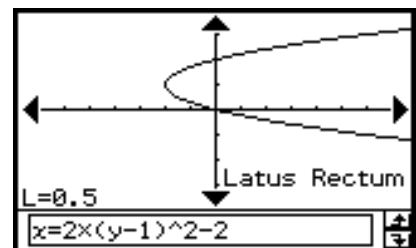

- To determine the center point of the circle $x^2 + y^2 + 4x - 6y + 9 = 0$

[Analysis] - [G-Solve] - [Center]

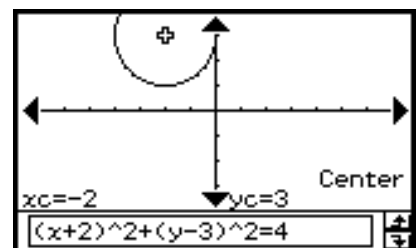

- To determine the radius of the circle $x^2 + y^2 + 4x - 6y + 9 = 0$

[Analysis] - [G-Solve] - [Radius]

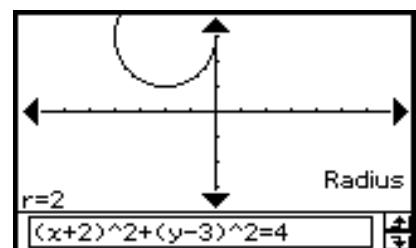

- To determine the asymptotes of the hyperbola $\frac{(x-1)^2}{2^2} - \frac{(y-2)^2}{3^2} = 1$

[Analysis] - [G-Solve] - [Asymptotes]

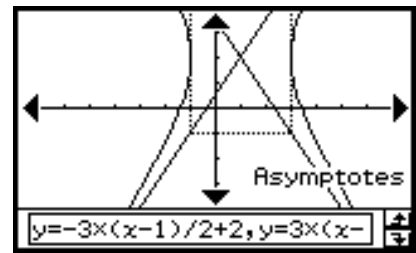

- To determine the eccentricity of the ellipse $\frac{(x-1)^2}{2^2} + \frac{(y-2)^2}{3^2} = 1$

[Analysis] - [G-Solve] - [Eccentricity]

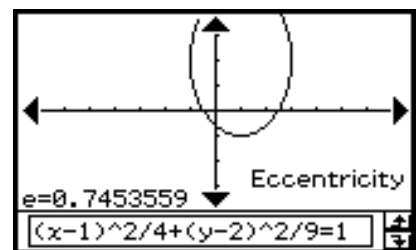

- To determine the x-intercept of the parabola $x = 2(y-1)^2 - 2$

[Analysis] - [G-Solve] - [x-Intercept]

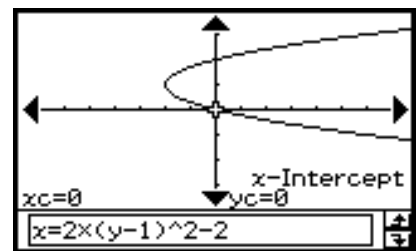

Tip

- When there are two x-intercepts, press the left and right cursor keys or tap the left and right graph controller arrows to toggle the display between them.

- To determine the y-intercept of the ellipse $\frac{(x-1)^2}{2^2} + \frac{(y-2)^2}{3^2} = 1$

[Analysis] - [G-Solve] - [y-Intercept]

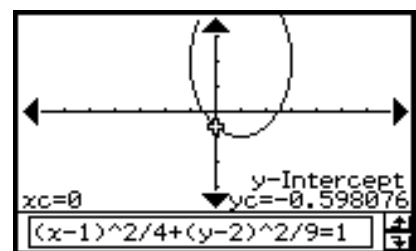

Tip

- When there are two y-intercepts, press the left and right cursor keys or tap the left and right graph controller arrows to toggle the display between them.

- For the hyperbola $\frac{(x-1)^2}{2^2} - \frac{(y-2)^2}{3^2} = 1$, determine the x -coordinate when the y -coordinate is 0

[Analysis] - [G-Solve] - [x-Cal]

Enter Value ✕

y-value:

Tap [OK].

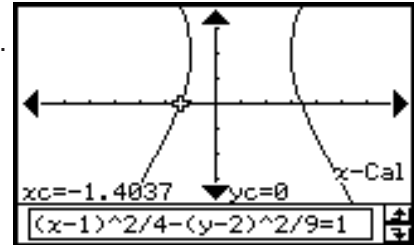

Tip

- When there are two x -coordinates, press the left and right cursor keys or tap the left and right graph controller arrows to toggle the display between them.

- For the hyperbola $\frac{(x-1)^2}{2^2} - \frac{(y-2)^2}{3^2} = 1$, determine the y -coordinate when the x -coordinate is 3

[Analysis] - [G-Solve] - [y-Cal]

Enter Value ✕

x-value:

Tap [OK].

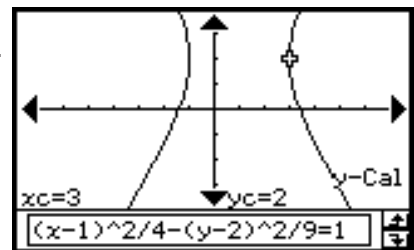

Tip

- When there are two y -coordinates, press the left and right cursor keys or tap the left and right graph controller arrows to toggle the display between them.



Using the 3D Graph Application

The 3D Graph application lets you draw a 3-dimensional graph of an equation in the form $z = f(x, y)$ or of a parametric equation.

- 5-1 3D Graph Application Overview**
- 5-2 Inputting an Expression**
- 5-3 Drawing a 3D Graph**
- 5-4 Manipulating a Graph on the 3D Graph Window**
- 5-5 Other 3D Graph Application Functions**

5-1 3D Graph Application Overview

This section describes the configuration of the 3D Graph application window, and provides basic information about its menus and commands.

Starting Up the 3D Graph Application

Use the following procedure to start up the 3D Graph application.

• ClassPad Operation

On the application menu, tap  3D Graph.

This starts the 3D Graph application and displays the 3D Graph Editor window and the 3D Graph window.

3D Graph Application Window

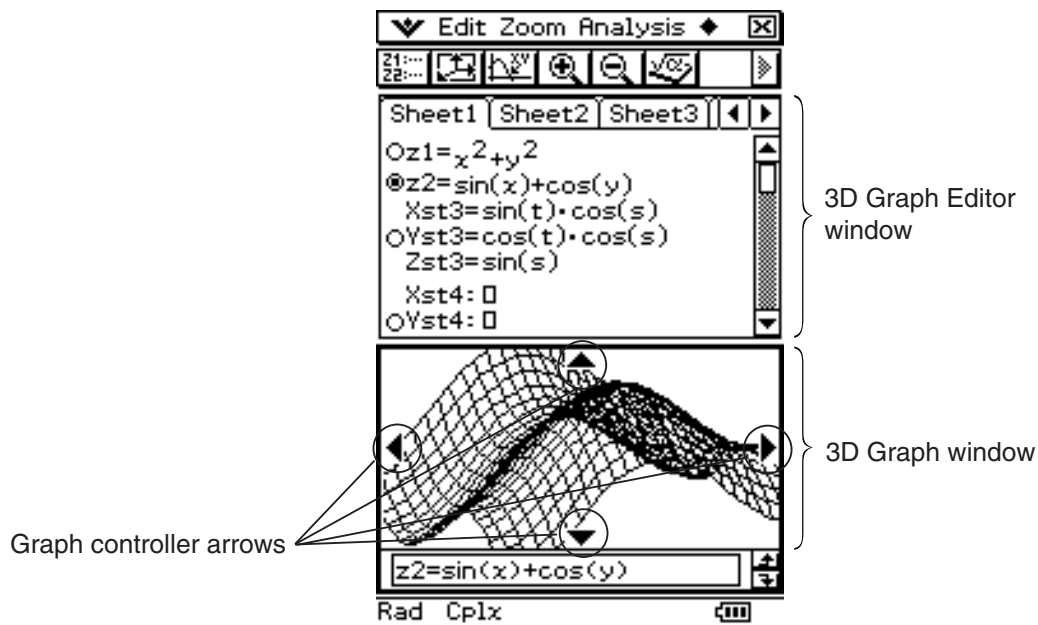

The 3D Graph application has a 3D Graph Editor window and a 3D Graph window. Both of these windows appear on the display when you start up the 3D Graph application. Functions you input on the 3D Graph Editor window are graphed on the 3D Graph window.



- The 3D Graph Editor has five tabbed sheets named Sheet 1 through Sheet 5. Each sheet can contain up to 20 functions. This means you can have up to 100 functions stored in the 3D Graph Editor at one time.
- You can select any one of the expressions on the 3D Graph Editor window and graph it on the 3D Graph window.
- You can tap the graph controller arrows on the 3D Graph window or press the cursor keys to rotate the graph. On the 3D Graph window, you can rotate the graph image by dragging with the stylus.
- When using Trace (page 5-5-1), tap the graph controller arrows or operate the cursor key to move the pointer along the graph.











3D Graph Application Menus and Buttons

This section explains the operations you can perform using the menus and buttons of the 3D Graph application's windows.

- For information about the  menu, see "Using the  Menu" on page 1-5-4.

■ 3D Graph Editor Window Menus and Buttons







The following describes the menu and button operations you can perform while the 3D Graph Editor window is active.

To do this:	Tap this button:	Or select this menu item:
Delete the current selection		Edit - Delete
Cut the selected character string and place it onto the clipboard	—	Edit - Cut
Copy the selected character string to the clipboard	—	Edit - Copy
Paste the contents of the clipboard at the current cursor position in the 3D Graph Editor window	—	Edit - Paste
Select the entire expression you are editing	—	Edit - Select All
Clear all the contents of the 3D Graph Editor window	—	Edit - Clear All
Return the current sheet to its initial default name (Sheet 1 through Sheet 5)	—	Sheet - Default Name
Return the contents and name of the currently active sheet to their initial defaults	—	Sheet - Clear Sheet
Draw a graph		—
Toggle the equation type between $z = f(x, y)$ and a parametric equation	 	—
Display the View Window dialog box (page 5-3-1) to configure 3D Graph window settings		 - View Window
Display the Main application work area window		—
Insert variable s into a parametric equation		—
Insert variable t into a parametric equation		—
Display the Variable Manager (page 1-8-1)	—	 - Variable Manager



■ 3D Graph Window Menus and Buttons

The following describes the menu and button operations you can perform while the 3D Graph window is active.

To do this:	Tap this button:	Or select this menu item:
Enlarge the displayed graph		Zoom - Zoom In
Reduce the size of the displayed graph		Zoom - Zoom Out
View the displayed graph from the x -axis, y -axis, or z -axis	—	Zoom - View- x
	—	Zoom - View- y
	—	Zoom - View- z
Return the 3D Graph window to its initial default state	—	Zoom - View-Init
Display the coordinates at a particular point on a 3D graph		Analysis - Trace
Write text on the Graph window • See “To write text on the Graph window” on page 3-6-2, and “To clear figures inserted using the Sketch menu” on page 3-6-5.	—	Analysis - Sketch
Calculate a z -value for given x - and y -values, or s - and t -values, on the displayed graph	—	Analysis - z -Cal
Automatically rotate a graph in the specified direction (Left → Right, Right → Left, Top → Bottom, Bottom → Top) for about 30 seconds	—	◆ - Rotating
Save a graph as image data (page 3-2-10)	—	◆ - Store Picture
Recall the image of a graph (page 3-2-10)	—	◆ - Recall Picture
Re-draw a graph	—	◆ - ReDraw
Make the 3D Graph Editor window active		—
Display the View Window dialog box (page 5-3-1) to configure 3D Graph window settings		▼ - View Window
Display the Main application work area window		—
Display the Variable Manager (page 1-8-1)	—	▼ - Variable Manager



3D Graph Application Status Bar

The status bar at the bottom of the 3D Graph application shows the current angle unit setting and [Complex Format] setting (page 1-9-5).

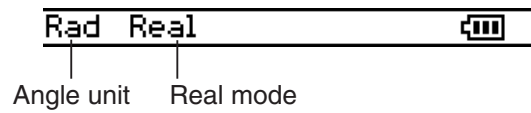

If you see this:	It means this:
Rad	The angle unit setting is radians.
Deg	The angle unit setting is degrees.
Gra	The angle unit setting is grads.
Cplx	The Complex (complex number calculation) mode is selected.
Real	The Real (real number calculation) mode is selected.



5-2 Inputting an Expression

Use the 3D Graph Editor window to input 3D Graph application expressions.

Using 3D Graph Editor Sheets

The 3D Graph Editor has five tabbed sheets named Sheet 1 through Sheet 5. Each sheet can contain up to 20 functions. This means you can have up to 100 functions stored in the 3D Graph Editor at one time. 3D Graph Editor window sheet operations are similar to the sheet operations of the Graph & Table application. For more information, see “Using Graph Editor Sheets” on page 3-3-1.

Tip

- The commands used to perform sheet operations in the 3D Graph application are slightly different to those in the Graph & Table application, as described below.

To do this:	Execute this command in the Graph & Table application:	Execute this command in the 3D Graph application:
Return the name of the active sheet to its initial default	◆ - Sheet - Default Name	Sheet - Default Name
Return the contents and name of the currently active sheet to their initial defaults	◆ - Sheet - Clear Sheet	Sheet - Clear Sheet

- Also note that the Graph & Table application allows simultaneous graphing of multiple functions, as long as they are on the same sheet. With the 3D Graph application, however, you can graph only one function at a time.



Storing a Function

You can input an equation of the form $z = f(x, y)$ or a parametric equation.

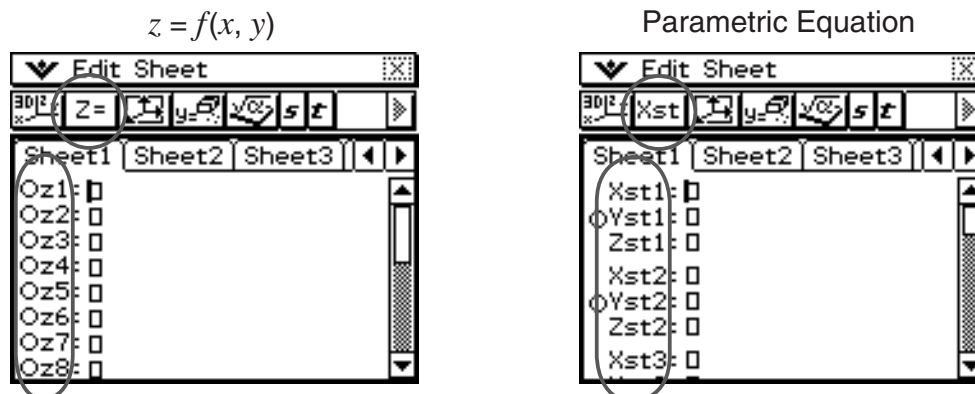

Example: To store $z = x^2 + y^2$ in line $z1$

• ClassPad Operation

(1) On the application menu, tap .

- This starts up the 3D Graph application and displays the initial screen of the active 3D Graph Editor window.

(2) Tap line $z1$ on the 3D Graph Editor window, and input $x^2 + y^2$.



(3) Press .

- This stores the expression you input and selects it, which is indicated by the button next to it changing to .

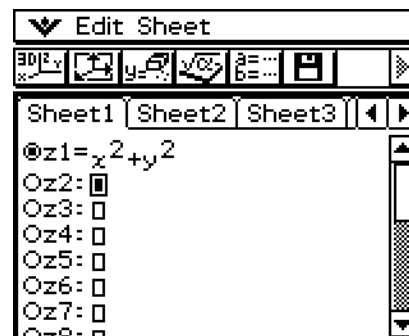

(4) To graph the function you just input, tap .

- For information about graphing, see “5-3 Drawing a 3D Graph”.

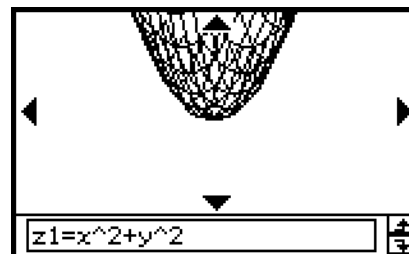

Tip

- You can also use drag and drop to input an expression displayed on the Main application window into the 3D Graph Editor window. To do this, perform the same steps as those for the Graph & Table application. For more information, see “Quick Graphing of an Expression Using Drag and Drop” on page 3-3-9.

5-3 Drawing a 3D Graph

This section explains how to draw a 3D graph, as well as how to change the angle of a graph and how to rotate a graph.



Configuring 3D Graph View Window Parameters

Use the 3D Graph View Window to specify maximum and minimum values for the x -axis, y -axis, z -axis, s -variable, and t -variable. You can also specify the number of lines you would like for drawing the grid.

- For the x grid enter the number of lines you would like drawn within the interval from x_{\min} to x_{\max} . For example, if $x_{\min} = -3$, $x_{\max} = 3$ and $x_{\text{grid}} = 15$, 15 almost vertical lines will be used to display your graph. The y grid lines will be almost horizontal.
- After drawing a 3D graph, pressing the \ominus key cycles the 3D Graph [Axes] setting (page 1-9-8) in the following sequence: “Off” \rightarrow “On” \rightarrow “Box” \rightarrow “Off”, and so on.

Before drawing a graph, be sure to first configure View Window parameters as required to ensure proper display of the graph.

• ClassPad Operation

- (1) On the application menu, tap .
 - This starts up the 3D Graph application and displays the initial screen of the active 3D Graph Editor window.
- (2) Tap  to display the View Window dialog box.
- (3) Tap the “3D” option button so the option is selected.
- (4) Configure the View Window parameters as described below.
 - Press \blacktriangledown to move the cursor and input an appropriate value for each parameter.

Use this item:	To configure this View Window parameter:	Initial default
x_{\min}	Minimum x -axis value	-3
x_{\max}	Maximum x -axis value	3
x_{grid}	Number of grid lines used for x -axis direction	25
y_{\min}	Minimum y -axis value	-3
y_{\max}	Maximum y -axis value	3
y_{grid}	Number of grid lines used for y -axis direction	25
z_{\min}	Minimum z -axis value	-3
z_{\max}	Maximum z -axis value	3
angle θ	Clockwise angle of x -axis	20
angle ϕ	Eye position relative to the plane created by the x -axis and y -axis, and the angle of the z -axis	70
s_{\min}	Minimum s -variable value	-3.1415926535
s_{\max}	Maximum s -variable value	3.14159265358
t_{\min}	Minimum t -variable value	-3.1415926535
t_{\max}	Maximum t -variable value	3.14159265358

5-3-2
Drawing a 3D Graph

- The following are the allowable ranges for the indicated View Window parameters: xgrid and ygrid: 2 to 50; angle θ : $-180 < \theta \leq 180$; angle ϕ : 0 to 360.
 - The angle parameters, θ and ϕ , are always degrees, regardless of the current [Angle] setting of the Basic Format dialog box (page 1-9-5).
- (5) After all the parameters are the way you want, tap [OK].
- This closes the View Window dialog box.

■ 3D Graphs

The following are examples of the 3D graph $z = xy$ using a number of different 3D View Window setups. View Window parameters that are not specified are set to the initial default values.

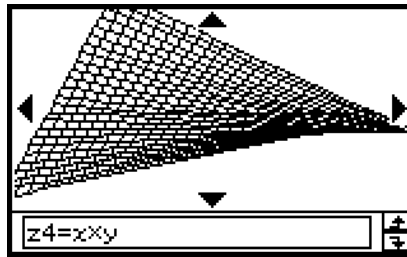

xmin/ymin = -1, xmax/ymax = 1

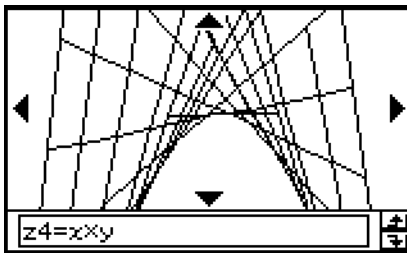

xgrid = 10, ygrid = 10

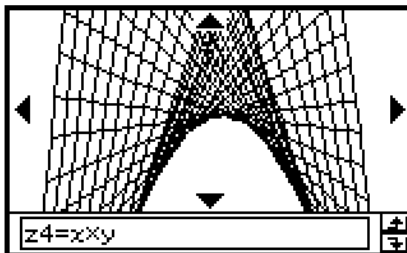

Initial defaults

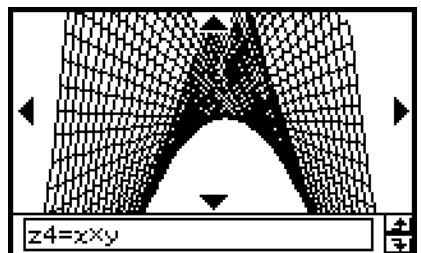

xgrid = 40, ygrid = 40

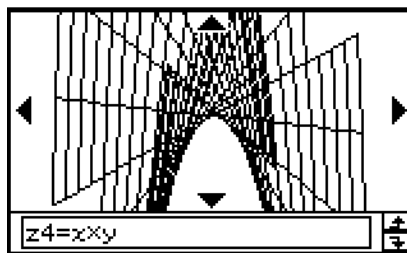

xmin/ymin = -5, xmax/ymax = 5

Important!

- As is evident from the above sample screenshots, the greater the xgrid and ygrid values, the more detailed the graph. Also note, however, that larger values require more calculation, which means that the graphing operation takes more time.
- Graphing may be impossible if the xgrid and ygrid values are too small.

3D Graph Example

Example 1: To graph the hyperbolic paraboloid $z = x^2/2 - y^2/8$.

• ClassPad Operation

- (1) In the 3D Graph application, make the 3D Graph Editor window active.
- (2) Tap  to display the View Window dialog box, and then configure the parameters shown below.

xmin = -3 xmax = 3 xgrid = 25
 ymin = -3 ymax = 3 ygrid = 25
 angle θ = 45 angle ϕ = 70

- Except for angle θ , all of the above settings are initial defaults.
- After everything is the way you want, tap [OK] to close the View Window dialog box.

- (3) Tap line z2 on the 3D Graph Editor window, and then input $x^2/2 - y^2/8$.



- (4) Press .

- This stores the expression you input and selects it, which is indicated by the button changing to “”.

- (5) Tap  to graph the expression.

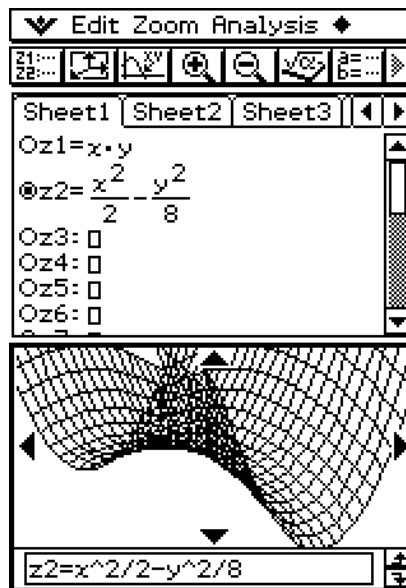

- Here, you can use the cursor key to rotate the graph on the display. On the 3D Graph window, you can rotate the graph image by dragging with the stylus. For more information, see “5-4 Manipulating a Graph on the 3D Graph Window”.

Example 2: To graph a parametric equation

• **ClassPad Operation**

(1) In the 3D Graph application, make the 3D Graph Editor window active.

(2) Tap $\boxed{Z=}$ to specify input of a parametric equation.

(3) Tap line Xst1, and then input $\sin(t) \times \cos(s)$.

$\boxed{\text{Keyboard}} \boxed{\text{mth}} \boxed{\text{TRIG}} \boxed{\sin} \boxed{t} \boxed{)} \boxed{\times} \boxed{\cos} \boxed{s} \boxed{)}$

(4) Press $\boxed{\text{EXE}}$.

(5) In line Yst1 input $\cos(t) \times \cos(s)$.

$\boxed{\cos} \boxed{t} \boxed{)} \boxed{\times} \boxed{\cos} \boxed{s} \boxed{)}$

(6) Press $\boxed{\text{EXE}}$.

(7) In line Zst1 input $\sin(s)$.

$\boxed{\sin} \boxed{s} \boxed{)}$

(8) Press $\boxed{\text{EXE}}$.

(9) Tap $\boxed{\text{3D}} \boxed{\text{EXE}}$ to graph the parametric equation.

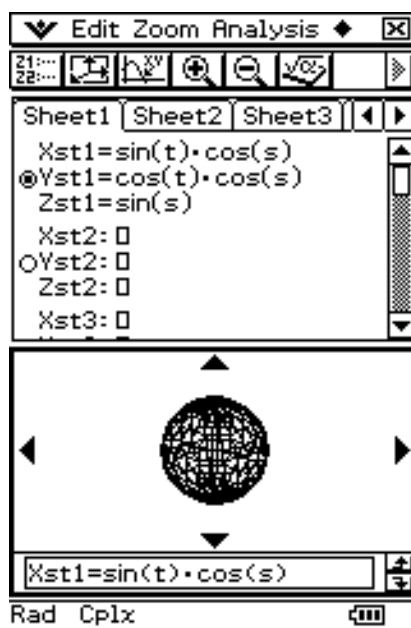

■ Selecting the Function to be Graphed

The 3D Graph application lets you graph only one function at a time. When you have more than one expression input on the 3D Graph Editor window, you need to select the one you want to graph.

Tapping the “○” button next to a function changes the button to “●”, which indicates that the function is selected. Press **EXE** to enable graphing.

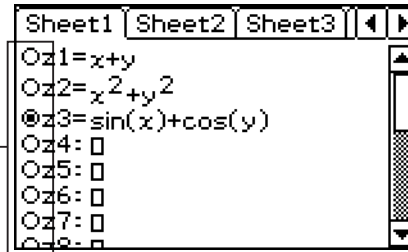

Tip

- Whenever you input a new function on the 3D Graph Editor window, the new function is selected automatically for graphing after you press **EXE**.

■ Controlling the Format of the 3D Graph

Tapping  and [3D Format] displays the 3D Format dialog box, which you can use to control the graph axis type, display of axis labels, and other format settings.

- For details about the settings you can configure on the 3D Format dialog box, see “3D Format Dialog Box” on page 1-9-8.

5-4 Manipulating a Graph on the 3D Graph Window

This section describes how to enlarge and reduce the size of a graph, how to change the eye position to view the graph along a particular axis, and how to perform other operations like automatic rotation.

Important!

- All of the operations described in this section can be performed only while the 3D Graph window is active.

Enlarging and Reducing the Size of a Graph

A displayed 3D graph can be zoomed so it is enlarged or reduced. The zoom operation is always performed based on the center of the Graph window. You cannot select the area to be zoomed.

• To enlarge a graph

Perform any one of the following operations:

- Tap .
- Tap [Zoom] and then [Zoom In].
- Press the \oplus key.

• To reduce the size of a graph

Perform any one of the following operations:

- Tap .
- Tap [Zoom] and then [Zoom Out].
- Press the \ominus key.

Starting from the normal size, you can enlarge a graph 14 steps or reduce its size 15 steps.

Switching the Eye Position

The following items describe how to change the eye position and view a displayed 3D graph along a particular axis. All of the example displays below show the graph of the expression $z = x^2/2 - y^2/8$, which we graphed under “3D Graph Example” on page 5-3-3.

- To view the graph facing the x -axis, tap [Zoom] and then [View- x], or press the \otimes key.

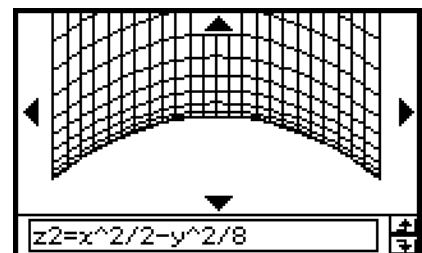

- To view the graph facing the y -axis, tap [Zoom] and then [View- y], or press the (y) key.

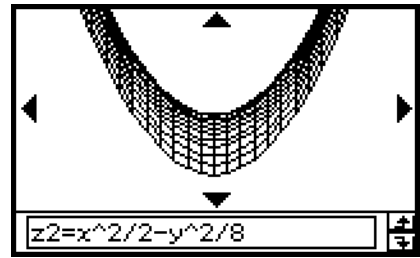

- To view the graph facing the z -axis, tap [Zoom] and then [View- z], or press the (z) key.

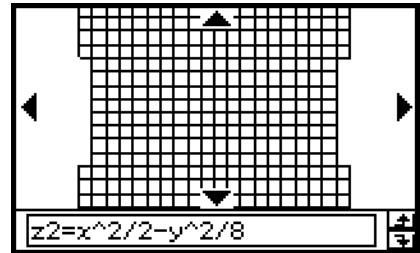

Rotating the Graph Manually

Use the procedures described below to rotate the displayed graph manually.

■ Using the Stylus to Rotate a Graph

Drag the stylus on the 3D Graph window in the direction you want to rotate the graph.

■ Using the Cursor Keys and Graph Controller Arrow to Rotate a Graph



To do this:	Do this:
Rotate the graph to the left	Press the left cursor key or tap the left graph controller arrow.
Rotate the graph to the right	Press the right cursor key or tap the right graph controller arrow.
Rotate the graph upwards	Press the up cursor key or tap the up graph controller arrow.
Rotate the graph downwards	Press the down cursor key or tap the down graph controller arrow.

- Holding down a key will rotate the graph continuously.

Rotating a Graph Automatically

You can use the following procedure to rotate a graph automatically for about 30 seconds.

• ClassPad Operation

- (1) To start automatic graph rotation, tap  and then [Rotating].
 - (2) On the submenu that appears, select the rotation direction you want:
[Left → Right], [Right → Left], [Top → Bottom], or [Bottom → Top].
- Rotation continues for about 30 seconds and then stops automatically. You can also stop automatic rotation by pressing the  key or tapping  on the icon panel.

Initializing the Graph Window

To return the 3D Graph window to its initial default settings, including its View Window settings, tap [Zoom] and then [View-Init].



5-5 Other 3D Graph Application Functions

Using Trace to Read Graph Coordinates

Starting the trace operation causes a crosshair pointer to appear on the graph. You can then press a cursor key or tap the graph controller arrows to move the pointer to the location you want, and read the coordinates that appear on the display. To start the trace operation and display the pointer, make the 3D Graph window active, and then tap , or tap [Analysis] and then [Trace].

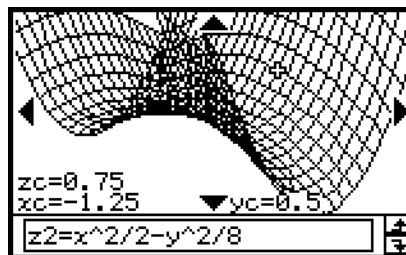

- Each time you press the cursor key or tap a graph controller arrow, the pointer moves the distance specified by the [grid] value on the 3D View Window dialog box.
- Inputting a value while a trace operation is being performed displays a dialog box for inputting an x - and y -coordinate. Inputting values for each of the coordinates on this dialog box causes the pointer to jump to the corresponding location when you tap [OK].

To cancel the trace operation, tap **ESC** on the icon panel.

Tip

- The initial default setting for the coordinate display is rectangular coordinates (Rectangular). Tapping  and [3D Format] displays the 3D Format dialog box, which you can use to select polar coordinates (Polar) or to hide coordinate values entirely.
- For details about the settings you can configure on the 3D Format dialog box, see “3D Format Dialog Box” on page 1-9-8.

Inserting Text into a 3D Graph Window

You can insert text into a 3D Graph window and delete it as required.

For more information, see “To write text on the Graph window” on page 3-6-2, and “To clear figures inserted using the Sketch menu” on page 3-6-5.

Calculating a z -value for Particular x - and y -values, or s - and t -values

Use the following procedure to calculate a z -value for given x - and y -values on the displayed graph.

• ClassPad Operation

- (1) Draw the graph and make the 3D Graph window active.
- (2) Tap [Analysis], and then [z-Cal].
 - This displays a dialog box for specifying the x - and y -values.
- (3) Enter values for x and y , and then tap [OK].
 - This displays the x -, y -, and z -coordinate values on the 3D Graph window.

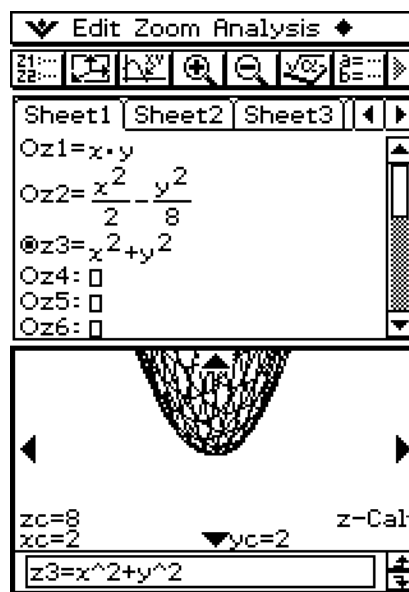

- Inputting a graph value while "z-Cal" is on the display while cause a dialog box to appear for specifying an x - and y -value, or an s - and t -value. You can use this dialog box to specify other x - and y -values, or s - and t -values.
- To cancel the z -Cal operation, tap **ESC** on the icon panel.

Using Drag and Drop to Draw a 3D Graph

Dropping an equation of the form $z = f(x, y)$ into the 3D Graph window will graph the equation.

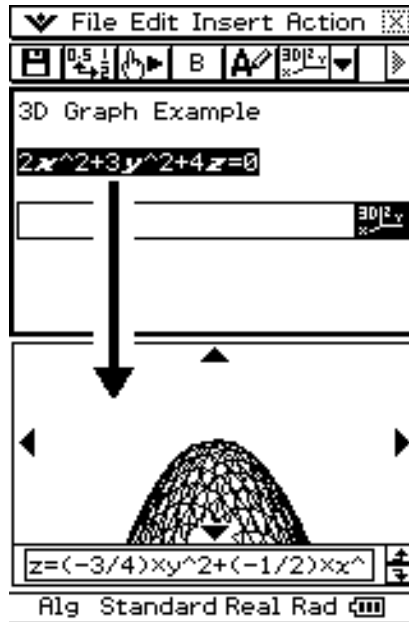

Chapter 6

6

Using the Sequence Application

The Sequence application provides you with the tools you need to work with explicit sequences and recursive type sequences.

- 6-1 **Sequence Application Overview**
- 6-2 **Inputting an Expression in the Sequence Application**
- 6-3 **Recursive and Explicit Form of a Sequence**
- 6-4 **Using LinkTrace**
- 6-5 **Drawing a Cobweb Diagram**

6-1 Sequence Application Overview

This section describes the configuration of the Sequence application window, and provides basic information about its menus and commands.

Starting up the Sequence Application

Use the following procedure to start up the Sequence application.

- **ClassPad Operation**

On the application menu, tap  Sequence.

This starts the Sequence application and displays the Sequence Editor window and the Table window.

Sequence Application Window

When you start up the Sequence application, two windows appear on the display screen: the Sequence Editor window and Table window.

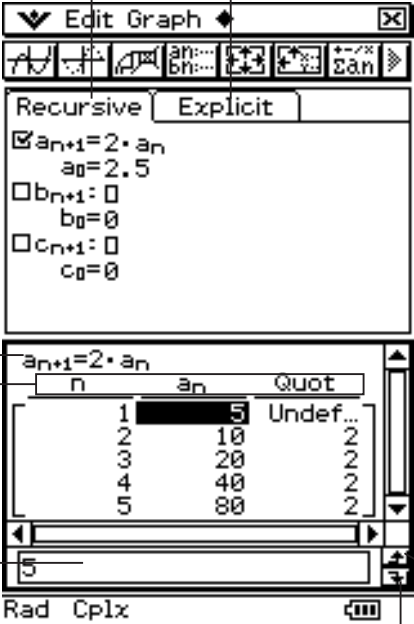

The screenshot shows the Sequence Application window with two main sections:

- Sequence Editor window:** Contains tabs for "Recursive" and "Explicit". Under "Recursive", there are three rows of equations:
 - $a_{n+1} = 2 \cdot a_n$
 - $a_0 = 2.5$
 - $b_{n+1} = 0$
 - $b_0 = 0$
 - $c_{n+1} = 0$
 - $c_0 = 0$
- Table window:** Displays a table with columns "n", "a_n", and "Quot". The title bar shows the equation $a_{n+1} = 2 \cdot a_n$. The table content is:

n	a _n	Quot
1	5	Undef...
2	10	2
3	20	2
4	40	2
5	80	2

Additional annotations include:

- "Tabs: Select either [Recursive] or [Explicit]." pointing to the tabs in the Sequence Editor window.
- "(a) Title: Shows the equation used in the calculations. The title is not displayed when an item in column n is selected." pointing to the title bar of the Table window.
- "(b) Column names" pointing to the column headers in the Table window.
- "Message box: Shows the value of the currently selected table cell." pointing to a message box containing the value "5".
- "Tap to copy the area selected in the message box to the clipboard." pointing to a copy icon in the message box.
- "Tap to paste the clipboard contents at the current cursor position in the message box." pointing to a paste icon in the message box.

Sequence Application Menus and Buttons

This section explains the operations you can perform using the menus and buttons of the Sequence application's windows.

- For information about Format related items on  menu, see "Application Format Settings" on page 1-9-4.

■ Sequence Editor Window Menus and Buttons

Menu

To do this:	Select this  menu item:
Display the Sequence Editor window	Sequence Editor
Display the Table window	Table
Display the Graph window	Graph
Display the Sequence RUN window	Sequence RUN
Start up the Main application	Main
Display the soft keyboard	Keyboard

Edit Menu

To do this:	Select this Edit menu item:
Cut the currently selected object and place it onto the clipboard*	Cut
Copy the currently selected object and place it onto the clipboard*	Copy
Paste the current clipboard contents onto the screen	Paste
Select all objects on the screen*	Select All
Clear the active window	Clear All

* These commands are available only for line edit operation when the Graph or Table window is active.

Type Menu

To do this:	Select this Type menu item:
Specify the type of expression you are inputting when the [Recursive] tab is displayed	a_{n+1} Type a_0
	a_{n+1} Type a_1
	a_{n+2} Type a_0, a_1
	a_{n+2} Type a_1, a_2

n , a_n Menu

To do this:	Select this n , a_n menu item:
Input a recursion expression term when a_{n+1} Type is selected on the [Recursive] sheet	n , a_n , b_n , or c_n
Input a recursion expression term when a_{n+2} Type is selected on the [Recursive] sheet	n , a_n , b_n , c_n , a_{n+1} , b_{n+1} , or c_{n+1}
Input a recursion expression term when the [Explicit] tab is selected	n , a_nE , b_nE , or c_nE

◆ Menu

To do this:	Select this ◆ menu item:
Turn display of sequence table subtotals on and off	Σ display - On/ Off
After drawing a graph, turn display of generated expressions on and off	Set Sequence - On/ Off
Require pressing of to display expression	Set Sequence - StepDisp
Clear the contents of the currently active tab sheet	Clear Sheet

Buttons



To do this:	Tap this button:
Create an ordered pair table	
Create an arithmetic sequence table	
Create a geometric sequence table	
Create a progression of difference table	
Create a Fibonacci sequence table	
Draw a cobweb diagram on a graph	
Display the Sequence RUN window	
Specify $a_{n+1}a_0$ as the recursion type	
Specify $a_{n+1}a_1$ as the recursion type	
Specify $a_{n+2}a_0a_1$ as the recursion type	
Specify $a_{n+2}a_1a_2$ as the recursion type	
Input term- n of a recursion expression (Appears only when the [Explicit] tab is selected.)	
Delete the recursion expression in the current active line	
Display the Sequence Table Input dialog box	

■ Sequence Table Window Menus and Buttons

Edit Menu

The commands on the sequence Table window [Edit] menu are identical to those for the Sequence Editor window [Edit] menu described on page 6-1-2.





Graph Menu

To do this:	Tap this button:	Or select this Graph menu item:
Draw a connect type graph		G-Connect
Draw a plot type graph		G-Plot

◆ Menu

To do this:	Select this ◆ menu item:
Save the contents of a table to a list	Table to List
Regenerate the currently displayed table	ReTable
Delete the currently displayed table	Delete Table
Execute a table and graph link trace	Link

Buttons

To do this:	Tap this button:
Display the Sequence Editor window	
Display the Sequence RUN window	
Display the Sequence Table Input dialog box	
Display the View Window dialog box	
Draw a cobweb diagram on a graph	

■ Sequence Graph Window Menus and Buttons

Edit Menu

The commands on this menu are identical to those for the Sequence Editor window [Edit] menu described on page 6-1-2.

Zoom Menu

The commands on this menu are identical to those for the Graph & Table application [Zoom] menu described on page 3-1-4.





Analysis Menu

The [Analysis] menu includes both [Trace] and [Sketch] items. For details about [Trace] and [Sketch], see page 3-1-5.

◆ Menu

The commands on this menu are identical to those for the Graph & Table application ◆ menu described on page 3-1-3.

Buttons

To do this:	Tap this button:
Create a sequence table	
Display the Sequence Editor window	
Display the View Window dialog box	
Display the Sequence Table Input dialog box	
Display the Sequence RUN window	

■ Sequence RUN Window Menus and Buttons

Edit Menu

The commands on the Sequence RUN window [Edit] menu are identical to those for the Sequence Editor window [Edit] menu described on page 6-1-2.

n, a_n Menu

To do this:	Select one of these n, a_n menu items:
Input a recursion expression term	$n, a_n, b_n, c_n, a_{n+1}, b_{n+1}, c_{n+1}, a_{n+2}, b_{n+2}, c_{n+2}, a_nE, b_nE, \text{ or } c_nE$





a_0, a_1 Menu

To do this:	Select one of these a_0, a_1 menu items:
Input a recursion system variable	$a_0, a_1, a_2, b_0, b_1, b_2, c_0, c_1, \text{ or } c_2$

Calc Menu

To do this:	Select this Calc menu items:
Input the “rSolve” function	rSolve
Input the “ Σ ” function	Σ

Buttons

To do this:	Tap this button:
Create a sequence table	
Display the Sequence Editor window	
Display the View Window dialog box	
Display the Sequence Table Input dialog box	



Sequence Application Status Bar

The status bar at the bottom of the Sequence application shows the current angle unit setting and [Complex Format] setting (page 1-9-5).

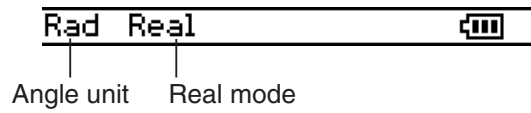

If you see this:	It means this:
Rad	The angle unit setting is radians.
Deg	The angle unit setting is degrees.
Gra	The angle unit setting is grads.
Cplx	The Complex (complex number calculation) mode is selected.
Real	The Real (real number calculation) mode is selected.



6-2 Inputting an Expression in the Sequence Application

In the Sequence application, you input expressions using menus and buttons, without using the soft keyboard at the bottom of the window.

Inputting Data on the Sequence Editor Window

To input an expression, tap the input location you want ((a), (b), or (c)) to locate the cursor there. To input a recursion term, tap the $[n, a_n]$ menu and then tap the term you want. If the [Explicit] tab is displayed, you can also use the toolbar's $[n]$ to input a term- n .

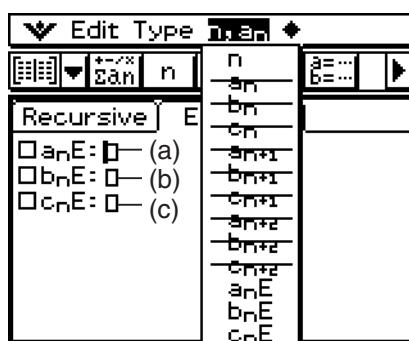

Inputting Data on the Sequence RUN Window

As with the Sequence Editor window, tap $[n, a_n]$ to display the Sequence RUN window and use the $[n, a_n]$ menu to input recursion expression terms. You can also use the $[a_0, a_1]$ menu to input system variables ranging from a_0 to c_2 .

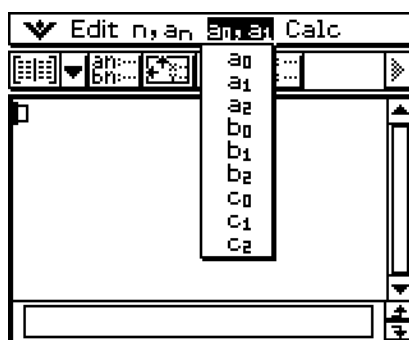

Tip

- You can also input recursion expression terms using the $[mth]$ keyboard's $[OPTN]$ key set.
- You can input recursion system variables (a_0 , $a_n E$, etc.) by tapping the $[cat]$ tab on the soft keyboard to display the catalog keyboard. Next, tap the "Form" down arrow button, and then select [Sys].

6-3 Recursive and Explicit Form of a Sequence

ClassPad supports use of three types of sequence expressions: $a_{n+1}=$, $a_{n+2}=$ and $a_n\bar{E}$.

Generating a Number Table

In addition to ordered pair tables, the Sequence application provides you with the means to generate arithmetic sequence tables*¹, geometric sequence tables*², progression of difference tables*³, and Fibonacci sequence tables*⁴.

*¹ sequence table for determining if sequence is an arithmetic sequence

*² sequence table for determining if sequence is a geometric sequence

*³ sequence table for determining if sequence is a progression of difference



*⁴ sequence table for determining if sequence is a Fibonacci sequence

Example: To create a table (Fibonacci sequence table) for the recursion

$$a_{n+2} = a_{n+1} + a_n, a_1 = 1, a_2 = 1$$

• ClassPad Operation

(1) Start up the Sequence Editor.

- If you have another application running, tap  and then .
- If you have the Sequence application running, tap  and then [Sequence Editor].

(2) Tap the [Recursive] tab.

(3) Specify the recursion type by tapping [Type] and then [a_{n+2} Type a_1, a_2].

(4) Input the recursion expression.

- Tap the input box to the right of a_{n+2} ., and then use the procedures under “6-2 Inputting an Expression in the Sequence Application” to input the following.

$$[n, a_n] [a_{n+1}] \oplus [n, a_n] [a_n] \ominus$$

(5) Input the initial value.

$$\text{1} \ominus \text{1} \ominus$$

(6) Tap .

- This causes the Sequence Table Input dialog box to appear.

(7) Input the n -value range as shown below, and then tap [OK].

Start:1 End:5

(8) Tap the down arrow button next to , and then select $\begin{matrix} c_3 \\ a+b \end{matrix}$ to create the table.

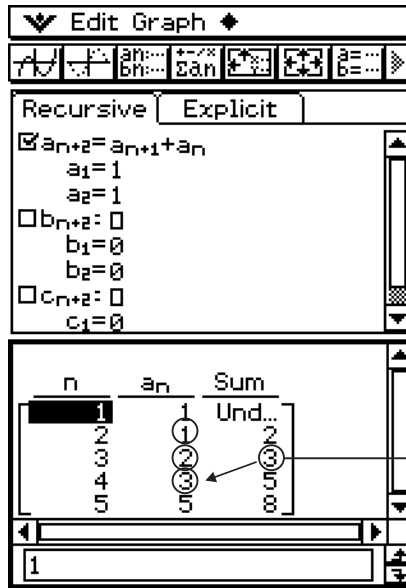

3 = 2 + 1

In the above example, “4 Cells” is selected for the [Cell Width Pattern] setting of the Graph Format dialog box (page 1-9-7).

Other Table Types

The following show what the window looks like after you generate other types of tables.

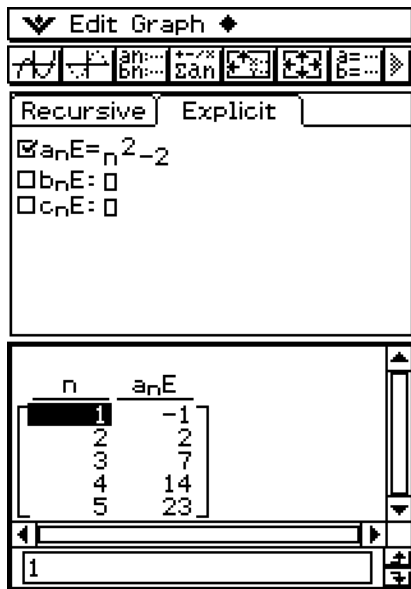

Ordered Pair Table

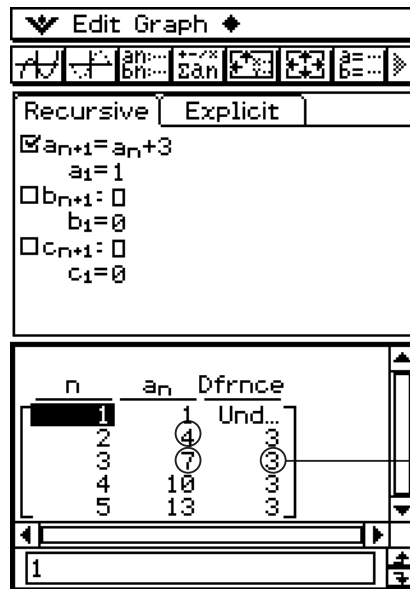

Arithmetic Sequence Table

3 = 7 - 4

Edit Graph		
Recursive Explicit		
<input checked="" type="checkbox"/> $a_{n+1} = 3 \cdot a_n$		
$a_1 = 2$		
<input type="checkbox"/> $b_{n+1} = 0$		
$b_1 = 0$		
<input type="checkbox"/> $c_{n+1} = 0$		
$c_1 = 0$		
n	a_n	Quot
1	2	Und...
2	6	
3	18	3
4	54	3
5	162	3

Geometric Sequence Table

$$3 = 18 \div 6$$

Edit Graph			
Recursive Explicit			
<input checked="" type="checkbox"/> $a_{n+1} = 2 \cdot a_n + 2$			
$a_1 = 3$			
<input type="checkbox"/> $b_{n+1} = 0$			
$b_1 = 0$			
<input type="checkbox"/> $c_{n+1} = 0$			
$c_1 = 0$			
n	a_n	Dfrnce	Quot
1	3	Und...	Und...
2	8	5	Und...
3	18	10	2
4	38	20	2
5	78	40	2

Progression of Difference Table

$$5 = 8 - 3$$

$$2 = 20 \div 10$$



Graphing a Recursion

An expression can be graphed as a connect type graph (G-Connect) or a plot type graph (G-Plot).

Example: To graph $a_{n+1} = 2a_n + 1$, $a_1 = 1$

• ClassPad Operation

(1) Start up the Sequence Editor.

- If you have another application running, tap  and then .
- If you have the Sequence application running, tap  and then [Sequence Editor].

(2) Tap the [Recursive] tab.

(3) Specify the recursion type by tapping [Type] and then [a_{n+1} Type a_1].

(4) Input the recursion expression.

- Tap the input box to the right of a_{n+1} :, and then use the procedures under “6-2 Inputting an Expression in the Sequence Application” to input the following.

$$\text{2} [n, a_n] [a_n] \text{+} \text{1} \text{EXE}$$

(5) Input the initial value.

$$\text{1} \text{EXE}$$

(6) Tap  and then [View Window].

- This displays a dialog box for configuring View Window settings.

(7) Configure View Window settings as shown below.

xmin = 0 xmax = 6 xscale = 1 xdot: (Specify auto setting.)
 ymin = -15 ymax = 65 yscale = 5 ydot: (Specify auto setting.)

(8) After everything is the way you want, tap [OK].

(9) Tap the down arrow button next to , and then select  to create the table.

(10) Perform one of the following steps to draw the type of graph you want.

- To draw a connect type graph, tap .

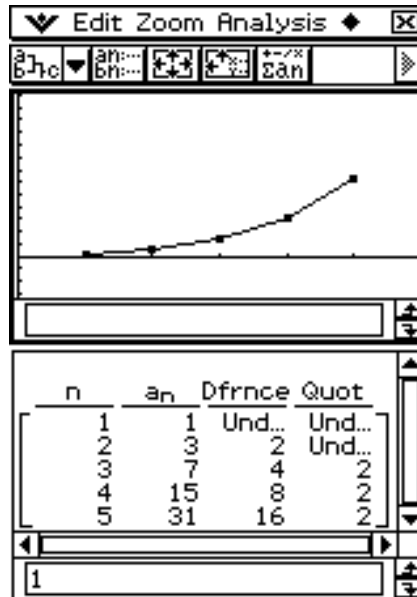

- To draw a plot type graph, tap .

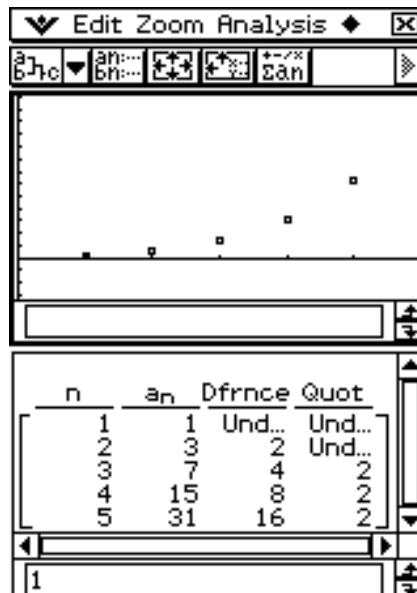

In the above example, "4 Cells" is selected for the [Cell Width Pattern] setting of the Graph Format dialog box (page 1-9-7).



Determining the General Term of a Recursion Expression

The following procedure converts the sequence expressed by a recursion expression to the general term format $a_n = f(n)$.

Example: To determine the general term of the recursion expression $a_{n+1} = a_n + 2$, $a_1 = 1$

• ClassPad Operation

(1) Start up the Sequence Editor.

- If you have another application running, tap  and then .
- If you have the Sequence application running, tap  and then [Sequence Editor].

(2) Tap (or press) , [Sequence RUN], [Calc], [rSolve], [n, a_n], [a_{n+1}], \ominus , [n, a_n], [a_n], \oplus , $\textcircled{2}$, $\textcircled{1}$, [a_0, a_1], [a_1], \ominus , $\textcircled{1}$, and then $\textcircled{1}$.

(3) Press $\textcircled{\text{EXE}}$.

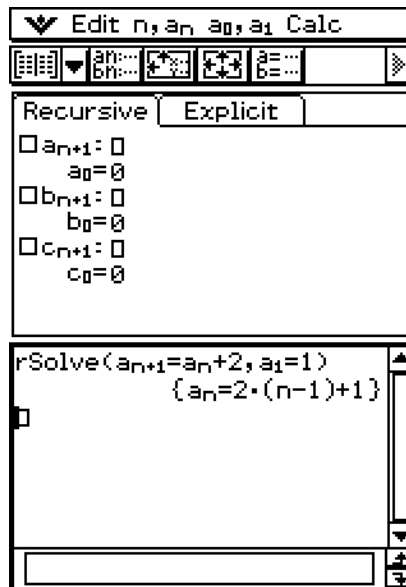

• About rSolve

The rSolve function returns the explicit formula of a sequence that is defined in relation to one or two previous terms, or a system of recursive formulas.

Syntax: rSolve (Eq, initial condition-1[, initial condition-2] [])

rSolve ({Eq-1, Eq-2}, {initial condition-1, initial condition-2} []) (Eq: Equation)

Example: To obtain the n -th term of a recursion formula $a_{n+1} = 3a_n - 1$ with the initial conditions $a_1 = 1$

$$\text{rSolve}(a_{n+1}=3a_n-1, a_1=1) \\ \left\{ a_n = \frac{3^{n-1}}{2} + \frac{1}{2} \right\}$$

Example: To obtain the n -th term of a recursion formula $a_{n+2} - 4a_{n+1} + 4a_n = 0$ with the initial conditions $a_1 = 1$, $a_2 = 3$

$$\text{rSolve}(a_{n+2}-4a_{n+1}+4a_n=0, a_1=1, a_2=3) \\ \left\{ a_n = \frac{2^n \cdot (n+1)}{4} \right\}$$

Example: To obtain the n -th terms of a system of recursion formulas $a_{n+1} = 3a_n + b_n$,
 $b_{n+1} = a_n + 3b_n$ with the initial conditions $a_1 = 2$, $b_1 = 1$

$$\text{rSolve}(\{a_{n+1}=3a_n+b_n, b_{n+1}=a_n+3b_n\}, \{a_1=2, b_1=1\})$$

$$\left\{ a_n = \frac{3 \cdot 4^{n-1} + 2^{n-1}}{2}, b_n = \frac{3 \cdot 4^{n-1} - 2^{n-1}}{2} \right\}$$



Calculating the Sum of a Sequence













Perform the following steps when you want to determine the sum of a specific range of the sequence of a recursion expression or a general term expression.

Example: To calculate the sum of the general term expression $a_n E = n^2 + 2n - 1$ in the range of $2 \leq n \leq 10$

• ClassPad Operation

(1) Start up the Sequence Editor.

- If you have another application running, tap  and then .
- If you have the Sequence application running, tap  and then [Sequence Editor].

(2) Tap (or press) , [Sequence RUN], [Calc], [Σ], [n, a_n], [n], , , , , , , [n, a_n], [n], , , , , [n, a_n], [n], , .

(3) Press .

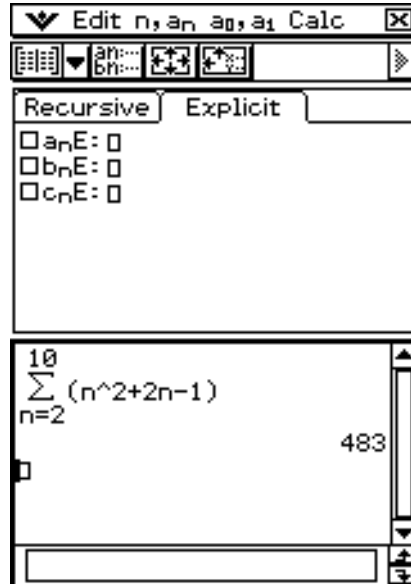

Tip

- For information about the syntax of the “ Σ ” function, see “2-8 Using the Action Menu”.

6-4 Using LinkTrace

While the Table and Graph windows are on the display, you can activate LinkTrace. To do this, tap in the Table window to make it active. Next, tap \blacklozenge and then [Link]. While LinkTrace is active, the pointer on the Graph window jumps automatically to the point indicated by the coordinates in the currently selected table cell. Note that LinkTrace does not work when the selected cell is in the first column (column n).

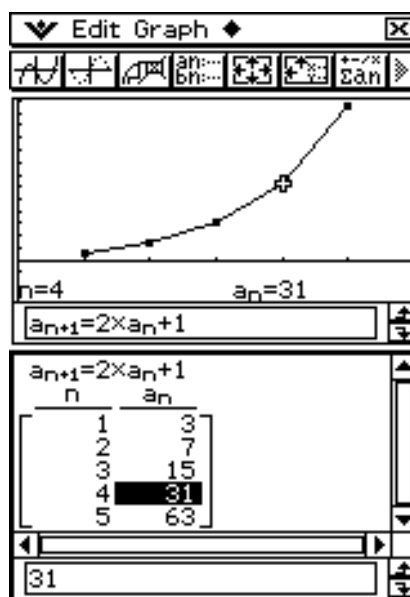
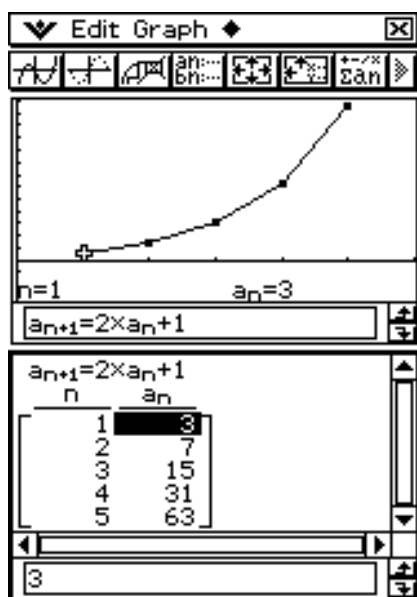



6-5 Drawing a Cobweb Diagram

You can use the procedure described here to input a sequence and draw a cobweb diagram.

Example: To graph $a_{n+1} = \frac{a_n^2}{2} - 1$, $a_1 = 0.5$

• ClassPad Operation

(1) Start up the Sequence Editor.

- If you have another application running, tap  and then .
- If you have the Sequence application running, tap  and then [Sequence Editor].

(2) Tap the [Recursive] tab.

(3) Specify the recursion type by tapping [Type] and then [a_{n+1} Type a_1].

(4) Input the recursion expression.

- Tap the input box to the right of a_{n+1} :, and then use the procedures under “6-2 Inputting an Expression in the Sequence Application” to input the following.

$[n, a_n] [a_n] \wedge 2 \div 2 - 1 \text{ EXE}$

(5) Input the initial value.

$0 . 5 \text{ EXE}$

(6) Tap  and then [View Window].

- This displays a dialog box for configuring View Window settings.

(7) Configure View Window settings as shown below.

xmin = -2 xmax = 3 xscale = 1 xdot: (Specify auto setting.)

ymin = -1 ymax = 1 yscale = 1 ydot: (Specify auto setting.)

(8) After everything is the way you want, tap [OK].

(9) Tap .

(10) Press EXE for each step of the web.

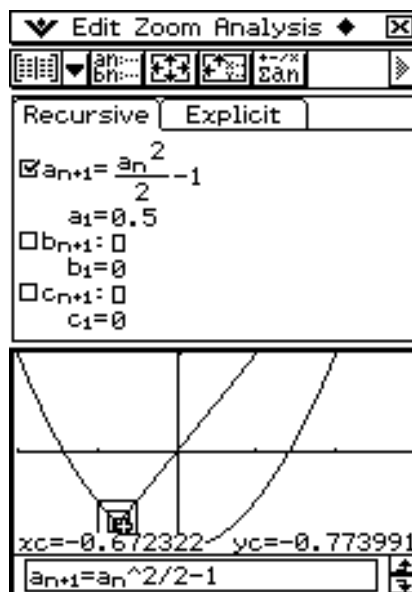

Tip

- On the cobweb graph window, you can draw the cobweb diagram again by selecting Trace on the Analysis menu.

Chapter

7

Using the Statistics Application

7

This chapter explains how to use the Statistics application. You can use the Statistics application to perform a variety of statistical calculations and to graph statistical data. Numeric data stored in lists can be used to perform Statistics application operations.

This chapter also includes information about performing statistical tests, and calculating confidence intervals and distributions. Note that such statistical calculations can be performed using statistical commands to create programs using the Program application.

- 7-1 Statistics Application Overview**
- 7-2 Using Stat Editor**
- 7-3 Before Trying to Draw a Statistical Graph**
- 7-4 Graphing Single-Variable Statistical Data**
- 7-5 Graphing Paired-Variable Statistical Data**
- 7-6 Using the Statistical Graph Window Toolbar**
- 7-7 Performing Statistical Calculations**
- 7-8 Test, Confidence Interval, and Distribution Calculations**
- 7-9 Tests**
- 7-10 Confidence Intervals**
- 7-11 Distributions**
- 7-12 Statistical System Variables**

7-1 Statistics Application Overview

This section describes the configuration of the Statistics application windows and provides basic information about its menus and commands.

The Statistics application provides you with the tools you need to perform the operations listed below.

You can also use the Program application (page 12-7-4) to perform statistical operations.

- **List data input and sorting**

- **Statistical graph drawing**

- Single-variable statistical graphs (Normal Probability Plot, Histogram, Med-Box plot, Normal Distribution curve, Broken line graph)
- Paired-variable statistical graphs (Scatter diagram, xy line graph, various types of regression graphs)

- **Statistical calculation**

- Single-variable statistical calculations
- Paired-variable statistical calculations
- Regression calculations
- Residual calculations
- Test, Confidence Interval and Distribution calculations (in Statistics and Program applications)



Starting Up the Statistics Application

Use the following procedure to start up the Statistics application.

• ClassPad Operation

On the application menu, tap  Statistics.

This starts the Statistics application and displays the Stat Editor window.

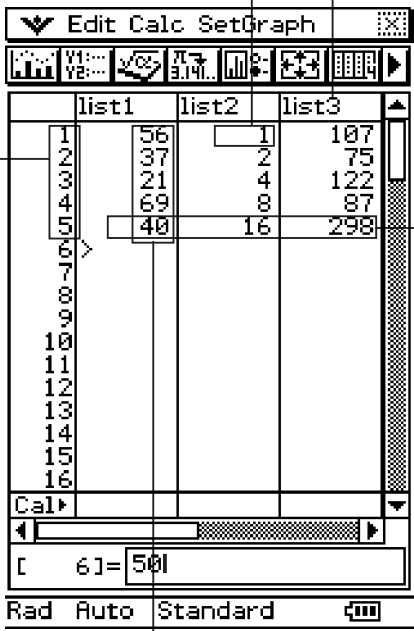

Line number

List name cell
Cell (variable name)

	list1	list2	list3
1			
2	56	1	107
3	37	2	75
4	21	4	122
5	69	8	87
6	40	16	298
7			
8			
9			
10			
11			
12			
13			
14			
15			
16			

Line

















Column

Rad Auto Standard

61 = 50

Stat Editor Window Menus and Buttons

This section explains the operations you can perform using the menus and buttons of the Statistical application's Stat Editor window.

To do this:	Tap this button:	Or select this menu item:
Open an existing list (page 7-2-3)	—	Edit - Open List
Close the currently selected list (page 7-2-4)	—	Edit - Close List
Jump to line 1 of the current list (page 7-2-3)	—	Edit - Jump to Top
Jump to the line after the last line of the current list (page 7-2-3)	—	Edit - Jump to Bottom
Sort list data ascending (page 7-2-8)		Edit - Sort(Ascending)
Sort list data descending (page 7-2-8)		Edit - Sort(Descending)
Delete a cell (page 7-2-7)		Edit - Delete - Cell
Delete all of the data in a list (page 7-2-7)		Edit - Delete - Column
Delete a list from memory (page 7-2-7)	—	Edit - Delete - List Variable
Insert a cell into a list (page 7-2-7)		Edit - Insert Cell
Draw a statistical graph		—
Display Graph Editor window		—
Display the Main application work area window		—
Convert a mathematical expression to a value		—
Display the Set StatGraphs dialog box		SetGraph - Setting...
Display the View Window dialog box		 - View Window
Display the Variable Manager	—	 - Variable Manager
Display two columns in the Stat Editor window		—
Display three columns in the Stat Editor window		—
Display four columns in the Stat Editor window		—

Note

- See page 2-1-3 for information about [Edit] menu commands “Cut” through “Clear All”.
- The [Calc] menu contains a selection statistical analysis tools that are described in the following sections of this chapter.

Stat Editor Window Status Bar

The status bar at the bottom of the Stat Editor window shows the current angle unit setting (page 1-9-5), statistics View Window setting (page 7-3-2), and decimal calculation setting (page 1-9-5).

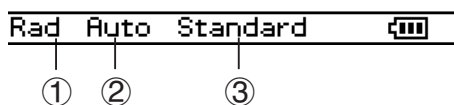

	If you see this:	It means this:
①	Rad	The angle unit setting is radians.
	Deg	The angle unit setting is degrees.
	Gra	The angle unit setting is grads.
②	Auto	Statistics View Window settings are configured automatically.
	<blank>	Statistics View Window settings need to be configured manually.
③	Standard	Standard mode: Displays result in exact form (fractional format).
	Decimal	Decimal mode: Converts result to a decimal (approximate value).

Tip

- The ① and ③ settings can be changed by tapping the status bar.
- The ② setting can be changed only on the [Special] tab of the Graph Format dialog box under ^{Settings}  (see page 1-9-6).



7-2 Using Stat Editor

Lists play a very important role in ClassPad statistical calculations. This section provides an overview of list operations and terminology. It also explains how to use the Stat Editor, a tool for creating and maintaining lists.

Basic List Operations

This section provides the basics of list operations, including how to start up the Statistics application, how to open a list, and how to close a list. It also tells you about list variables and how to use them.

■ What is a list?

A list is a type of data array that makes it possible to manipulate multiple data items as a group. A list has one column and can contain up to 9,999 rows. You can display up to 99 lists on the Stat Editor window.

List operations are performed using the Stat Editor window, which appears whenever you start up the Statistics application.

Lists are treated as variables, and like variables, are stored in a folder in the memory and can be manipulated using the Variable Manager. If a list is cleared from the display, it still exists in memory as a variable and can be recalled when needed.

Note

- See “Inputting Data into a List” for information about data input (page 7-2-4).

■ Using List Variables

The list name is located in the cell at the top of each list. List variable names can be used inside of calculation formulas, just like any other variable name. The initial default Stat Editor window shows six lists (columns), named list1 through list6.



■ Creating a List

A list starts out with an initial default name like list1, list2, list3, etc. The Stat Editor allows you to generate list data (list variables) quickly and easily.

Note

- The Stat Editor window has six default list variables, named “list1” through “list6”. These lists are system variables that are defined by the system. For more information about system variables, see “Variable Types” on page 1-7-2.
- The list name can be changed from its default name, “list1” through “list6”, to a name that you specify.

● To create a list

- (1) On the Stat Editor window, tap the list name cell at the top of the list you want to name. This selects the list name cell.
- (2) Enter up to eight bytes for the list name you want, and then press **EXE**.
 - You cannot use any ClassPad reserved words as list variable names. You also cannot specify a list name that is already used by another list.

Tip

- If you enter a list name that is already used for another list, tapping **EXE** displays the contents of that list. The data of the existing list replaces data you have input on the Stat Editor window.
- Entering a list name without specifying a folder stores the variable name in the current folder. To store the variable name in another folder, specify the folder name along with the list name. To store the variable name of a list named “a” in a folder named “abc”, for example, enter the following for the list name: abc\a. For information about creating a variable, see “Creating a New Variable” on page 1-7-6.

■ Navigating Around the Stat Editor Window

The following describes the different techniques you can use to navigate around the Stat Editor window and select the cell you want.

● To select a cell

Use the cursor key to move the highlighting up, down, left, and right. The Stat Editor window scrolls automatically whenever the highlighting reaches a cell at the edge of the window. You can also select a particular cell by tapping it with the stylus.



● **To jump to the first or last line of a list**

- (1) Select any cell in the list.
- (2) On the menu bar, tap [Edit].
- (3) Select one of the following commands to perform the type of operation you want.

To do this:	Select this command:
Move the cursor to line 1 of the list	Jump to Top
Move the cursor to the line following the last line that contains data <ul style="list-style-type: none"> • If your list contains 14 entries, then the cursor will move to the 15 entry. • If your list contains 9999 entries (the maximum allowed), then the cursor will move to line 9999. 	Jump to Bottom

■ **Opening a List**

Lists are saved in files under their list (variable) names. This means you can close a list and re-open it later when you need it.

There are two different methods you can use to open a list: using the [Open List] command and inputting the name of the list in the list name cell of a column.

● **To open an existing list using the “Open List” command**

- (1) On the Stat Editor window, select any cell in the column where you want the list you will open to appear.
- (2) On the menu bar, tap [Edit] and then [Open List].
- (3) In the “list=” box that appears, enter the variable name of the list you want to open, and then tap **EXE**.

Tip

- If you enter a variable name that does not match the names of any of the existing lists in step (3), a new list is created using that name.

● **To open an existing list by inputting its name in the list name cell**

- (1) On the Stat Editor window, select the list name cell of the column where you want the list you will open to appear.
- (2) Enter the variable name of the list you want to open.
- (3) Tap **EXE** to open the list.



■ Closing a List

Closing a list saves it under its current list (variable) name.

There are two different methods you can use to close a list: using the [Close List] command, and clearing the list name from its list name cell.

● To close a list using the “Close List” command

- (1) On the Stat Editor window, select any cell of the list you want to close.
- (2) On the menu bar, tap [Edit] and then [Close List].
 - The selected list disappears from the display and is replaced by all blanks.
 - At this time, the “list=” box also appears. To open another list, enter its name into the “list=” box, and then tap **EXE**.

Tip

- This above operation clears the list from the display only. The list is still stored as a list variable in memory, and can be opened when you need it again.

● To close a list by clearing its list name

- (1) On the Stat Editor window, select the list name cell of the column of the list you want to close.
- (2) Tap the “list=” box at the bottom of the Stat Editor window.
- (3) Press the **clear** key so the list (variable) name is cleared.
- (4) Tap **EXE**.

Inputting Data into a List

Use the procedures in this section to input data and expressions into a list.

● To input a single data item

- (1) On the Stat Editor window, select the cell where you want to input the data item.
 - Use the cursor key to move the highlighting, or tap the cell with the stylus.

	list1	list2	list3
1	130	33333	
2	171	"abcd"	
3	159	Undef..	
4	144	999	
5	66	>	

Cal▶

← 5]=26

Line number where data is being input



Input data

Cell where data is being input

String input

(2) Input the data you want.



To input a value

- Use the input keypad or soft keyboard that appears when you press . You can also access the soft keyboard by tapping  Menu.

To input a mathematical expression

- Use the soft keyboard that appears when you press .
- When the “Decimal Calculation” check box is not selected (unchecked) on the Basic Format dialog box (page 1-9-4), any mathematical expression you input is stored as-is.
- When the “Decimal Calculation” check box is selected, the mathematical expression is converted to a value before it is stored. Input of 1/2, for example, is converted to 0.5.

To input a string

- Enclose text in quotation marks to make it a string. To input quotation marks, press  to display the soft keyboard, tap the  tab, and then tap . For more information about strings, see page 12-6-41.



(3) Press  to store the data in the cell.

- Selecting a cell that already contains data replaces the existing data with the new data.

Tip

- You can also input a variable name as list data. In this case, pressing  in step (3) causes either of the following to happen.

Inputting this type of variable:	Causes this to appear in the cell:
Defined variable	Variable contents (right aligned for value or left aligned for expression)
Undefined variable	Variable name

- You need to assign a name to a list before you can input data. Trying to input data into an unnamed list will cause the cursor to jump automatically to the list name cell at the top of that list. For information on how to name lists, see “Creating a List” on page 7-2-2.
- To convert an expression in a cell to a value, select the cell and then tap .
- Note that statistical calculations and graphing can be performed only using a list that contains numeric values or mathematical expressions that can be converted into numeric values. An error occurs if you try to perform a statistical calculation or draw a graph using a list that contains a string or a non-convertible mathematical expression.
- You cannot edit list data while the  icon is displayed in the “Cal” line.



• **To batch input a set of data**

Example: To input the values 1, 2, and 3 into list1

- (1) On the Stat Editor window, select the “Cal” cell of the list where you want to input the data (list1 in this example).
- (2) Enter {1,2,3}.
 - To input braces ({}), press **Keyboard** to display the soft keyboard, and then tap the **mth** tab.
- (3) Tap **EXE**.

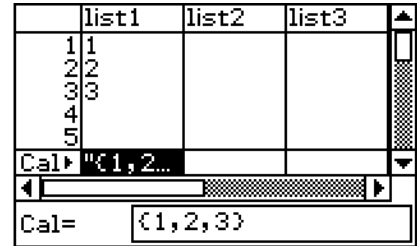

Tip

- Separate values by commas. Do not input a comma following the last value.
 Incorrect: {34,53,78,}
 Correct: {34,53,78}

• **To input calculation results into a cell**

Example: To multiply the value of each cell in list1 by two and input the results in list2

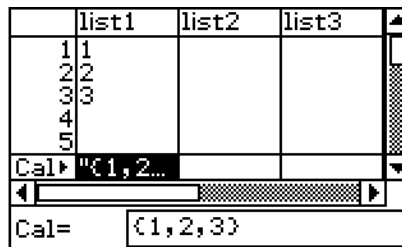

- (1) On the Stat Editor window, select the “Cal” cell of the list where you want to input the calculation results (list2 in this example).
- (2) In the “Cal=” box, enter the calculation formula (list1×2 in this example).
- (3) Press **EXE** to perform the calculation. The values in each cell of list1 are doubled, and the results are input into list2.

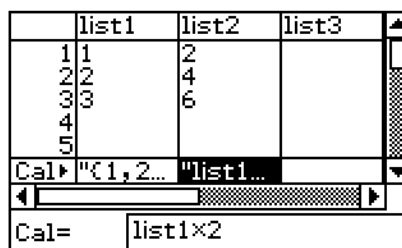

Editing List Contents

Use the procedures in this section to delete and insert elements, to clear data, and to sort data.

• To delete a list cell

- (1) On the Stat Editor window, select the cell you want to delete.
- (2) Tap [Edit].
- (3) On the menu that appears, tap [Delete], and then tap [Cell] on the submenu that appears.
 - This deletes the cell and shifts all of the cells below it upwards.

Tip

- You can also delete a cell by selecting it and then pressing the  key.
- Note that deleting a cell does not affect the cells in other lists. If the position of the cell you are deleting or the cells underneath it are aligned with certain cells of another list, deleting the cell will cause misalignment of the cells underneath it when they shift upwards.

• To delete all of the data in a list

- (1) On the Stat Editor window, select the list whose data you want to delete.
- (2) Tap [Edit].
- (3) On the menu that appears, tap [Delete]. On the submenu that appears, tap [Column].
- (4) On the confirmation dialog box that appears, tap [OK] to delete the list data, or [Cancel] to cancel the delete operation.
 - Tapping [OK] deletes all the data from the list, and leaves the empty list in memory.

• To delete a list from memory

- (1) On the Stat Editor window, select the list you want to delete.
- (2) Tap [Edit].
- (3) On the menu that appears, tap [Delete]. On the submenu that appears, tap [List Variable].
- (4) On the confirmation dialog box that appears, tap [OK] to delete the list, or [Cancel] to cancel the delete operation.
 - Tapping [OK] deletes the list from memory.

• To insert a cell into a list

- (1) On the Stat Editor window, select the list cell where you want to insert a new cell.
- (2) On the menu bar, tap [Edit] and then [Insert Cell].
 - This inserts a cell at the current highlighted location, shifting all the cells below it downwards. The new cell contains the word “Undefined”.



Tip

- Note that inserting a cell does not affect the cells in other lists. If you insert a cell in a list that is aligned with another list, the lists will become misaligned when the cells underneath are shifted downwards.

Sorting List Data

You can use the procedures in this section to sort the data of a list in ascending or descending order. Note that the location of the highlighting does not have any affect on a sort operation.

• To sort a single list

- (1) On the Stat Editor window, tap [Edit] and then [Sort(Ascending)] or [Sort(Descending)].
- (2) In response to the “How Many Lists?” prompt that appears, select 1 and then tap [OK].
- (3) In response to the “Select List Name” prompt that appears, tap the down arrow button and then select the name (variable name) of the list you want to sort.
- (4) Tap [OK] to sort the data.

• To sort multiple lists on a base list



- (1) On the Stat Editor window, tap [Edit] and then [Sort(Ascending)] or [Sort(Descending)].
- (2) In response to the “How Many Lists?” prompt that appears, tap the down arrow button and then specify the number of lists you want to sort.
- (3) Tap [OK].
- (4) In response to the “Select Base List” prompt that appears, tap the down arrow button and then select the name (variable name) of the list on which you want the sort to be based.
- (5) Tap [OK].
- (6) In response to the “Select Second List” prompt that appears, tap the down arrow button and then select the name (variable name) of the second list to be sorted.
- (7) Tap [OK].
- (8) Repeat steps (6) and (7) as many times as necessary to specify all of the lists to be sorted.
 - Tapping [OK] after selecting the final list executes the actual sort operation.



Controlling the Number of Displayed List Columns

You can use the following procedures to control how many list columns appear on the Statistics application window. You can select 2, 3, or 4 columns.

- **To specify the number of columns for the list display**

On the Stat Editor window, tap  (two columns),  (three columns) or  (four columns) to specify the width. You will need to tap the arrow button on the right end of the toolbar to see the icons.

Tip

- You can also specify the number of display cells using the [Cell Width Pattern] setting on the [Special] tab of the Graph Format dialog box (page 1-9-6).
- When you have the Stat Editor window displayed along with a second window, you can make the Stat Editor window active and then tap the  button on the icon panel to expand the Stat Editor window to fill the entire display. For more information, see “Using a Dual Window Display” on page 1-5-1.

Clearing All Stat Editor Data

Use the following procedure to initialize the Stat Editor and clear all currently displayed data. Following this procedure, the Stat Editor shows six empty lists, named list1 through list6.

Warning!

- Performing the following procedure clears all the data from Stat Editor window list1 through list6 and any additional lists currently in memory.

- **To clear all stat editor data**

- (1) On the Stat Editor window, tap [Edit] and then [Clear All].
- (2) On the confirmation dialog box that appears, tap [OK] to clear the all list data or [Cancel] to cancel the clear operation.
 - After you tap [OK], the Stat Editor window shows six empty lists (three lists visible on the ClassPad display at a time), named list1 through list6.



7-3 Before Trying to Draw a Statistical Graph

Before drawing a statistical graph, you need to first configure its “StatGraph setup” using the [SetGraph] menu.

The StatGraph setup allows you to configure parameters to control the graph type, the lists that contain a graph’s data, the type of plot markers to be used, and other settings. Up to nine StatGraph setups, named StatGraph1, StatGraph2, and so on, can be stored in memory for later recall.

Using the SetGraph Menu

Tapping [SetGraph] on the Stat Editor window menu bar displays a menu like the one shown below.

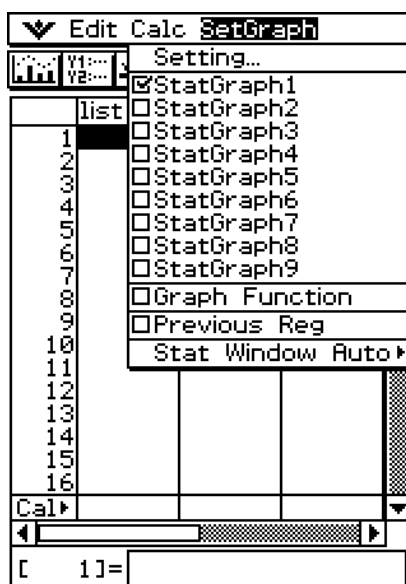

The following describes what you can do with each of the [SetGraph] menu items. See the following pages for details about performing each type of operation.

When you want to do this:	Do this:
Display a dialog box for specifying the graph type and data list for each StatGraph setup	Tap [Setting...].
Select a StatGraph setup for graphing	Select the check box next to the StatGraph setup you want to graph. This can also be achieved by tapping [Setting...] and scrolling through StatGraph1 through StatGraph9.
Overlay a function graph on a statistical graph	Select the check box next to [Graph Function].
Turn off function graph overlay	Clear the check box next to [Graph Function].
Graph the results of the last regression calculation you performed	Select the check box next to [Previous Reg].

When you want to do this:	Do this:
Turn off graphing of the last regression calculation results	Clear the check box next to [Previous Reg].
Have Statistics View Window settings configured automatically	Tap [Stat Window Auto] and then select [On].
Configure Statistics View Window settings manually	Tap [Stat Window Auto] and then select [Off].

Configuring StatGraph Setups

Use the procedure below to display the Set StatGraphs dialog box and configure the nine StatGraph setups.

• To display the Set StatGraphs dialog box

(1) On the Stat Editor window, tap [SetGraph] and then [Setting...].

- This displays the Set StatGraphs dialog box.

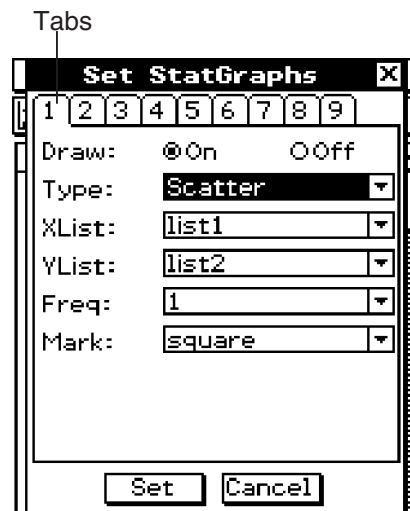

- There are tabs named 1 through 9, correspond to StatGraph1 through StatGraph9.
- (2) Tap the tab for the StatGraph setup whose configuration you want to change.
- (3) Configure the StatGraph setup settings you want as described below, and then tap [Set]. This will apply the settings for all nine StatGraphs.
- To exit the Set StatGraphs dialog box without changing any settings, tap [Cancel] instead of [Set].

- **Draw**

To do this:	Select this option:
Draw the graph using the StatGraph setup of the current tab	On
Not draw the graph using the StatGraph setup of the current tab	Off

- **Type**

Tap the down arrow button, and then select the graph type from the list that appears.

To draw this type of graph:	Select this option:
Scatter plot	Scatter
xy line graph	xy Line
Normal probability plot	NPPlot
Histogram	Histogram
Med-box plot	MedBox
Normal distribution curve	NDist
Broken line graph	Broken
Linear regression graph	LinearR
Med-Med graph	MedMed
Quadratic regression graph	QuadR
Cubic regression graph	CubicR
Quartic regression graph	QuartR
Logarithmic regression graph	LogR
Exponential regression graph ($y = a \cdot e^{b \cdot x}$)	ExpR
Exponential regression graph ($y = a \cdot b^x$)	abExpR
Power regression graph	PowerR
Sinusoidal regression graph	SinR
Logistic regression graph	LogisticR

- **XList**

Tap the down arrow button, and then select the name of the list (list1 through list6, or a list name you assigned) that you want to use for x -axis data.

- You need to specify only an XList in the case of single-variable statistics (page 7-4-1). The initial default [XList] setting is “list1”.

- **YList**

Tap the down arrow button, and then select the name of the list (list1 through list6, or a list name you assigned) that you want to use for y -axis data.

- Specify a YList in addition to an XList in the case of paired-variable statistics (page 7-5-1). The initial default [YList] setting is “list2”.



- **Freq**

Tap the down arrow button, and then select the frequency setting from the list that appears.

To do this:	Select this option:
Plot each data value once	1
Specify a list whose values indicate the frequency of each data value	list1 — list6 (or a list name you assigned)

- The initial default frequency setting is 1. Specifying a list that causes each data value to be plotted five times helps to improve the appearance of scatter plots.
- A list of frequency values can contain non-zero integers and decimal values. In the case of a MedBox, or MedMed graph, however, a frequency list can contain positive integers only. Non-integer values (such as those with a decimal part) cause an error during statistical calculations.

- **Mark**

Tap the down arrow button, and select the shape you want to use for the plot points of a scatter diagram (Scatter), xy line graph (xy Line), or normal probability plot (NPPlot).

Mark Name	Mark
square	□
cross	×
ldot	▪
dot	·

Tip

- The default graph setting for all nine StatGraph setups is a scatter plot (Scatter).



7-4 Graphing Single-Variable Statistical Data

Single-variable data is data that consists of a single value. If you are trying to obtain the average height of the members of a single class, for example, the single variable would be height.

Single-variable statistics include distributions and sums. You can produce any of the graphs described below using single-variable data.

Before trying to draw any of the graphs described below, configure the graph setup using the procedures under “Configuring StatGraph Setups” on page 7-3-2.

Normal Probability Plot (NPPlot)

The normal probability plot plots data against a theoretical normal distribution using a scatter plot. If the scatter plot is close to a straight line, then the data is approximately normal. A departure from the straight line indicates a departure from normality.

■ Graph Parameter Settings (page 7-3-3, 7-3-4)

- [XList] specifies the list that contains the data to be plotted.
- [Mark] specifies the shape of the plot mark.

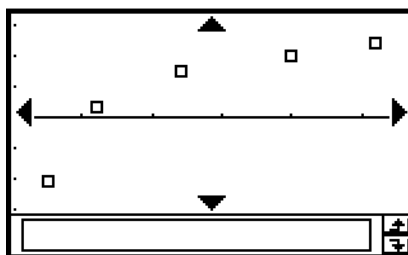

Histogram Bar Graph (Histogram)

A histogram shows the frequency (frequency distribution) of each data class as a rectangular bar. Classes are on the horizontal axis, while frequency is on the vertical axis.

■ Graph Parameter Settings (page 7-3-3, 7-3-4)

- [XList] specifies the list that contains the data to be graphed.
- [Freq] specifies the frequency of the data.

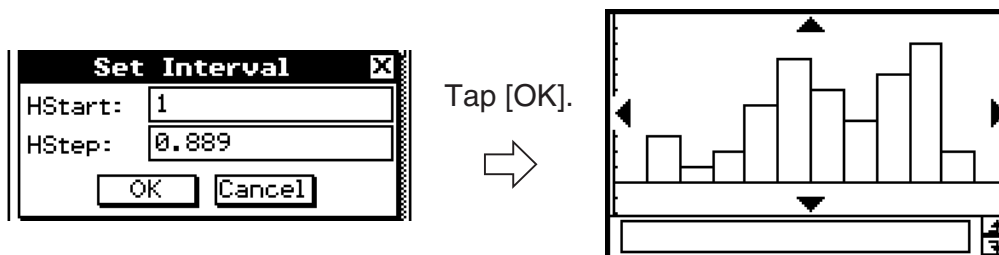

A dialog box like the one shown above appears before the graph is drawn. You can use this dialog box to change the start value (HStart) and step value (HStep) of the histogram, if you want.

The initial HStart and HStep values on the Set Interval dialog box are set in accordance with the Stat Window Auto setting. When On is selected for Stat Window Auto, appropriate values for the graph data are input automatically. When Off is selected, the values that were displayed the last time the Set Interval dialog box was displayed are input automatically.

Med-Box Plot (MedBox)

This type of graph is often called a “Box and Whisker” graph. It lets you see how a large number of data items are grouped within specific ranges.

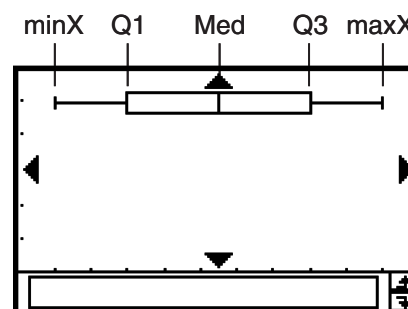

Label	Meaning	Description
minX	minimum	The data's smallest value
Q1	First Quartile	The median between minX and Med
Med	Median	The median of all the data values. If you have 13 values, for example, this is the value at position seven (six values left and right).
Q3	Third Quartile	The median between maxX and Med
maxX	maximum	The data's largest value

- The lines from minX to Q1, and from Q3 to maxX are called “whiskers”.

■ Graph Parameter Settings (page 7-3-3, 7-3-4)

- [XList] specifies the list that contains the data to be plotted.
- [Freq] specifies the frequency of the data.
- If [Show Outliers] box is checked, “outlier” square symbols are shown instead of “whisker” lines where a data value is relatively large or small compared to the other data values.

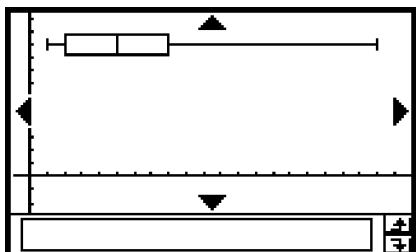

Figure. Do not show Outliers

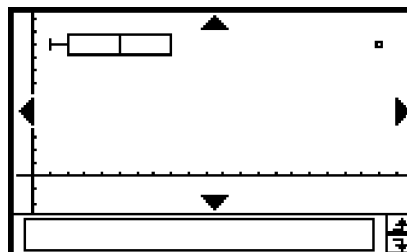

Figure. Show Outliers

Tip

- When specifying a list of frequency values, make sure that the list contains positive integers only. Non-integer values (such as those with a decimal part) cause an error during statistical calculations.

Normal Distribution Curve (NDist)

The normal distribution curve is graphed using the following normal distribution function.

$$y = \frac{1}{\sqrt{2\pi}\sigma_n} e^{-\frac{(x-\bar{x})^2}{2\sigma_n^2}}$$

■ Graph Parameter Settings (page 7-3-3, 7-3-4)

- [XList] specifies the list that contains the data to be graphed.
- [Freq] specifies the frequency of the data.

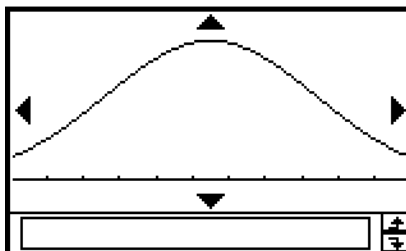

Broken Line Graph (Broken)

In the broken line graph, lines connect the pointers that fall at the center of each histogram bar.

■ Graph Parameter Settings (page 7-3-3, 7-3-4)

- [XList] specifies the list that contains the data to be graphed.
- [Freq] specifies the frequency of the data.

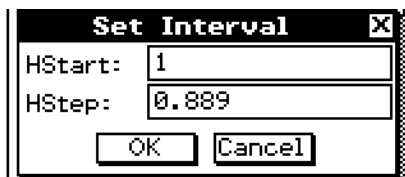

Tap [OK].

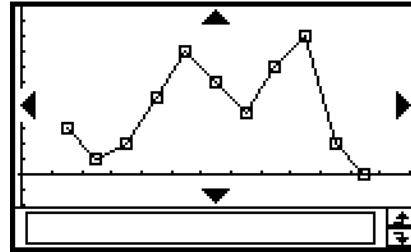

A dialog box like the one shown above appears before the graph is drawn. You can use this dialog box to change the start value (HStart) and step value (HStep) of the histogram, if you want.



7-5 Graphing Paired-Variable Statistical Data

With paired-variable statistical data there are two values for each data item. An example of paired-variable statistical data would be the change in size of an iron bar as its temperature changes. One variable would be temperature, and the other variable is the corresponding bar size. Your ClassPad lets you produce any of the graphs described in this section using paired-variable data.

Before trying to draw any of the graphs described below, configure the graph setup using the procedures under “Configuring StatGraph Setups” on page 7-3-2.

Drawing a Scatter Plot and xy Line Graph

Use the procedure below to plot a scatter diagram and then connect the dots to produce an xy line graph.

Example: Input the paired-variable data shown below. Next, plot the data on a scatter diagram and then connect the dots to produce an xy line graph.

list1 = 0.5, 1.2, 2.4, 4.0, 5.2

list2 = -2.1, 0.3, 1.5, 2.0, 2.4

• ClassPad Operation

(1)   Statistics

(2) Input the data shown above.

(3) Tap [SetGraph] and then [Setting...], or tap .

(4) On the Set StatGraphs dialog box that appears, configure a StatGraph setup with the scatter plot settings shown below, and then tap [Set].

Draw: On

Type: Scatter

XList: list1

YList: list2

(5) Tap  to plot the scatter plot.

(6) Tap the List window to make it active.

(7) Tap [SetGraph] and then [Setting...], or tap .

(8) On the Set StatGraphs dialog box that appears, configure a StatGraph setup with the xy line graph settings shown below, and then tap [Set].

Draw: On

Type: xy Line

XList: list1

YList: list2



(9) Tap  to draw the xy line graph.

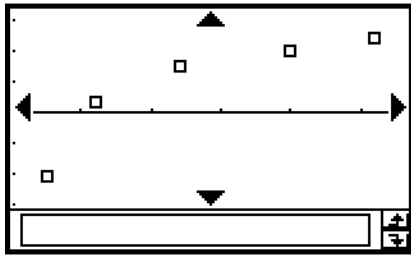

Scatter diagram

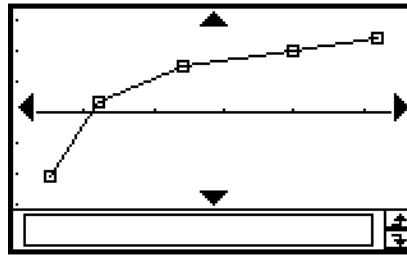
 xy line graph

Drawing a Regression Graph

Use the procedures below to input paired-variable statistical data. Next perform regression using the data and then graph the results. Note that you can draw a regression graph without performing the regression calculation.

Example 1: Input the paired-variable data shown below and plot the data on a scatter diagram. Next, perform logarithmic regression on the data to display the regression parameters, and then draw the regression graph.

list1 = 0.5, 1.2, 2.4, 4.0, 5.2

list2 = -2.1, 0.3, 1.5, 2.0, 2.4

• ClassPad Operation

(1)  

(2) Input the data shown above.

(3) Tap [SetGraph] and then [Setting...], or tap .

(4) On the Set StatGraphs dialog box that appears, configure a StatGraph setup with the settings shown below, and then tap [Set].

Draw: On

Type: Scatter

XList: list1

YList: list2

(5) Tap  to plot the scatter diagram.

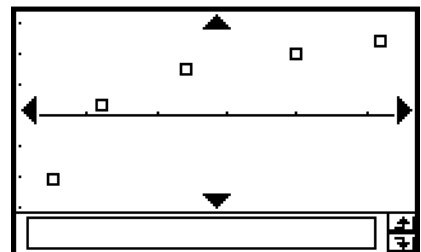

(6) Tap [Calc] [Logarithmic Reg].

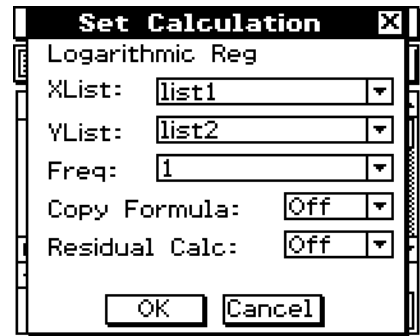

Set Calculation [X]

Logarithmic Reg

XList: list1 [v]

YList: list2 [v]

Freq: 1 [v]

Copy Formula: Off [v]

Residual Calc: Off [v]

[OK] [Cancel]

(7) Tap [OK].

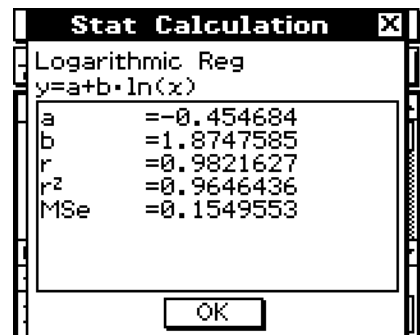

Stat Calculation [X]

Logarithmic Reg

$y = a + b \cdot \ln(x)$

a	=-0.454684
b	=1.8747585
r	=0.9821627
r ²	=0.9646436
MSe	=0.1549553

[OK]

(8) Tap [OK] .

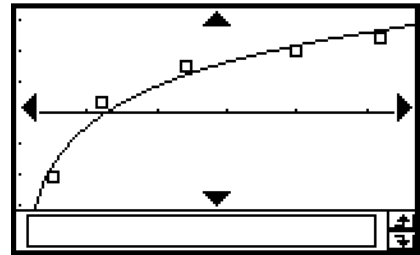

Tip

- You can perform trace (page 3-7-1) on a regression graph. Trace scroll, however, is not supported when a scatter diagram is displayed.

Example 2: Input the paired-variable data shown below (which is the same data as Example 1), and then draw the regression graph without performing regression calculation.

list1 = 0.5, 1.2, 2.4, 4.0, 5.2

list2 = -2.1, 0.3, 1.5, 2.0, 2.4

• ClassPad Operation

(1)   Statistics

(2) Input the data shown above.

(3) Tap [SetGraph] and then [Setting...], or tap .

(4) On the Set StatGraphs dialog box that appears, configure a StatGraph setup with the settings shown below, and then tap [Set].

Draw: On

Type: LogR

XList: list1

YList: list2

(5) Tap  to graph.

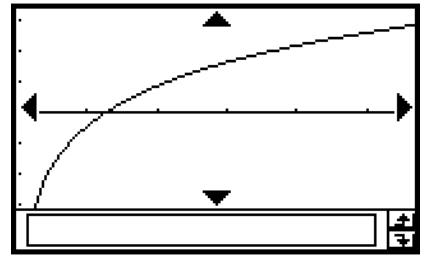

Graphing Previously Calculated Regression Results

Performing the following procedure graphs the last set of regression results you calculated. Use this procedure when you want to perform statistical calculations without graphing first, and then graph the results.

• ClassPad Operation

(1) [SetGraph]

(2) On the menu that appears, select the [Previous Reg] check box.

(3) Tap the Graph window or  to graph the last set of regression results you calculated.

Tip

- Calculated regression results are stored in memory whenever you perform a regression calculation from the Stat Editor menu or from the Statistical Graph [Calc] menu.
- The [Previous Reg] check box described in step (2) above is selected automatically whenever you perform a regression calculation from the Stat Editor menu or from the Statistical Graph [Calc] menu.

Drawing a Linear Regression Graph

Linear regression uses the method of least squares to determine the equation that best fits your data points, and returns values for the slope and y-intercept. The graphic representation of this relationship is a linear regression graph.

• ClassPad Operation

Start the graphing operation from the Statistics application's Graph window or List window.

From the Graph window

Tap [Calc] [Linear Reg] [OK] [OK] .

From the List window

Tap [SetGraph] [Setting...], or .

On the Set StatGraphs dialog box that appears, configure a StatGraph setup with the setting shown below, and then tap [Set].

Type: LinearR

Tap  to draw the graph.

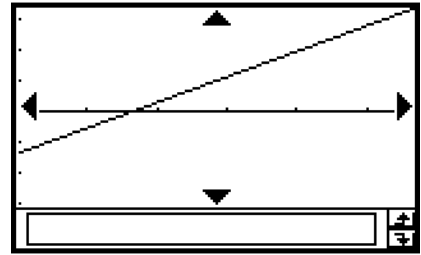

The following is the linear regression model formula.

$$y = a \cdot x + b$$

a : regression coefficient (slope)

b : regression constant term (y-intercept)

r : correlation coefficient

r^2 : coefficient of determination

MSe : mean square error

$$\bullet MSe = \frac{1}{n-2} \sum_{i=1}^n (y_i - (a \cdot x_i + b))^2$$

Drawing a Med-Med Graph

When you suspect that the data contains extreme values, you should use the Med-Med graph (which is based on medians) in place of the linear regression graph. Med-Med graph is similar to the linear regression graph, but it also minimizes the effects of extreme values.

• ClassPad Operation

Start the graphing operation from the Statistics application's Graph window or List window.

From the Graph window

Tap [Calc] [MedMed Line] [OK] [OK] .

From the List window

Tap [SetGraph][Setting...], or .

On the Set StatGraphs dialog box that appears, configure a StatGraph setup with the setting shown below, and then tap [Set].

Type: MedMed

Tap  to draw the graph.

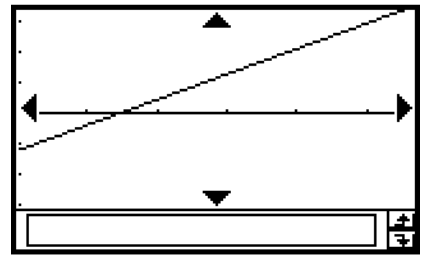

The following is the Med-Med model formula.

$$y = a \cdot x + b$$

a : Med-Med graph slope

b : Med-Med graph y -intercept

Tip

- When specifying a list of frequency values, make sure that the list contains positive integers only. Non-integer values (such as those with a decimal part) cause an error during statistical calculations.

Drawing Quadratic, Cubic, and Quartic Regression Graphs

You can draw a quadratic, cubic, or quartic regression graph based on the plotted points. These graphs use the method of least squares to draw a curve that passes the vicinity of as many data points as possible. These graphs can be expressed as quadratic, cubic, and quartic regression expressions.

The following procedure shows how to graph a quadratic regression only. Graphing the cubic and quartic regressions are similar.

• ClassPad Operation (Quadratic Regression)

Start the graphing operation from the Statistics application's Graph window or List window.

From the Graph window

Tap [Calc] [Quadratic Reg] [OK] [OK] .

- For cubic regression tap [Cubic Reg] and for quartic regression tap [Quartic Reg] instead of [Quadratic Reg].

From the List window

Tap [SetGraph][Setting...], or .

On the Set StatGraphs dialog box that appears, configure a StatGraph setup with the setting shown below, and then tap [Set].

Type: QuadR

- For cubic regression select [CubicR] and for quartic regression tap [QuartR] instead of [QuadR].

Tap  to draw the graph.

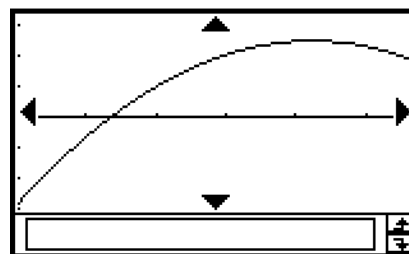

The following are the model formulas for each type of regression.

Quadratic Regression

Model Formula: $y = a \cdot x^2 + b \cdot x + c$

a : quadratic regression coefficient

b : linear regression coefficient

c : regression constant term (y-intercept)

r^2 : coefficient of determination

MSe : mean square error

$$\bullet MSe = \frac{1}{n-3} \sum_{i=1}^n (y_i - (a \cdot x_i^2 + b \cdot x_i + c))^2$$

Cubic Regression

Model Formula: $y = a \cdot x^3 + b \cdot x^2 + c \cdot x + d$

a : cubic regression coefficient

b : quadratic regression coefficient

c : linear regression coefficient

d : regression constant term (y-intercept)

r^2 : coefficient of determination

MSe : mean square error

$$\bullet MSe = \frac{1}{n-4} \sum_{i=1}^n (y_i - (a \cdot x_i^3 + b \cdot x_i^2 + c \cdot x_i + d))^2$$

Quartic Regression

Model Formula: $y = a \cdot x^4 + b \cdot x^3 + c \cdot x^2 + d \cdot x + e$

a : quartic regression coefficient

b : cubic regression coefficient

c : quadratic regression coefficient

d : linear regression coefficient

e : regression constant term (y-intercept)

r^2 : coefficient of determination

MSe : mean square error

$$\bullet MSe = \frac{1}{n-5} \sum_{i=1}^n (y_i - (a \cdot x_i^4 + b \cdot x_i^3 + c \cdot x_i^2 + d \cdot x_i + e))^2$$



Drawing a Logarithmic Regression Graph

Logarithmic regression expresses y as a logarithmic function of x . The normal logarithmic regression formula is $y = a + b \cdot \ln(x)$. If we say that $X = \ln(x)$, then this formula corresponds to the linear regression formula $y = a + b \cdot X$.

• ClassPad Operation

Start the graphing operation from the Statistics application's Graph window or List window.

From the Graph window

Tap [Calc] [Logarithmic Reg] [OK] [OK] .

From the List window

Tap [SetGraph][Setting...], or .

On the Set StatGraphs dialog box that appears, configure a StatGraph setup with the setting shown below, and then tap [Set].

Type: LogR

Tap  to draw the graph.

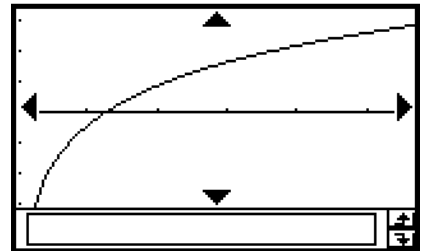

The following is the logarithmic regression model formula.

$$y = a + b \cdot \ln(x)$$

a : regression constant term

b : regression coefficient

r : correlation coefficient

r^2 : coefficient of determination

MSe : mean square error

$$\bullet MSe = \frac{1}{n-2} \sum_{i=1}^n (y_i - (a + b \cdot \ln(x_i)))^2$$

Drawing an Exponential Regression Graph ($y = a \cdot e^{b \cdot x}$)

Exponential regression can be used when y is proportional to the exponential function of x . The normal exponential regression formula is $y = a \cdot e^{b \cdot x}$. If we obtain the logarithms of both sides, we get $\ln(y) = \ln(a) + b \cdot x$. Next, if we say that $Y = \ln(y)$ and $A = \ln(a)$, the formula corresponds to the linear regression formula $Y = A + b \cdot x$.

• ClassPad Operation

Start the graphing operation from the Statistics application's Graph window or List window.

From the Graph window

Tap [Calc] [Exponential Reg] [OK] [OK] .

From the List window

Tap [SetGraph][Setting...], or .

On the Set StatGraphs dialog box that appears, configure a StatGraph setup with the setting shown below, and then tap [Set].

Type: ExpR

Tap  to draw the graph.

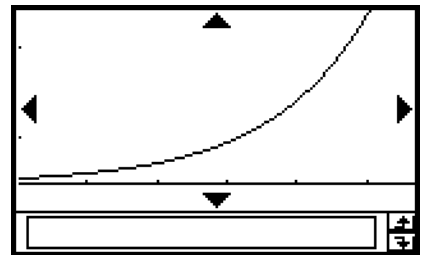

The following is the exponential regression model formula in this case.

$$y = a \cdot e^{b \cdot x}$$

a : regression coefficient

b : regression constant term

r : correlation coefficient

r^2 : coefficient of determination

MSe : mean square error

$$\bullet MSe = \frac{1}{n-2} \sum_{i=1}^n (\ln(y_i) - (\ln(a) + b \cdot x_i))^2$$

Drawing an Exponential Regression Graph ($y = a \cdot b^x$)

Exponential regression can be used when y is proportional to the exponential function of x . The normal exponential regression formula in this case is $y = a \cdot b^x$. If we take the natural logarithms of both sides, we get $\ln(y) = \ln(a) + (\ln(b)) \cdot x$. Next, if we say that $Y = \ln(y)$, $A = \ln(a)$ and $B = \ln(b)$, the formula corresponds to the linear regression formula $Y = A + B \cdot x$.

• ClassPad Operation

Start the graphing operation from the Statistics application's Graph window or List window.

From the Graph window

Tap [Calc] [abExponential Reg] [OK] [OK] .

From the List window

Tap [SetGraph][Setting...], or .

On the Set StatGraphs dialog box that appears, configure a StatGraph setup with the setting shown below, and then tap [Set].

Type: abExpR

Tap  to draw the graph.

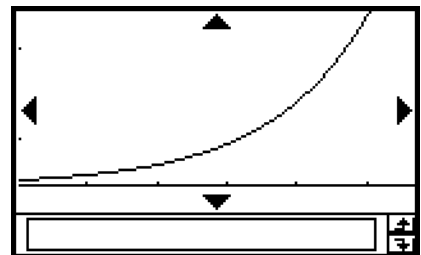

The following is the exponential regression model formula in this case.

$$y = a \cdot b^x$$

a : regression coefficient

b : regression constant term

r : correlation coefficient

r^2 : coefficient of determination

MSe : mean square error

$$\bullet MSe = \frac{1}{n-2} \sum_{i=1}^n (\ln(y_i) - (\ln(a) + (\ln(b)) \cdot x_i))^2$$

Drawing a Power Regression Graph ($y = a \cdot x^b$)

Power regression can be used when y is proportional to the power of x . The normal power regression formula is $y = a \cdot x^b$. If we obtain the logarithms of both sides, we get $\ln(y) = \ln(a) + b \cdot \ln(x)$. Next, if we say that $X = \ln(x)$, $Y = \ln(y)$, and $A = \ln(a)$, the formula corresponds to the linear regression formula $Y = A + b \cdot X$.

• ClassPad Operation

Start the graphing operation from the Statistics application's Graph window or List window.

From the Graph window

Tap [Calc] [Power Reg] [OK] [OK] .

From the List window

Tap [SetGraph][Setting...], or .

On the Set StatGraphs dialog box that appears, configure a StatGraph setup with the setting shown below, and then tap [Set].

Type: PowerR

Tap  to draw the graph.

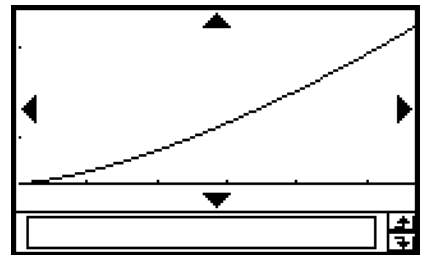

The following is the power regression model formula.

$$y = a \cdot x^b$$

a : regression coefficient

b : regression power

r : correlation coefficient

r^2 : coefficient of determination

MSe : mean square error

$$\bullet MSe = \frac{1}{n-2} \sum_{i=1}^n (\ln(y_i) - (\ln(a) + b \cdot \ln(x_i)))^2$$

Drawing a Sinusoidal Regression Graph ($y = a \cdot \sin(b \cdot x + c) + d$)

Sinusoidal regression is best for data that repeats at a regular fixed interval over time.

• ClassPad Operation

Start the graphing operation from the Statistics application's Graph window or List window.

From the Graph window

Tap [Calc] [Sinusoidal Reg] [OK] [OK] .

From the List window

Tap [SetGraph][Setting...], or .

On the Set StatGraphs dialog box that appears, configure a StatGraph setup with the setting shown below, and then tap [Set].

Type: SinR

Tap  to draw the graph.

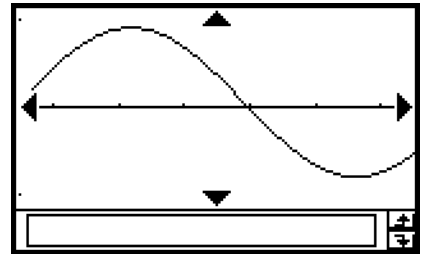

The following is the sinusoidal regression model formula.

$$y = a \cdot \sin(b \cdot x + c) + d$$

$$\bullet MSe = \frac{1}{n - 2} \sum_{i=1}^n (y_i - (a \cdot \sin(b \cdot x_i + c) + d))^2$$

Tip

- Make sure that "Radian" is selected for the [Angle] setting on the Basic Format dialog box (page 1-9-4) before drawing a sinusoidal regression graph. The graph cannot be drawn correctly when the [Angle] setting is "Degree".
- Certain types of data may cause calculation to take a long time. This is normal and does not indicate malfunction.

Drawing a Logistic Regression Graph ($y = \frac{C}{1 + a \cdot e^{-b \cdot x}}$)

Logistic regression is best for data whose values continually increase over time, until a saturation point is reached.

• ClassPad Operation

Start the graphing operation from the Statistics application's Graph window or List window.

From the Graph window

Tap [Calc] [Logistic Reg] [OK] [OK] .

From the List window

Tap [SetGraph][Setting...], or .

On the Set StatGraphs dialog box that appears, configure a StatGraph setup with the setting shown below, and then tap [Set].

Type: LogisticR

Tap  to draw the graph.

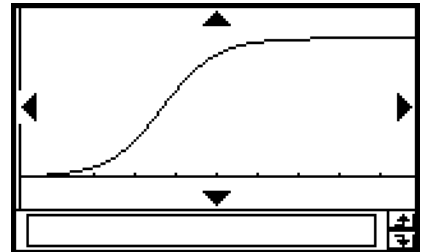

The following is the logistic regression model formula.

$$y = \frac{C}{1 + a \cdot e^{-b \cdot x}}$$

$$\bullet MSe = \frac{1}{n-2} \sum_{i=1}^n \left(y_i - \frac{C}{1 + a \cdot e^{-b \cdot x_i}} \right)^2$$

Tip

- Certain types of data may cause calculation to take a long time. This is normal and does not indicate malfunction.

Overlaying a Function Graph on a Statistical Graph







You can overlay an existing statistical graph with any type of function graph.

Example: Input the two sets of data shown below, and plot the data on a scatter plot. Next, overlay the scatter plot with the graph of $y = 2 \cdot \ln(x)$.

list1 = 0.5, 1.2, 2.4, 4.0, 5.2

list2 = -2.1, 0.3, 1.5, 2.0, 2.4

• ClassPad Operation

- (1)   Statistics
- (2) Input the data shown above.
- (3) Tap [SetGraph][Setting...].
- (4) On the Set StatGraphs dialog box that appears, configure a StatGraph setup with the settings shown below, and then tap [Set].
 Draw: On
 Type: Scatter
 XList: list1
 YList: list2
- (5) Tap  to draw the graph.
- (6) Tap the List window to make it active, and then tap .
- (7) Input the following function into line y1: $2 \times \ln(x)$.
- (8) Tap  and then [Close] to close the Graph Editor window.
- (9) Tap [SetGraph] on the menu bar. On the menu that appears, select the [Graph Function] check box.
- (10) Tap  to draw the graph.

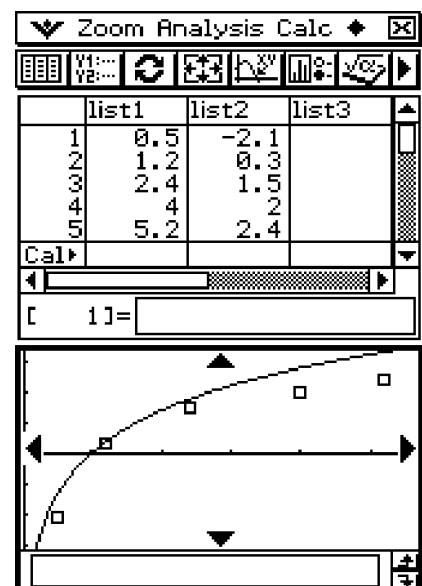













Tip

- After drawing a function graph, you can perform trace and other functions.

7-6 Using the Statistical Graph Window Toolbar

The following describes the operations you can perform using the toolbar on the Statistical Graph window.

To do this:	Tap this button:
Display the Stat Editor window	
Display the Graph Editor window	
Redraw the displayed graph	
Display the View Window dialog box	
Start a trace operation	
Display the Set StatGraphs dialog box	
Display the Main application work area window	
Start a box zoom operation	
Enlarge the display image (zoom in)	
Reduce the display image (zoom out)	
Pan the window	
Toggle the [Stat Window Auto] setting between auto and manual	



7-7 Performing Statistical Calculations

You can perform statistical calculations without drawing a graph by tapping [Calc] on the menu bar and selecting [One-Variable] or [Two-Variable].

Viewing Single-variable Statistical Calculation Results

Besides using a graph, you can also use the following procedure to view the single-variable statistics parameter values.

- **To display single-variable calculation results**

- (1) On the menu bar, tap [Calc] and then [One-Variable].
- (2) On the dialog box that appears, specify the [XList] name and select the [Freq] setting (page 7-3-3, 7-3-4).
- (3) Tap [OK].

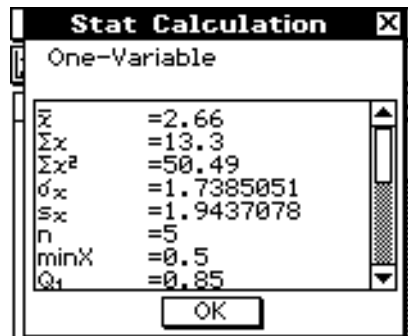

- This displays the Stat Calculation dialog box with the single-variable statistical calculation results described below. You can use the scrollbar to scroll the results.

\bar{x} :	sample mean
Σx :	sum of data
Σx^2 :	sum of squares
σ_x :	population standard deviation
s_x :	sample standard deviation
n :	sample size
minX :	minimum
Q_1 :	first quartile
Med :	median
Q_3 :	third quartile
maxX :	maximum
Mode :	mode*
ModeN :	number of data mode items
ModeF :	data mode frequency

* If "Mode = ModeStat" is shown on the Stat Calculation dialog box, it means that solutions are stored in the "ModeStat" system variable. To view the solutions, tap any list name cell on the Stat Editor window, input "ModeStat", and then tap **EXE**. This will display the "ModeStat" system variable contents in the list.

Viewing Paired-variable Statistical Calculation Results

Besides using a graph, you can also use the following procedure to view the paired-variable statistics parameter values.

- **To display paired-variable calculation results**

- (1) On the menu bar, tap [Calc] and then [Two-Variable].
- (2) On the dialog box that appears, specify the [XList] name and [YList] name, and select the [Freq] setting (page 7-3-3, 7-3-4).
- (3) Tap [OK].

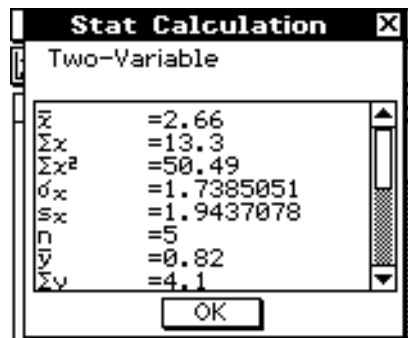

- This displays the Stat Calculation dialog box with the paired-variable statistical calculation results described below. You can use the scrollbar to scroll the results.

- \bar{x} : sample mean of sample XList data
- Σx : sum of XList data
- Σx^2 : sum of squares of XList data
- σ_x : population standard deviation of XList data
- s_x : sample standard deviation of XList data
- n : sample size
- \bar{y} : sample mean of sample YList data
- Σy : sum of YList data
- Σy^2 : sum of squares of YList data
- σ_y : population standard deviation of YList data
- s_y : sample standard deviation of YList data
- Σxy : sum of products of XList and YList data
- minX : minimum of XList data
- maxX : maximum of XList data
- minY : minimum of YList data
- maxY : maximum of YList data

Viewing Regression Calculation Results

To view regression calculation results, tap [Calc] on the menu bar and then tap the type of calculation results you want.



To view these calculation results:	Tap this option:
Linear regression	Linear Reg
Med-Med	MedMed Line
Quadratic regression	Quadratic Reg
Cubic regression	Cubic Reg
Quartic regression	Quartic Reg
Logarithmic regression	Logarithmic Reg
Exponential regression ($y = a \cdot e^{b \cdot x}$)	Exponential Reg
Exponential regression ($y = a \cdot b^x$)	abExponential Reg
Power regression	Power Reg
Sinusoidal regression	Sinusoidal Reg
Logistic regression	Logistic Reg

- You can also use the [DispStat] option to display the last calculated statistical results. For details about regression calculation results, see “7-5 Graphing Paired-Variable Statistical Data”.

Residual Calculation

Residual calculation calculates the distance (residual) between the regression model and an actual plotted point (y -coordinates) during regression calculations.

• ClassPad Operation

- (1)   Statistics
 - (2) Input the data you want into a list.
 - (3) Tap [Calc] and then [Linear Reg].
 - (4) On the dialog box that appears, tap the [Copy Residual] down arrow button, and then select [On] or the list into which you want to copy the residual values.
- Values assigned to the “residual” system variable shows the vertical distances between actually plotted points and the regression model.
 - A positive value indicates a plot that is higher than the regression model, while a negative value indicates a plot that is lower.
 - Whenever the [Copy Residual] setting is configured as described above, the ClassPad automatically assigns residual data to a system variable named “residual” when you perform a regression calculation. You can use the following procedure to view the current “residual” system variable values.



- To view “residual” system variable values

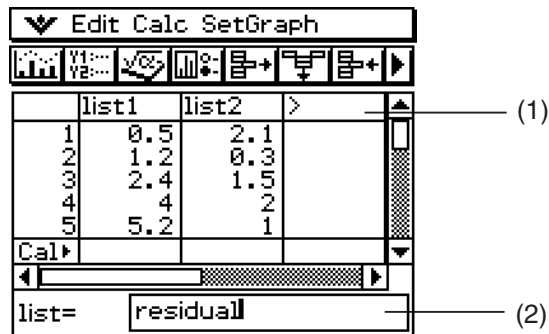

(1) Tap here.

(2) Tap here, and enter “residual”.

- To input lower-case alpha characters, tap the soft keyboard’s **abc** tab.

(3) Tap **EXE**.

Copying a Regression Formula to the Graph & Table Application

You can use the following procedure to copy the calculated result of a regression formula to the Graph & Table application. There you can use Graph functions to edit and graph the formula, and perform other operations.

- **ClassPad Operation**

(1) On the List window menu bar, tap [Calc] and then [Linear Reg].

(2) On the dialog box that appears, tap the [Copy Formula] down arrow button, and then select the Graph & Table line number (y1 through y20) to which you want to copy the formula.

(3) Tap [OK].

- This copies the calculated regression expression to the line (y1 through y20) you selected.

7-8 Test, Confidence Interval, and Distribution Calculations

You can use a wizard to perform test, confidence interval and distribution calculations in the Statistics application or write a program in the Program application. In the Statistics application, you can perform the calculations using the wizard that you launch by tapping [Calc] on the menu bar. The following is a general overview of the steps that are involved.

Statistics Application Calculations

1. Tap [Calc] and then tap [Test], [Interval] or [Distribution].
2. Select the calculation type and data type, then input the necessary values and conditions.
3. Execute the calculation and display its results.
4. Graph the results, if you want.
 - You cannot graph interval calculations and inverse distribution calculations.

Selecting the [Help] check box of each wizard will display the description of the commands, values and calculation results.

For more details and examples, see “7-9 Tests”, “7-10 Confidence intervals” and “7-11 Distributions”.

Program Application Calculations

1. Use statistical commands to build the necessary expressions and write them into a program.
2. Write the “DispStat” command into the program.
 - The “DispStat” is a command for displaying statistical calculation results. Statistical calculation results cannot be displayed unless the program includes a “DispStat” command.
3. Save the program.
4. Run the program.

Example 1: 1-Sample ZTest μ condition : \neq μ_0 : 0 σ : 3 \bar{x} : 24.5 n : 48**ClassPad Operation**(1)  (2) Tap .

(3) On the New File dialog box that appears, configure the settings as described below.

Type: Program(Normal)

Folder: Select the name of the folder where you want to save the program you are creating.

Name: Enter a file name for the program.

Example: ztestone

(4) Tap [OK].

(5) Input commands and values for the statistical expression, and then tap .(6) Input the "DispStat" command, and then tap .

```

ztestone |N|
OneSampleZTest "≠",0,3,24
.5,48
DispStat
|

```

(7) Tap  to save the program.(8) Tap .

(9) On the dialog box that appears, tap the [Name] down arrow button, and then tap the name of the file you input in step (3).

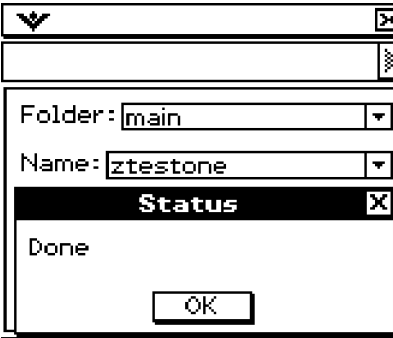
(10) Tap .

```

One-Sample ZTest
Data=Variable
  μ ≠ 0
  z = 56.580326
  prob = 0
  x̄ = 24.5
  n = 48

```

■ Example 2: Two-Way ANOVA

The values in the table below are measurement results that show how the durability of a metal product is affected by changes in heat treatment time (A) and temperature (B). Experiments were conducted twice under each condition.

	Temperature B1	Temperature B2
Time A1	113, 116	139, 132
Time A2	133, 131	126, 122

Perform analysis of variance on the null hypotheses listed below, using a 5% level of significance.

H_0 : Change in time does not affect durability.

H_0 : Change in treatment temperature does not affect durability.

H_0 : Changes in time and treatment temperature do not affect durability.

Use the ClassPad Two-Way ANOVA test to test the above hypotheses. Input the following measurement data into the indicated lists. This data is from the table above.

list1 (FactorList(A)) = {1,1,1,1,2,2,2,2}

list2 (FactorList(B)) = {1,1,2,2,1,1,2,2}

list3 (DependentList) = {113,116,139,132,133,131,126,122}

● ClassPad Operation

(1)  

(2) Tap .

(3) On the New File dialog box that appears, configure the settings as described below.

Type: Program(Normal)

Folder: Select the name of the folder where you want to save the program you are creating.

Name: Enter a file name for the program.

Example: hyp

(4) Tap [OK].

(5) Input commands and values for the statistical expression, and then tap .

(6) Input the "DispStat" command, and then tap .

```
hyp      | N
(1,1,1,1,2,2,2,2)⇒list1
(1,1,2,2,1,1,2,2)⇒list2
(113,116,139,132,133,131,
126,122)⇒list3
TwoWayANOVA list1,list2,lis
t3
DispStat
|
```

(7) Tap  to save the program.

(8) Tap .

(9) On the dialog box that appears, tap the [Name] down arrow button, and then tap the name of the file you input in step (3).

(10) Tap .

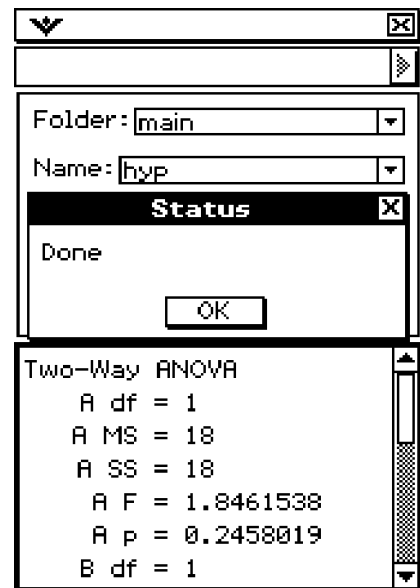

The above results indicate that altering the time is not significant, altering the temperature is significant, and interaction between time and temperature is highly significant.



7-9 Tests

The following is a list of tests, and a description of what each one tests for.

Test Name	Description
Z Test	The Z Test provides a variety of different tests based on standard deviation based tests. They make it possible to test whether or not a sample accurately represents the population when the standard deviation of a population (such as the entire population of a country) is known from previous tests.
1-Sample Z Test	Tests a single sample mean against the known mean of the null hypothesis when the population standard deviation is known. The normal distribution is used for the 1-sample Z test.
2-Sample Z Test	Tests the difference between two means when the standard deviations of the two populations are known. The normal distribution is used for the 2-sample Z test.
1-Prop Z Test	Tests a single sample proportion against the known proportion of the null hypothesis. The normal distribution is used for the 1-Prop Z test.
2-Prop Z Test	Tests the difference between two sample proportions. The normal distribution is used for the 2-prop Z test.
t Test	Used instead of the Z Test when the population standard deviation is unknown.
1-Sample t Test	Tests a single sample mean against the known mean of the null hypothesis when the population standard deviation is unknown. The t distribution is used for the 1-sample t test.
2-Sample t Test	Tests the difference between two means when the standard deviations of the two populations are unknown. The t distribution is used for the 2-sample t test.
Linear Regression t Test	Tests the linear relationship between the paired variables (x, y) . The method of least squares is used to determine a and b , which are the coefficients of the regression formula $y = a + bx$. The p -value is the probability of the sample regression slope (b) provided that the null hypothesis is true, $\beta = 0$. The t distribution is used for the linear regression t test.
χ^2 Test	Tests the independence of two categorical variables arranged in matrix form. The χ^2 test for independence compares the observed matrix to the expected theoretical matrix. The χ^2 distribution is used for the χ^2 test.
2-Sample F Test	Tests the ratio between sample variances of two independent random samples. The F distribution is used for the 2-sample F test.



Test Name	Description
ANOVA	Tests the hypothesis that the population means of multiple populations are equal.
One-Way ANOVA	Tests the ratio between the variation in sample means of several populations compared to variation among the units within the individual samples in a single factor experiment. The F distribution is used for the one-way ANOVA test.
Two-Way ANOVA	Tests the ratio between the variation among the levels compared to variation within the treatments in a two factor experiment. The F distribution is used for the two-way ANOVA test.

The following pages explain how to perform various statistical calculations based on the above principles. Further details about statistical theory and terminology can be found in any standard statistics textbook.

Tip

- Always make sure you insert one space between a command and its parameters. In the following examples, spaces are indicated as shown below.

Command: OneSampleZTest



Indicates a space.

Test Command List

■ Z Test

1-Sample Z Test

Menu: [Test]-[One-Sample ZTest]

Description: Tests a hypothesis relative to a population mean when population standard deviation is known. A 1-Sample Z Test is used for normal distribution.

$$Z = \frac{\bar{x} - \mu_0}{\frac{\sigma}{\sqrt{n}}}$$

\bar{x} : sample mean

μ_0 : assumed population mean

σ : population standard deviation

n : sample size

Definition of Terms

μ condition : population mean value test conditions (" \neq " specifies two-tail test, " $<$ " specifies lower one-tail test, " $>$ " specifies upper one-tail test.)

μ_0 : assumed population mean

σ : population standard deviation ($\sigma > 0$)

List : data list

Freq : frequency (1 or list name)

\bar{x} : sample mean

n : sample size (positive integer)

Calculation Result Output

- $\mu \neq 0$: test condition
- z : z value
- p : p -value
- \bar{x} : sample mean
- s_x : sample standard deviation (Displayed only for list format.)
- n : sample size

Example

Mean : 131
 Sample size : 10
 Population standard deviation : 19
 Assumed population mean : 120

• Statistics Wizard Operation

- (1) On the menu bar, tap [Calc] and then [Test].
- (2) Select [One-Sample ZTest] and [Variable], and then tap [Next >>].
- (3) Select the μ condition [$>$] and input values.
- (4) Tap [Next >>].
- (5) To display the graph, tap .

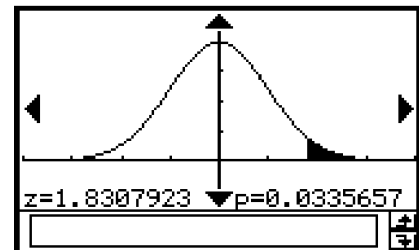
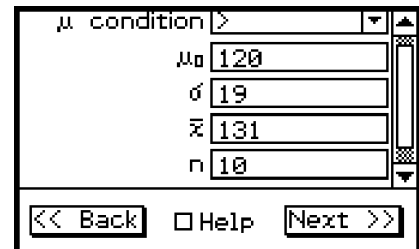
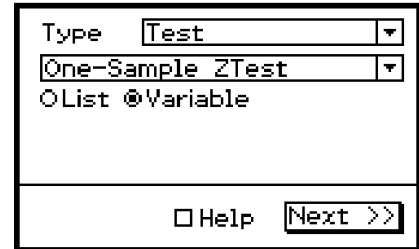

• Program, eActivity or Main Application

Command: OneSampleZTest□

Command Syntax

Syntax 1 (list format)

" μ condition", μ_0 value, σ value, List, Freq (or 1)
 * "Freq" can be omitted. Doing so sets "1" for "Freq".

Syntax 2 (parameter format)

" μ condition", μ_0 value, σ value, \bar{x} value, n value

Input Example:

Syntax 1 (list format)

OneSampleZTest " \neq ",0,1,list1,1

Syntax 2 (parameter format)

OneSampleZTest ">",120,19,131,10

2-Sample Z Test**Menu:** [Test]-[Two-Sample ZTest]**Description:** Tests a hypothesis relative to the population mean of two populations when the standard deviations of the two populations are known. A 2-Sample Z Test is used for normal distributions.

$$Z = \frac{\bar{x}_1 - \bar{x}_2}{\sqrt{\frac{\sigma_1^2}{n_1} + \frac{\sigma_2^2}{n_2}}}$$

 \bar{x}_1 : sample mean of sample 1 data \bar{x}_2 : sample mean of sample 2 data σ_1 : population standard deviation of sample 1 σ_2 : population standard deviation of sample 2 n_1 : size of sample 1 n_2 : size of sample 2**Definition of Terms**

μ_1 condition : population mean value test conditions (“≠” specifies two-tail test, “<” specifies one-tail test where sample 1 is less than sample 2, “>” specifies one-tail test where sample 1 is greater than sample 2).

σ_1 : population standard deviation of sample 1 ($\sigma_1 > 0$)

σ_2 : population standard deviation of sample 2 ($\sigma_2 > 0$)

List(1) : list where sample 1 data is located

List(2) : list where sample 2 data is located

Freq(1) : frequency of sample 1 (1 or list name)

Freq(2) : frequency of sample 2 (1 or list name)

\bar{x}_1 : sample mean of sample 1 data

n_1 : size of sample 1 (positive integer)

\bar{x}_2 : sample mean of sample 2 data

n_2 : size of sample 2 (positive integer)

Calculation Result Output

$\mu_1 \neq \mu_2$: test condition

z : z value

p : p -value

\bar{x}_1 : sample mean of sample 1 data

\bar{x}_2 : sample mean of sample 2 data

s_{x1} : sample standard deviation of sample 1 (Displayed only for list format.)

s_{x2} : sample standard deviation of sample 2 (Displayed only for list format.)

n_1 : size of sample 1

n_2 : size of sample 2



Example

	Sample A	Sample B
Size	40	45
Standard deviation	23.16	18.51
Mean	65.43	71.87

μ_1 condition \neq
 σ_1 23.16
 σ_2 18.51
 \bar{x}_1 65.43
 n_1 40
 \bar{x}_2 71.87
 n_2 45

• **Statistics Wizard Operation**

- (1) On the menu bar, tap [Calc] and then [Test].
- (2) Select [Two-Sample ZTest] and [Variable], and then tap [Next >>].
- (3) Select the μ_1 condition [\neq] and input values.
- (4) Tap [Next >>].
- (5) To display the graph, tap .

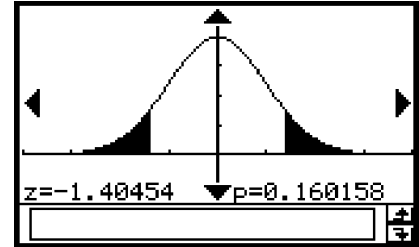

• **Program, eActivity or Main Application**

Command: TwoSampleZTest□

Command Syntax

Syntax 1 (list format)

“ μ_1 condition”, σ_1 value, σ_2 value, List(1), List(2), Freq(1) (or 1), Freq(2) (or 1)
 * “Freq” can be omitted. Doing so sets “1” for “Freq”.

Syntax 2 (parameter format)

“ μ_1 condition”, σ_1 value, σ_2 value, \bar{x}_1 value, n_1 value, \bar{x}_2 value, n_2 value

Input Example:

Syntax 1 (list format)

TwoSampleZTest “ \neq ”,1,1,list1,list2,1,1

Syntax 2 (parameter format)

TwoSampleZTest “ \neq ”,23.16,18.51,65.43,40,71.87,45

1-Prop Z Test

Menu: [Test]-[One-Prop ZTest]

Description: This command tests whether successes achieve a fixed proportion.
 A 1-Prop Z Test is used for normal distribution.

$$Z = \frac{\frac{x}{n} - p_0}{\sqrt{\frac{p_0(1-p_0)}{n}}}$$

p_0 : expected sample proportion
 n : sample size

Definition of Terms

- Prop condition : sample proportion test condition (“≠” specifies two-tail test, “<” specifies lower one-tail test, “>” specifies upper one-tail test.)
- p_0 : expected sample proportion ($0 < p_0 < 1$)
- x : sample value (integer, $x \geq 0$)
- n : sample size (positive integer)

Calculation Result Output

- Prop≠0.5 : test condition
- z : z value
- p : p -value
- \hat{p} : estimated sample proportion
- n : sample size

Example

Data : 13
 Sample size : 100
 Expected proportion : 20%

• **Statistics Wizard Operation**

- (1) On the menu bar, tap [Calc] and then [Test].
- (2) Select [One-Prop ZTest] and then tap [Next >>].
- (3) Select Prop condition [≠] and input values.
- (4) Tap [Next >>].
- (5) To display the graph, tap .

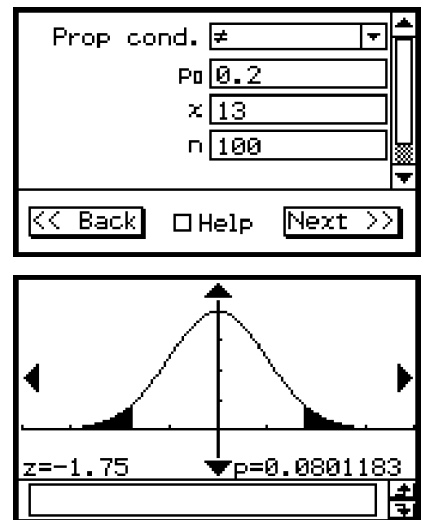

• **Program, eActivity or Main Application**

Command: OnePropZTest□

Command Syntax

“Prop condition”, p_0 value, x value, n value

Input Example:

OnePropZTest “≠”,0.2,13,100

2-Prop Z Test

Menu: [Test]-[Two-Prop ZTest]

Description: This command compares the proportion of successes for two populations. A 2-Prop Z Test is used for normal distribution.

$$Z = \frac{\frac{x_1}{n_1} - \frac{x_2}{n_2}}{\sqrt{\hat{p}(1-\hat{p})\left(\frac{1}{n_1} + \frac{1}{n_2}\right)}}$$

- x_1 : data value of sample 1
- x_2 : data value of sample 2
- n_1 : size of sample 1
- n_2 : size of sample 2
- \hat{p} : estimated sample proportion

Definition of Terms

- p_1 condition : sample proportion test conditions (“≠” specifies two-tail test, “<” specifies one-tail test where sample 1 is smaller than sample 2, “>” specifies one-tail test where sample 1 is greater than sample 2.)
- x_1 : data value (integer, $x_1 \geq 0$) of sample 1
- n_1 : size of sample 1 (positive integer)
- x_2 : data value (integer, $x_2 \geq 0$) of sample 2
- n_2 : size of sample 2 (positive integer)

Calculation Result Output

- $p_1 > p_2$: test condition
- z : z value
- p : p -value
- \hat{p}_1 : estimated proportion of sample 1
- \hat{p}_2 : estimated proportion of sample 2
- \hat{p} : estimated sample proportion
- n_1 : size of sample 1
- n_2 : size of sample 2

Example

Data1 : 220 , sample size : 400
Data2 : 184 , sample size : 400

• Statistics Wizard Operation

- (1) On the menu bar, tap [Calc] and then [Test].
- (2) Select [Two-Prop ZTest] and then tap [Next >>].
- (3) Select p_1 condition [>] and input values.
- (4) Tap [Next >>].
- (5) To display the graph, tap .

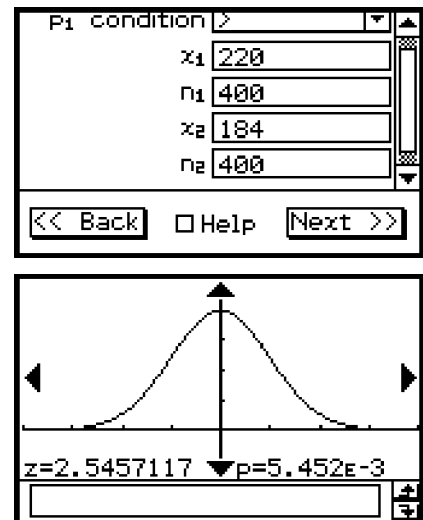

• Program, eActivity or Main Application

Command: TwoPropZTest

Command Syntax

“ p_1 condition”, x_1 value, n_1 value, x_2 value, n_2 value

Input Example:

TwoPropZTest “>”,220,400,184,400

■ *t* Test

1-Sample *t* Test

Menu: [Test]-[One-Sample TTest]

Description: Tests a hypothesis relative to a population mean when population standard deviation is unknown. A 1-Sample *t* Test is used for *t* distribution.

$$t = \frac{\bar{x} - \mu_0}{\frac{s_x}{\sqrt{n}}}$$

\bar{x} : sample mean

μ_0 : assumed population mean

s_x : sample standard deviation

n : sample size

Definition of Terms

μ condition : population mean value test conditions (“≠” specifies two-tail test, “<” specifies lower one-tail test, “>” specifies upper one-tail test.)

μ_0 : assumed population mean

List : data list

Freq : frequency (1 or list name)

\bar{x} : sample mean

s_x : sample standard deviation ($s_x > 0$)

n : sample size (positive integer)

Calculation Result Output

$\mu \neq 11.3$: test condition

t : t value

p : p -value

\bar{x} : sample mean

s_x : sample standard deviation

n : sample size

Example 1 (calculation with list)

List : { 330, 240, 260, 390, 400, 360, 200, 180, 300 }

Assumed population mean : 250

• Statistics Wizard Operation

- (1) Input the data into [list1] in the Stat Editor.
- (2) On the menu bar, tap [Calc] and then [Test].
- (3) Select [One-Sample TTest] and [List], and then tap [Next >>].
- (4) Select the μ condition [≠] and input μ_0 250.
- (5) Select List [list1] and Freq [1].
- (6) Tap [Next >>].

(7) To display the graph, tap .

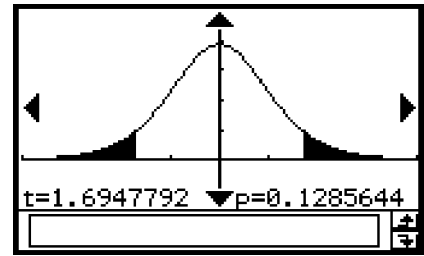

Example 2 (calculation with parameter)

Standard deviation : 80.6

Mean : 295.6

Sample size : 9

Assumed population mean : 250

• **Statistics Wizard Operation**

- (1) On the menu bar, tap [Calc] and then [Test].
- (2) Select [One-Sample TTest] and [Variable], and then tap [Next >>].
- (3) Select the μ condition [\neq] and input values.
- (4) Tap [Next >>].
- (5) To display the graph, tap .

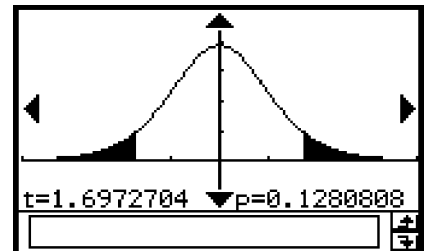

• **Program, eActivity or Main Application**

Command: OneSampleTTest

Command Syntax

Syntax 1 (list format)

“ μ condition”, μ_0 value, List, Freq (or 1)
* “Freq” can be omitted. Doing so sets “1” for “Freq”.

Syntax 2 (parameter format)

“ μ condition”, μ_0 value, \bar{x} value, s_x value, n value

Input Example:

Syntax 1 (list format)

OneSampleTTest “ \neq ”,250,list1,1

Syntax 2 (parameter format)

OneSampleTTest “ \neq ”,250,295.6,80.6,9

2-Sample t Test

Menu: [Test]-[Two-Sample TTest]

Description: This command compares the population means of two populations when population standard deviation is unknown. A 2-Sample t Test is used for t distribution.

$$t = \frac{\bar{x}_1 - \bar{x}_2}{\sqrt{\frac{s_{x1}^2}{n_1} + \frac{s_{x2}^2}{n_2}}}$$

\bar{x}_1 : sample mean of sample 1 data
 \bar{x}_2 : sample mean of sample 2 data
 s_{x1} : sample standard deviation of sample 1
 s_{x2} : sample standard deviation of sample 2
 n_1 : size of sample 1
 n_2 : size of sample 2

This formula is applicable when the population standard deviations of the two populations are not equal. The denominator is different when the population standard deviations are equal.

The t distribution degrees of freedom df and s_p differ according to whether the population standard deviations of the two populations are equal.

When the two population standard deviations are equal (pooled)

$$df = n_1 + n_2 - 2$$

$$s_p = \sqrt{\frac{(n_1-1)s_{x1}^2 + (n_2-1)s_{x2}^2}{n_1 + n_2 - 2}}$$

When the two population standard deviations are not equal (not pooled)

$$df = \frac{1}{\frac{C^2}{n_1-1} + \frac{(1-C)^2}{n_2-1}}$$

$$C = \frac{\frac{s_{x1}^2}{n_1}}{\left(\frac{s_{x1}^2}{n_1} + \frac{s_{x2}^2}{n_2}\right)}$$

Definition of Terms

- μ_1 condition : sample mean value test conditions (“ \neq ” specifies two-tail test, “ $<$ ” specifies one-tail test where sample 1 is smaller than sample 2, “ $>$ ” specifies one-tail test where sample 1 is greater than sample 2.)
- List(1) : list where sample 1 data is located
 List(2) : list where sample 2 data is located
 Freq(1) : frequency of sample 1 (1 or list name)
 Freq(2) : frequency of sample 2 (1 or list name)
 Pooled : On or Off
 \bar{x}_1 : sample mean of sample 1 data
 s_{x1} : sample standard deviation of sample 1 ($s_{x1} > 0$)
 n_1 : size of sample 1 (positive integer)
 \bar{x}_2 : sample mean of sample 2 data
 s_{x2} : sample standard deviation of sample 2 ($s_{x2} > 0$)
 n_2 : size of sample 2 (positive integer)



Calculation Result Output

$\mu_1 \neq \mu_2$:	test condition
t :	t value
p :	p -value
df :	degrees of freedom
\bar{x}_1 :	sample mean of sample 1 data
\bar{x}_2 :	sample mean of sample 2 data
s_{x1} :	sample standard deviation of sample 1
s_{x2} :	sample standard deviation of sample 2
s_p :	Pooled sample standard deviation (Displayed only when pooling is turned on.)
n_1 :	size of sample 1
n_2 :	size of sample 2

Example

list1 : {−8522, 316, −9001, 6470, 8956, 4348, 8571, 2142, −7139, 9925, 1260}
list2 : {176, 5498, 4830, 9457, 6486, 9607, −8334, −1771, 7919, −2997}

• Statistics Wizard Operation

- (1) Input the data into [list1] and [list2] in the Stat Editor.
- (2) On the menu bar, tap [Calc] and then [Test].
- (3) Select [Two-Sample TTest] and [List], and then tap [Next >>].
- (4) Select the μ_1 condition [<].
- (5) Select List(1) [list1], List(2) [list2], Freq(1) [1], Freq(2) [1] and Pooled [Off].
- (6) Tap [Next >>].
- (7) To display the graph, tap the .

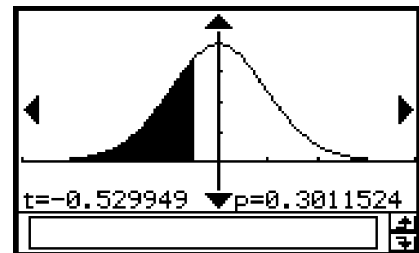

•Program, eActivity or Main Application

Command: TwoSampleTTest□

Command Syntax

Syntax 1 (list format)

“ μ_1 condition”, List(1), List(2), Freq(1) (or 1), Freq(2) (or 1), Pooled condition (On or Off)

* “Freq” can be omitted. Doing so sets “1” for “Freq”.

* “Pooled” can be omitted. Doing so sets “Off” for “Pooled”.

Syntax 2 (parameter format)

“ μ_1 condition”, \bar{x}_1 value, s_{x1} value, n_1 value, \bar{x}_2 value, s_{x2} value, n_2 value, Pooled condition (On or Off)

* “Pooled” can be omitted. Doing so sets “Off” for “Pooled”.

Input Example:

Syntax 1 (list format)

TwoSampleTTest "<",list1,list2,1,1,Off

Syntax 2 (parameter format)

TwoSampleTTest "≠",107.5,0.78,10,97.5,0.65,12,Off

Linear Regression *t* Test

Menu: [Test]-[Linear Reg TTest]

Description: This command treats two groups of data as paired variables (x, y). The method of least squares is used to determine the most appropriate pair for the a, b coefficients of the regression formula $y = a + b \cdot x$. It also determines the correlation coefficient and t value, and calculates the strength of the relationship between x and y .

$$b = \frac{\sum_{i=1}^n (x - \bar{x})(y - \bar{y})}{\sum_{i=1}^n (x - \bar{x})^2} \quad a = \bar{y} - b \cdot \bar{x} \quad t = r \sqrt{\frac{n-2}{1-r^2}}$$

a : regression constant term (y-intercept)

b : regression coefficient (slope)

n : sample size ($n \geq 3$)

r : correlation coefficient

r^2 : coefficient of determination

Definition of Terms

β & ρ condition : test conditions (" \neq " specifies two-tail test, "<" specifies lower one-tail test, ">" specifies upper one-tail test.)

XList : x -data list

YList : y -data list

Freq : frequency (1 or list name)

Calculation Result Output

$\beta \neq 0$ & $\rho \neq 0$: test condition

t : t value

p : p -value

df : degrees of freedom

a : regression constant term (y-intercept)

b : regression coefficient (slope)

s_e : standard error of estimation

r : correlation coefficient

r^2 : coefficient of determination

Example

list1 : { 38, 56, 59, 64, 74 }
list2 : { 41, 63, 70, 72, 84 }

• **Statistics Wizard Operation**

- (1) Input the data into [list1] and [list2] in the Stat Editor.
- (2) On the menu bar, tap [Calc] and then [Test].
- (3) Select [Linear Reg TTest] and then tap [Next >>].
- (4) Select the β & ρ condition [\neq].
- (5) Select XList [list1], YList [list2] and Freq [1].
- (6) Tap [Next >>].
- (7) To display the graph, tap .

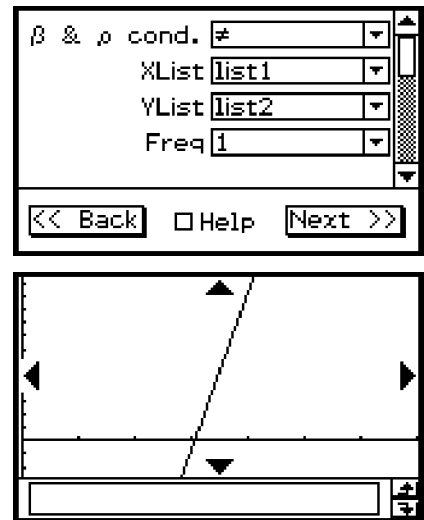

• **Program, eActivity or Main Application**

Command: LinRegTTest 

Command Syntax

“ β & ρ condition”, XList, YList, Freq (or 1)
* “Freq” can be omitted. Doing so sets “1” for “Freq”.

Input Example

LinRegTTest “ \neq ”,list1,list2,1

■ **χ^2 Test**

χ^2 Test

Menu: [Test]-[χ^2 Test]

Description: This command tests hypotheses concerning the proportion of samples included in each of a number of independent groups. The χ^2 Test command is used in the case of dichotomous variables, which are variables that have only two possible values (such as “yes” or “no”).

Expected Frequencies

$$F_{ij} = \frac{\sum_{i=1}^k x_{ij} \times \sum_{j=1}^{\ell} x_{ij}}{\sum_{i=1}^k \sum_{j=1}^{\ell} x_{ij}}$$

$$\chi^2 = \sum_{i=1}^k \sum_{j=1}^{\ell} \frac{(x_{ij} - F_{ij})^2}{F_{ij}}$$

Definition of Terms

Observed matrix: name of matrix containing observed values (positive integers in all cells for 2×2 and larger matrices; positive real numbers for one row matrices)

Calculation Result Output

χ^2 : χ^2 value





p : p -value

df : degrees of freedom

Example

$$a = \begin{bmatrix} 11 & 68 & 3 \\ 9 & 23 & 5 \end{bmatrix}$$

• Statistics Wizard Operation

- (1)  Main
- (2) Input the matrix and assign it to variable a .
- (3)  Menu  Statistics
- (4) On the menu bar, tap [Calc] and then [Test].
- (5) Select [χ^2 Test] and then tap [Next >>].
- (6) Input matrix a in the Matrix dialog box.
- (7) Tap [Next >>].
- (8) To display the graph, tap .

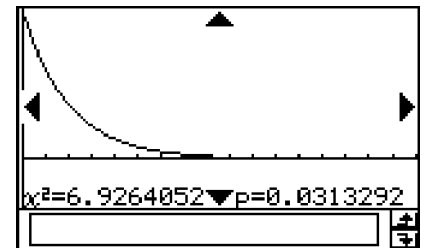
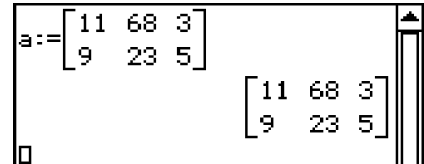

• Program, eActivity or Main Application

Command: ChiTest□

Command Syntax

Observed matrix

Input Example:

ChiTest matrixa

Tip

- The minimum size of the matrix is 1×2 . An error occurs if the matrix has only one row.
- The result of the expected frequency calculation is stored in the system variable named "Expected".

χ^2 GOF Test

Menu: [Test]-[χ^2 GOF Test]

Description: This command tests whether the frequency of sample data fits a certain distribution. For example, it can be used to determine conformance with normal distribution or binomial distribution.

$$\chi^2 = \sum_i^k \frac{(O_i - E_i)^2}{E_i}$$

$$\text{Contrib} = \left\{ \frac{(O_1 - E_1)^2}{E_1} \frac{(O_2 - E_2)^2}{E_2} \dots \frac{(O_k - E_k)^2}{E_k} \right\}$$

O_i : The i -th element of the observed list

E_i : The i -th element of the expected list

Definition of Terms

Observed list : name of list containing observed counts (all cells positive integers)

Expected list : name of list that is for saving expected frequency

df : degrees of freedom

Calculation Result Output

χ^2 : χ^2 value

p : p -value





df : degrees of freedom

Contrib : name of list specifying the contribution of each observed count

Example

list1 = {1,2,3}, list2 = {4,5,6}, $df = 1$

• Statistics Wizard Operation

- (1)  Main
- (2) Input the list1 and list2.
- (3)  Menu  Statistics
- (4) On the menu bar, tap [Calc] and then [Test].
- (5) Select [χ^2 GOF Test] and then tap [Next >>].
- (6) Select List(1) [list1], List(2) [list2] and input df 1.
- (7) Tap [Next >>].
- (8) To display the graph, tap .

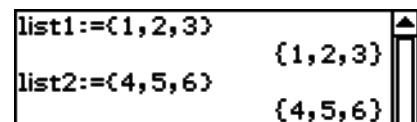
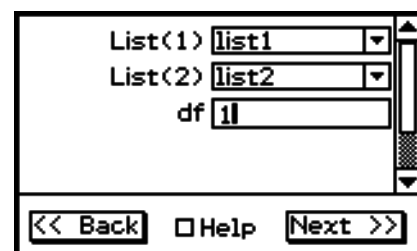
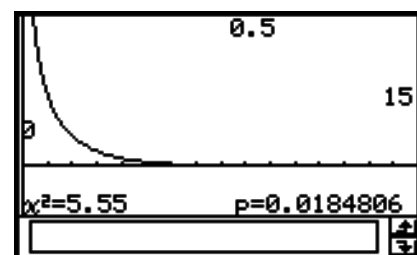
• Program, eActivity or Main Application

Command: ChiGOFTest□

Command Syntax

Observed list, Expected list, df

Input Example:

ChiGOFTest list1, list2, 1

Tip

- The calculation results χ^2 , p , df , and Contrib are stored in the system variables named " χ^2 value", " $prob$ ", " df ", and "Contrib" respectively.

2-Sample F Test

2-Sample F Test

Menu: [Test]-[Two-Sample FTest]

Description: This command tests hypotheses concerning the ratio of the population variance of two populations. A 2-Sample F Test uses F distribution.

$$F = \frac{s_{x1}^2}{s_{x2}^2}$$

Definition of Terms

- σ_1 condition: population standard deviation test conditions (“ \neq ” specifies two-tail test, “ $<$ ” specifies one-tail test where sample 1 is smaller than sample 2, “ $>$ ” specifies one-tail test where sample 1 is greater than sample 2.)
- List(1) : list where sample 1 data is located
 List(2) : list where sample 2 data is located
 Freq(1) : frequency of sample 1 (1 or list name)
 Freq(2) : frequency of sample 2 (1 or list name)
 s_{x1} : sample standard deviation of sample 1 ($s_{x1} > 0$)
 n_1 : size of sample 1 (positive integer)
 s_{x2} : sample standard deviation of sample 2 ($s_{x2} > 0$)
 n_2 : size of sample 2 (positive integer)

Calculation Result Output

- $\sigma_1 \neq \sigma_2$: test condition
 F : F value
 p : p -value
 \bar{x}_1 : sample mean of sample 1 data (Displayed only for list format.)
 \bar{x}_2 : sample mean of sample 2 data (Displayed only for list format.)
 s_{x1} : sample standard deviation of sample 1
 s_{x2} : sample standard deviation of sample 2
 n_1 : size of sample 1
 n_2 : size of sample 2

Example

list1 : { 7, -4, 18, 17, -3, -5, 1, 10, 11, -2, -3 }
 list2 : { -1, 12, -1, -3, -3, 3, -5, 5, 2, -11, -1, -3 }

• Statistics Wizard Operation

- (1) Input the data into [list1] and [list2] in the Stat Editor.
- (2) On the menu bar, tap [Calc] and then [Test].
- (3) Select [Two-Sample FTest] and [List], and then tap [Next >>].
- (4) Select the σ_1 condition [\neq].
- (5) Select List(1) [list1], List(2) [list2], Freq(1) [1] and Freq(2) [1].
- (6) Tap [Next >>].
- (7) To display the graph, tap .

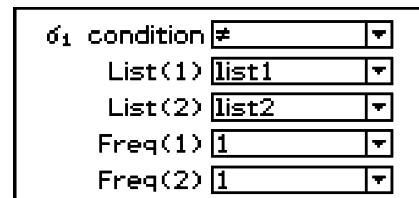
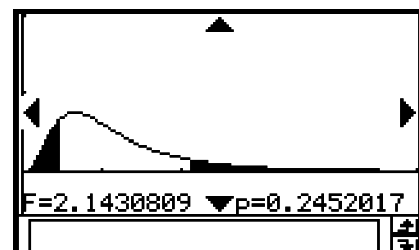
●Program, eActivity or Main Application

Command: TwoSampleFTest□

Command Syntax

Syntax 1 (list format)

“ σ_1 condition”, List(1), List(2), Freq(1) (or 1), Freq(2) (or 1)
* “Freq” can be omitted. Doing so sets “1” for “Freq”.

Syntax 2 (parameter format)

“ σ_1 condition”, s_{x1} value, n_1 value, s_{x2} value, n_2 value

Input Example

Syntax 1 (list format)

TwoSampleFTest “ \neq ”,list1,list2,1,1

Syntax 2 (parameter format)

TwoSampleFTest “ \neq ”,1.94,10,2.12,15

■ ANOVA

One-Way ANOVA

Menu: [Test]-[One-Way ANOVA]

Description: This command tests the hypothesis that the population means of multiple populations are equal. It compares the mean of one or more groups based on one independent variable or factor.

Definition of Terms

FactorList(A): list where levels of Factor A are located

DependentList: list where sample data is located

Calculation Result Output

A *df*: *df* of Factor A

A *MS*: *MS* of Factor A

A *SS*: *SS* of Factor A

A *F*: *F* value of Factor A

A *p*: *p*-value of Factor A

Err*df*: *df* of error

Err*MS*: *MS* of error

Err*SS*: *SS* of error

df: degrees of freedom

SS: sum of squares

MS: mean square



Example

list1 : { 7, 4, 6, 6, 5 }

list2 : { 6, 5, 5, 8, 7 }

list3 : { 4, 7, 6, 7, 6 }

• Statistics Wizard Operation

- (1) Input the data into [list1], [list2] and [list3] in the Stat Editor.
- (2) On the menu bar, tap [Calc] and then [Test].
- (3) Select [One-Way ANOVA] and then tap [Next >>].
- (4) Select Lists [list1], [list2] and [list3].
- (5) Tap [Next >>].
- (6) To display the graph, tap .

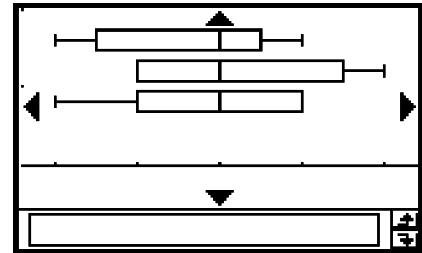
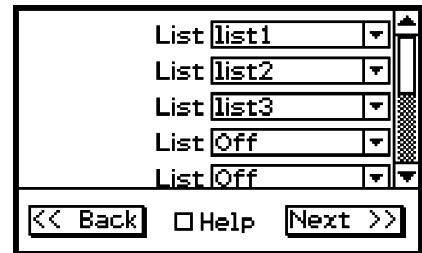

• Program, eActivity or Main Application

Command: OneWayANOVA

Command Syntax

FactorList(A), DependentList

Input Example

list1:{1,1,1,1,1,2,2,2,2,3,3,3,3}

list2:{7,4,6,6,5,6,5,5,8,7,4,7,6,7,6}

OneWayANOVA list1,list2

Two-Way ANOVA

Menu: [Test]-[Two-Way ANOVA]

Description: This command tests the hypothesis that the population means of multiple populations are equal. It examines the effect of each variable independently as well as their interaction with each other based on a dependent variable.

Definition of Terms

FactorList(A) : list where levels of Factor A are located

FactorList(B) : list where levels of Factor B are located

DependentList : list where sample data is located

Calculation Result Output

A *df* : *df* of Factor A

A *MS* : *MS* of Factor A

A *SS* : *SS* of Factor A

A *F* : *F* value of Factor A

A *p* : *p*-value of Factor A

B *df* : *df* of Factor B

B *MS* : *MS* of Factor B

B *SS* : *SS* of Factor B

B *F* : *F* value of Factor B

B *p* : *p*-value of Factor B

$AB\ df$: df of Factor A \times Factor B
 $AB\ MS$: MS of Factor A \times Factor B
 $AB\ SS$: SS of Factor A \times Factor B
 $AB\ F$: F value of Factor A \times Factor B
 $AB\ p$: p -value of Factor A \times Factor B
 Note that “ $AB\ df$ ”, “ $AB\ MS$ ”, “ $AB\ SS$ ”, “ $AB\ F$ ”, and “ $AB\ p$ ” are not displayed if there are no repeated data pairs.

$Errdf$: df of error
 $ErrMS$: MS of error
 $ErrSS$: SS of error

df : degrees of freedom
 SS : sum of squares
 MS : mean square

Example

	Factor B1	Factor B2
Factor A1	14.5, 11, 10.8, 14.3, 10 (list1)	16.5, 18.4, 12.7, 14, 12.8 (list2)
Factor A2	21, 18.5, 15.2, 17.9, 21.6 (list3)	43.2, 35.2, 28.7, 41.3, 47.1 (list4)

• Statistics Wizard Operation

- (1) Input the data into [list1] through [list4] in the Stat Editor.
- (2) On the menu bar, tap [Calc] and then [Test].
- (3) Select [Two-Way ANOVA] and then tap [Next >>].
- (4) Select Data Table type [2x2].
- (5) Select Data Table lists [list1] through [list4].
- (6) Tap [Next >>].

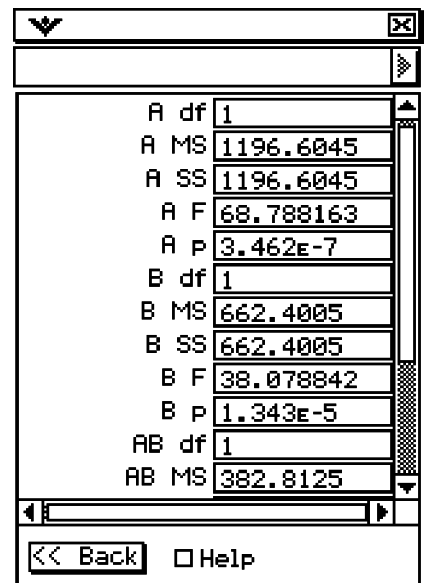

• Program, eActivity or Main Application

Command: TwoWayANOVA

Command Syntax

FactorList(A), FactorList(B), DependentList

Input Example

$list1$:{1,1,1,1,1,1,1,1,1,2,2,2,2,2,2,2,2,2,2,2}
 $list2$:{1,1,1,1,1,2,2,2,2,2,1,1,1,1,1,2,2,2,2,2}
 $list3$:{14.5,11,10.8,14.3,10,16.5,18.4,12.7,14,12.8, 21,18.5,15.2,17.9,21.6,43.2, 35.2,28.7,41.3,47.1}
 TwoWayANOVA list1,list2,list3

7-10 Confidence Intervals

A confidence interval is a range of values that has a specified probability of containing the parameter being estimated.

A confidence interval that is too broad makes it difficult to get an idea of where the parameter (actual value) is located. A narrow confidence interval, on the other hand, limits the parameter range and makes it possible to obtain highly accurate results.

The commonly used confidence levels are 68%, 95% and 99%. Raising the confidence level broadens the confidence interval. Conversely, lowering the confidence level narrows the confidence interval, but it also creates the risk that parameters will be missed. With a confidence interval of 95%, for example, there is a 5% probability that a parameter will not be within the interval.

The following is a list of confidence intervals and a description of what each obtains.

Confidence Interval Name	Description
<i>Z</i> Confidence Interval	
1-Sample <i>Z</i> Interval	Calculates the confidence interval for the population mean based on a sample mean and known population standard deviation.
2-Sample <i>Z</i> Interval	Calculates the confidence interval for the difference between population means based on the difference between sample means when the population standard deviations are known.
1-Prop <i>Z</i> Interval	Calculates the confidence interval for the population proportion based on a single sample proportion.
2-Prop <i>Z</i> Interval	Calculates the confidence interval for the difference between population proportions based on the difference between two sample proportions.
<i>t</i> Confidence Interval	
1-Sample <i>t</i> Interval	Calculates the confidence interval for the population mean based on a sample mean and a sample standard deviation when the population standard deviation is not known.
2-Sample <i>t</i> Interval	Calculates the confidence interval for the difference between population means based on the difference between sample means and sample standard deviations when the population standard deviations are not known.

■ General Confidence Interval Precautions

If you input a C-Level (confidence level) value in the range of $0 \leq \text{C-Level} < 1$, the value you input is used. To specify a C-Level of 95%, for example, input "0.95".



Confidence Interval Command List

■ Z Confidence Interval

1-Sample Z Interval

Menu: [Interval]-[One-Sample ZInt]

Description: This command obtains the confidence interval for the population mean when the population standard deviation is known.

The confidence interval is obtained using the following expressions.

$$Lower = \bar{x} - Z\left(\frac{\alpha}{2}\right) \frac{\sigma}{\sqrt{n}}$$

$$Upper = \bar{x} + Z\left(\frac{\alpha}{2}\right) \frac{\sigma}{\sqrt{n}}$$

α is the significance level, and $100(1 - \alpha)\%$ is the confidence level. When the confidence level is 95%, for example, you would input 0.95, which produces $\alpha = 1 - 0.95 = 0.05$.

Definition of Terms

- C-Level : confidence level ($0 \leq \text{C-Level} < 1$)
- σ : population standard deviation ($\sigma > 0$)
- List : list where sample data is located
- Freq : frequency of sample (1 or list name)
- \bar{x} : sample mean
- n : sample size (positive integer)

Calculation Result Output

- Lower : interval lower limit (left edge)
- Upper : interval upper limit (right edge)
- \bar{x} : sample mean
- s_x : sample standard deviation (Displayed only for list format.)
- n : sample size

Example 1 (calculation with list)

list1 : { 299.4, 297.7, 301, 298.9, 300.2, 297 }
 Population standard deviation : 3
 Significance level : 5% (= confidence level : 95%)

• Statistics Wizard Operation

- (1) Input the data into [list1] in the Stat Editor.
- (2) On the menu bar, tap [Calc] and then [Interval].
- (3) Select [One-Sample ZInt] and [List], and then tap [Next >>].
- (4) Input values.
- (5) Select List [list1] and Freq [1].
- (6) Tap [Next >>].

C-Level
 σ
 List
 Freq
 << Back Help Next >>

Lower
 Upper
 \bar{x}
 s_x
 n
 << Back Help

Example 2 (calculation with parameter)

Mean : 300
Sample size : 6
Population standard deviation : 3
Significance level : 5% (= confidence level : 95%)

• **Statistics Wizard Operation**

- (1) On the menu bar, tap [Calc] and then [Interval].
- (2) Select [One-Sample ZInt] and [Variable], and then tap [Next >>].
- (3) Input values.
- (4) Tap [Next >>].

C-Level	0.95
σ	3
\bar{x}	300
n	6
<input type="button" value="Back"/> <input type="checkbox"/> Help <input type="button" value="Next >>"/>	

Lower	297.59954
Upper	302.40046
\bar{x}	300
n	6
<input type="button" value="Back"/> <input type="checkbox"/> Help	

• **Program, eActivity or Main Application**

Command: OneSampleZInt

Command Syntax

Syntax 1 (list format)

C-Level value, σ value, List, Freq (or 1)
* "Freq" can be omitted. Doing so sets "1" for "Freq".

Syntax 2 (parameter format)

C-Level value, σ value, \bar{x} value, n value

Input Example:

Syntax 1 (list format)

OneSampleZInt 0.95,3,list1,1

Syntax 2 (parameter format)

OneSampleZInt 0.95,3,300,6

2-Sample Z Interval

Menu: [Interval]-[Two-Sample ZInt]

Description: This command obtains the confidence interval for the difference between population means when the population standard deviations of two populations are known.

The confidence interval is obtained using the following expressions.
The confidence level is 100 (1 - α)%.

$$Lower = (\bar{x}_1 - \bar{x}_2) - Z\left(\frac{\alpha}{2}\right) \sqrt{\frac{\sigma_1^2}{n_1} + \frac{\sigma_2^2}{n_2}}$$

$$Upper = (\bar{x}_1 - \bar{x}_2) + Z\left(\frac{\alpha}{2}\right) \sqrt{\frac{\sigma_1^2}{n_1} + \frac{\sigma_2^2}{n_2}}$$

\bar{x}_1 : sample mean of sample 1 data
 \bar{x}_2 : sample mean of sample 2 data
 σ_1 : population standard deviation of sample 1
 σ_2 : population standard deviation of sample 2
 n_1 : size of sample 1
 n_2 : size of sample 2



Definition of Terms

- C-Level : confidence level ($0 \leq \text{C-Level} < 1$)
- σ_1 : population standard deviation of sample 1 ($\sigma_1 > 0$)
- σ_2 : population standard deviation of sample 2 ($\sigma_2 > 0$)
- List(1) : list where sample 1 data is located
- List(2) : list where sample 2 data is located
- Freq(1) : frequency of sample 1 (1 or list name)
- Freq(2) : frequency of sample 2 (1 or list name)
- \bar{x}_1 : sample mean of sample 1 data
- n_1 : size of sample 1 (positive integer)
- \bar{x}_2 : sample mean of sample 2 data
- n_2 : size of sample 2 (positive integer)

Calculation Result Output

- Lower : interval lower limit (left edge)
- Upper : interval upper limit (right edge)
- \bar{x}_1 : sample mean of sample 1 data
- \bar{x}_2 : sample mean of sample 2 data
- S_{x1} : sample standard deviation of sample 1 (Displayed only for list format.)
- S_{x2} : sample standard deviation of sample 2 (Displayed only for list format.)
- n_1 : size of sample 1
- n_2 : size of sample 2

Example

list1 : { 154, 109, 137, 115, 140 } , population standard deviation : 15.5
 list2 : { 108, 115, 126, 92, 146 } , population standard deviation : 13.5
 Significance level : 5% (= confidence level : 95%)

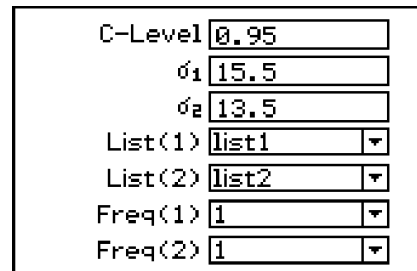

• Statistics Wizard Operation

- (1) Input the data into [list1] and [list2] in the Stat Editor.
- (2) On the menu bar, tap [Calc] and then [Interval].
- (3) Select [Two-Sample ZInt] and [List], and then tap [Next >>].
- (4) Input values.
- (5) Select List(1) [list1], List(2) [list2], Freq(1) [1] and Freq(2) [1].
- (6) Tap [Next >>].

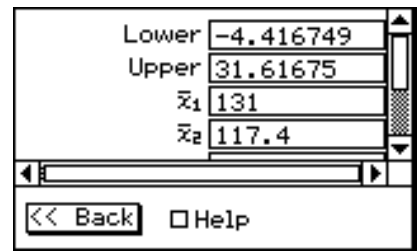

• Program, eActivity or Main Application

Command: TwoSampleZInt□

Command Syntax

Syntax 1 (list format)

C-Level value, σ_1 value, σ_2 value, List(1), List(2), Freq(1) (or 1), Freq(2) (or 1)
 * "Freq" can be omitted. Doing so sets "1" for "Freq".

Syntax 2 (parameter format)

C-Level value, σ_1 value, σ_2 value, \bar{x}_1 value, n_1 value, \bar{x}_2 value, n_2 value



Input Example:

Syntax 1 (list format)

TwoSampleZInt 0.95,15.5,13.5,list1,list2,1,1

Syntax 2 (parameter format)

TwoSampleZInt 0.95,1,1.5,418,40,402,50

1-Prop Z Interval

Menu: [Interval]-[One-Prop ZInt]

Description: This command obtains the confidence interval of the proportion of successes in a population.

The confidence interval is obtained using the following expressions.
The confidence level is 100 (1 - α)%.

$$Lower = \frac{x}{n} - Z\left(\frac{\alpha}{2}\right) \sqrt{\frac{1}{n} \left(\frac{x}{n} \left(1 - \frac{x}{n}\right)\right)} \quad n: \text{sample size}$$

x: data

$$Upper = \frac{x}{n} + Z\left(\frac{\alpha}{2}\right) \sqrt{\frac{1}{n} \left(\frac{x}{n} \left(1 - \frac{x}{n}\right)\right)}$$

Definition of Terms

- C-Level: confidence level (0 ≤ C-Level < 1)
- x : data (0 or positive integer)
- n : sample size (positive integer)

Calculation Result Output

- Lower : interval lower limit (left edge)
- Upper : interval upper limit (right edge)
- \hat{p} : estimated sample proportion
- n : sample size

Example

Data : 2048
Sample size : 4040
Significance level : 1% (= confidence level : 99%)

• **Statistics Wizard Operation**

- (1) On the menu bar, tap [Calc] and then [Interval].
- (2) Select [One-Prop ZInt] and then tap [Next >>].
- (3) Input values.
- (4) Tap [Next >>].

C-Level

x

n

<< Back Help Next >>

Lower

Upper

\hat{p}

n

<< Back Help



● **Program, eActivity or Main Application**

Command: OnePropZInt□

Command Syntax

C-Level value, x value, n value

Input Example:

OnePropZInt 0.99,2048,4040

2-Prop Z Interval

Menu: [Interval]-[Two-Prop ZInt]

Description: This command obtains the confidence interval of the difference between the proportions of successes of two populations.

The confidence interval is obtained using the following expressions.

The confidence level is $100(1 - \alpha)\%$.

$$Lower = \frac{x_1}{n_1} - \frac{x_2}{n_2} - Z\left(\frac{\alpha}{2}\right) \sqrt{\frac{\frac{x_1}{n_1}\left(1 - \frac{x_1}{n_1}\right)}{n_1} + \frac{\frac{x_2}{n_2}\left(1 - \frac{x_2}{n_2}\right)}{n_2}} \quad \begin{matrix} n_1, n_2 : \text{sample size} \\ x_1, x_2 : \text{data} \end{matrix}$$

$$Upper = \frac{x_1}{n_1} - \frac{x_2}{n_2} + Z\left(\frac{\alpha}{2}\right) \sqrt{\frac{\frac{x_1}{n_1}\left(1 - \frac{x_1}{n_1}\right)}{n_1} + \frac{\frac{x_2}{n_2}\left(1 - \frac{x_2}{n_2}\right)}{n_2}}$$

Definition of Terms

C-Level: confidence level ($0 \leq \text{C-Level} < 1$)

x_1 : data value (integer, $x_1 \geq 0$) of sample 1

n_1 : size of sample 1 (positive integer)

x_2 : data value (integer, $x_2 \geq 0$) of sample 2

n_2 : size of sample 2 (positive integer)

Calculation Result Output

Lower : interval lower limit (left edge)

Upper : interval upper limit (right edge)

\hat{p}_1 : estimated proportion of sample 1

\hat{p}_2 : estimated proportion of sample 2

n_1 : size of sample 1

n_2 : size of sample 2



Example

Data1 : 49, sample size : 61
 Data2 : 38, sample size : 62
 Significance level : 5% (= confidence level : 95%)

• **Statistics Wizard Operation**

- (1) On the menu bar, tap [Calc] and then [Interval].
- (2) Select [Two-Prop ZInt] and then tap [Next >>].
- (3) Input values.
- (4) Tap [Next >>].

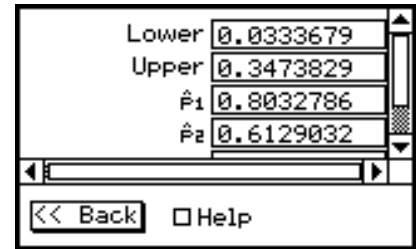
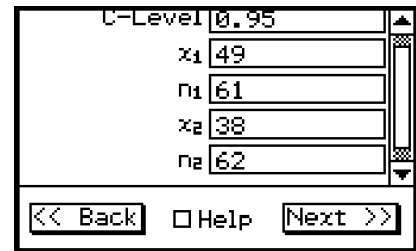

• **Program, eActivity or Main Application**

Command: TwoPropZInt□

Command Syntax

C-Level value, x_1 value, n_1 value, x_2 value, n_2 value

Input Example:

TwoPropZInt 0.95,49,61,38,62

■ **t Confidence Interval**

1-Sample t Interval

Menu: [Interval]-[One-Sample TInt]

Description: This command obtains the confidence interval for the population mean when the population standard deviation is unknown.

The confidence interval is obtained using the following expressions.
 The confidence level is 100 (1 - α)%.

$$Lower = \bar{x} - t_{n-1} \left(\frac{\alpha}{2} \right) \frac{S_x}{\sqrt{n}}$$

$$Upper = \bar{x} + t_{n-1} \left(\frac{\alpha}{2} \right) \frac{S_x}{\sqrt{n}}$$

Definition of Terms

- C-Level : confidence level ($0 \leq \text{C-Level} < 1$)
- List : list where sample data is located
- Freq : frequency of sample (1 or list name)
- \bar{x} : sample mean
- S_x : sample standard deviation ($S_x \geq 0$)
- n : sample size (positive integer)



Calculation Result Output

Lower : interval lower limit (left edge)
 Upper : interval upper limit (right edge)
 \bar{x} : sample mean
 s_x : sample standard deviation
 n : sample size

Example

list1 : { 1.6, 1.7, 1.8, 1.9 }
 Significance level : 5% (= confidence level : 95%)

• Statistics Wizard Operation

- (1) Input the data into [list1] in the Stat Editor.
- (2) On the menu bar, tap [Calc] and then [Interval].
- (3) Select [One-Sample TInt] and then tap [Next >>].
- (4) Input value.
- (5) Select List [list1] and Freq [1].
- (6) Tap [Next >>].

C-Level 0.95
 List list1
 Freq 1
 << Back Help Next >>

Lower 1.544574
 Upper 1.955426
 \bar{x} 1.75
 s_x 0.1290994
 n 4
 << Back Help

• Program, eActivity or Main Application

Command: OneSampleTInt□

Command Syntax

Syntax 1 (list format)

C-Level value, List, Freq (or 1)
 * "Freq" can be omitted. Doing so sets "1" for "Freq".

Syntax 2 (parameter format)

C-Level value, \bar{x} value, s_x value, n value

Input Example:

Syntax 1 (list format)

OneSampleTInt 0.95,list1,1

Syntax 2 (parameter format)

OneSampleTInt 0.95,66.3,8.4,12

2-Sample t Interval

Menu: [Interval]-[Two-Sample TInt]

Description: This command obtains the confidence interval for the difference between two population means when the population standard deviations are unknown.

The confidence interval is obtained using the following expressions.
 The confidence level is $100(1 - \alpha)\%$.

When the two population standard deviations are equal (pooled)

$$\text{Lower} = (\bar{x}_1 - \bar{x}_2) - t_{n_1+n_2-2} \left(\frac{\alpha}{2} \right) \sqrt{Sp^2 \left(\frac{1}{n_1} + \frac{1}{n_2} \right)}$$

$$\text{Upper} = (\bar{x}_1 - \bar{x}_2) + t_{n_1+n_2-2} \left(\frac{\alpha}{2} \right) \sqrt{Sp^2 \left(\frac{1}{n_1} + \frac{1}{n_2} \right)}$$

When the two population standard deviations are not equal (not pooled)

$$\text{Lower} = (\bar{x}_1 - \bar{x}_2) - t_{df} \left(\frac{\alpha}{2} \right) \sqrt{\left(\frac{S_{x1}^2}{n_1} + \frac{S_{x2}^2}{n_2} \right)}$$

$$\text{Upper} = (\bar{x}_1 - \bar{x}_2) + t_{df} \left(\frac{\alpha}{2} \right) \sqrt{\left(\frac{S_{x1}^2}{n_1} + \frac{S_{x2}^2}{n_2} \right)}$$

$$df = \frac{1}{\frac{C^2}{n_1-1} + \frac{(1-C)^2}{n_2-1}}$$

$$C = \frac{\frac{S_{x1}^2}{n_1}}{\left(\frac{S_{x1}^2}{n_1} + \frac{S_{x2}^2}{n_2} \right)}$$

Definition of Terms

- C-Level : confidence level ($0 \leq \text{C-Level} < 1$)
- List(1) : list where sample 1 data is located
- List(2) : list where sample 2 data is located
- Freq(1) : frequency of sample 1 (1 or list name)
- Freq(2) : frequency of sample 2 (1 or list name)
- Pooled : On or Off
- \bar{x}_1 : sample mean of sample 1 data
- s_{x1} : sample standard deviation of sample 1 ($s_{x1} \geq 0$)
- n_1 : size of sample 1 (positive integer)
- \bar{x}_2 : sample mean of sample 2 data
- s_{x2} : sample standard deviation of sample 2 ($s_{x2} \geq 0$)
- n_2 : size of sample 2 (positive integer)

Calculation Result Output

- Lower : interval lower limit (left edge)
- Upper : interval upper limit (right edge)
- df : degrees of freedom
- \bar{x}_1 : sample mean of sample 1 data
- \bar{x}_2 : sample mean of sample 2 data
- s_{x1} : sample standard deviation of sample 1
- s_{x2} : sample standard deviation of sample 2
- s_p : pooled sample standard deviation (Displayed only when pooling is turned on.)
- n_1 : size of sample 1
- n_2 : size of sample 2



Example

list1 : { 12.207, 16.869, 25.05, 22,429, 8.456, 10.589 }
 list2 : { 11.074, 9.686, 12.064, 9.351, 8.182, 6.642 }
 Significance level : 5% (= confidence level : 95%)

• Statistics Wizard Operation

- (1) Input the data into [list1] and [list2] in the Stat Editor.
- (2) On the menu bar, tap [Calc] and then [Interval].
- (3) Select [Two-Sample TInt] and then tap [Next >>].
- (4) Input value.
- (5) Select List(1) [list1], List(2) [list2], Freq(1) [1], Freq(2) [1] and Pooled [Off].
- (6) Tap [Next >>].

	list1	list2	list3
1	12.207	11.074	
2	16.869	9.686	
3	25.05	12.064	
4	22.429	9.351	
5	8.456	8.182	

Calc [] =

C-Level
 List(1)
 List(2)
 Freq(1)
 Freq(2)
 Pooled
 Help

Lower
 Upper
 df
 \bar{x}_1
 Help

•Program, eActivity or Main Application

Command: TwoSampleTInt□

Command Syntax

Syntax 1 (list format)

C-Level value, List(1), List(2), Freq(1) (or 1), Freq(2) (or 1), Pooled condition (On or Off)
 * "Freq" can be omitted. Doing so sets "1" for "Freq".
 * "Pooled" can be omitted. Doing so sets "Off" for "Pooled".

Syntax 2 (parameter format)

C-Level value, \bar{x}_1 value, s_{x1} value, n_1 value, \bar{x}_2 value, s_{x2} value, n_2 value, Pooled condition (On or Off)
 * "Pooled" can be omitted. Doing so sets "Off" for "Pooled".

Input Example:

Syntax 1 (list format)

TwoSampleTInt 0.95,list1,list2,1,1,Off

Syntax 2 (parameter format)

TwoSampleTInt 0.95,80.4,2.07,30,84.2,1.96,35,On

7-11 Distributions

Though there are a number of different types of distributions, the one most commonly used is the “Normal Distribution”, which is an essential type of distribution for statistical calculations. Other types of distributions include the Poisson distribution and geometric distribution. The type of distribution used depends on the type of data being handled.

The shape of a distribution makes it possible to determine trends in data somewhat. You can specify a value and calculate the probability that any data value from the distribution is, for example, less than the specified value. In other words, you can determine what percent from the bottom that data value occurs within the distribution.

The following is a list of distributions and the description of what each one calculates.

Distribution Name	Description
Normal Distribution	
Normal Probability Density	Calculates the normal probability density for a specified value.
Normal Cumulative Distribution	Calculates the cumulative probability of a normal distribution between a lower bound and an upper bound.
Inverse Normal Cumulative Distribution	Calculates the boundary value(s) of a normal cumulative probability distribution for specified values.
t Distribution	
Student- t Probability Density	Calculates the Student- t probability density for a specified value.
Student- t Cumulative Distribution	Calculates the cumulative probability of a Student- t distribution between a lower bound and an upper bound.
Inverse Student- t Cumulative Distribution	Calculates the lower bound value of a Student- t cumulative probability distribution for specified values.
χ^2 Distribution	
χ^2 Probability Density	Calculates the χ^2 probability density for a specified value.
χ^2 Cumulative Distribution	Calculates the cumulative probability of a χ^2 distribution between a lower bound and an upper bound.
Inverse χ^2 Cumulative Distribution	Calculates the lower bound value of a χ^2 cumulative probability distribution for specified values.
F Distribution	
F Probability Density	Calculates the F probability density for a specified value.
F Cumulative Distribution	Calculates the cumulative probability of an F distribution between a lower bound and an upper bound.
Inverse F Cumulative Distribution	Calculates the lower bound value of an F cumulative probability distribution for specified values.



7-11-2
Distributions

Distribution Name	Description
Binomial Distribution	
Binomial Distribution Probability	Calculates the probability in a binomial distribution that the success will occur on a specified trial.
Binomial Cumulative Distribution	Calculates the cumulative probability in a binomial distribution that the success will occur on or before a specified trial.
Inverse Binomial Cumulative Distribution	Calculates the minimum number of trials of a binomial cumulative probability distribution for specified values.
Poisson Distribution	
Poisson Distribution Probability	Calculates the probability in a Poisson distribution that the success will occur on a specified trial.
Poisson Cumulative Distribution	Calculates the cumulative probability in a Poisson distribution that the success will occur on or before a specified trial.
Inverse Poisson Cumulative Distribution	Calculates the minimum number of trials of a Poisson cumulative probability distribution for specified values.
Geometric Distribution	
Geometric Distribution Probability	Calculates the probability in a geometric distribution that the success will occur on a specified trial.
Geometric Cumulative Distribution	Calculates the cumulative probability in a geometric distribution that the success will occur on or before a specified trial.
Inverse Geometric Cumulative Distribution	Calculates the minimum number of trials of a geometric cumulative probability distribution for specified values.
Hypergeometric Distribution	
Hypergeometric Distribution Probability	Calculates the probability in a hypergeometric distribution that the success will occur on a specified trial.
Hypergeometric Cumulative Distribution	Calculates the cumulative probability in a hypergeometric distribution that the success will occur on or before a specified trial.
Inverse Hypergeometric Cumulative Distribution	Calculates the minimum number of trials of a hypergeometric cumulative probability distribution for specified values.



Distribution Command List

Important!

Though list data can be used within the argument of the Distribution function (page 2-8-48), list data cannot be used in the argument of the Statistics Wizard operations described here or in operations that use the Distribution command in the applications.

For details about using list data within the Distribution function, see “Specifying Arguments within the Distribution Function” (page 2-8-48).

Normal Distribution

Normal Probability Density

Menu: [Distribution]-[Normal PD]

Description: This command calculates the probability density of normal distribution from a specified x value. Normal probability density is used for normal distribution.

$$f(x) = \frac{1}{\sqrt{2\pi}\sigma} e^{-\frac{(x-\mu)^2}{2\sigma^2}} \quad (\sigma > 0)$$

Definition of Terms

- x : data value
- σ : population standard deviation ($\sigma > 0$)
- μ : population mean

Specifying $\sigma = 1$ and $\mu = 0$ produces standard normal distribution.

Calculation Result Output

prob : normal probability density

Example

Data : 37.5
Population standard deviation : 2
Population mean : 35

• Statistics Wizard Operation

- (1) On the menu bar, tap [Calc] and then [Distribution].
- (2) Select [Normal PD] and then tap [Next >>].
- (3) Input values.
- (4) Tap [Next >>].
- (5) To display the graph, tap .

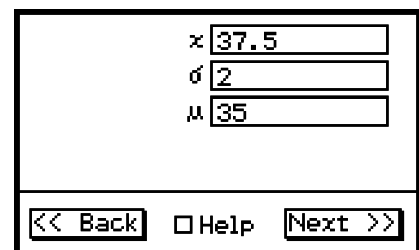
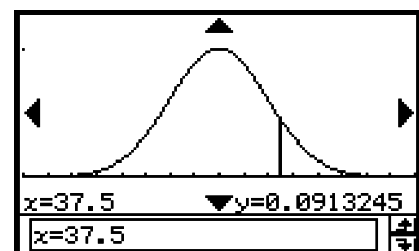
•Program, eActivity or Main Application

Command: NormPD□

Command Syntax

x value, *σ* value, *μ* value

Input Example:

NormPD 37.5,2,35

Normal Cumulative Distribution

Menu: [Distribution]-[Normal CD]

Description: This command calculates the probability of normal distribution data falling between *a* and *b*.

$$p = \frac{1}{\sqrt{2\pi}\sigma} \int_a^b e^{-\frac{(x-\mu)^2}{2\sigma^2}} dx$$

a : lower bound (Lower)
b : upper bound (Upper)

Definition of Terms

- Lower : lower bound
- Upper : upper bound
- σ* : population standard deviation (*σ* > 0)
- μ* : population mean

Calculation Result Output

- prob* : normal distribution probability *p*
- z* Low : standardized lower limit *z* value
- z* Up : standardized upper limit *z* value

Example

Upper bound : 36 (lower bound : $-\infty$)
Population standard deviation : 2
Population mean : 35

• Statistics Wizard Operation

- (1) On the menu bar, tap [Calc] and then [Distribution].
- (2) Select [Normal CD] and then tap [Next >>].
- (3) Input values.
- (4) Tap [Next >>].
- (5) To display the graph, tap .

Lower	<input type="text" value="-∞"/>
Upper	<input type="text" value="36"/>
<i>σ</i>	<input type="text" value="2"/>
<i>μ</i>	<input type="text" value="35"/>
<input type="button" value="◀ Back"/> <input type="button" value="□ Help"/> <input type="button" value="Next >>"/>	

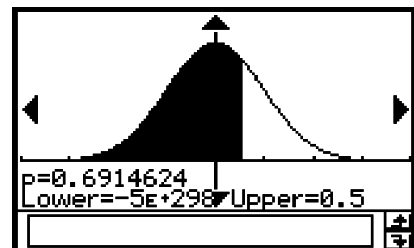

•Program, eActivity or Main Application

Command: NormCD□

Command Syntax

Lower value, Upper value, σ value, μ value

Input Example:

NormCD $-\infty,36,2,35$

Inverse Normal Cumulative Distribution

Menu: [Inv. Distribution]-[Inverse Normal CD]

Description: This command calculates the cumulative probability in a normal distribution based on lower and upper bounds.

This command returns the upper and lower bound of integration values that satisfy the equations below.

Tail:Left

$$\int_{-\infty}^{\alpha} f(x)dx = p$$

Upper bound α is returned.

Tail:Right

$$\int_{\alpha}^{+\infty} f(x)dx = p$$

Lower bound α is returned.

Tail:Center

$$\int_{\alpha}^{\beta} f(x)dx = p$$

Lower bound α and upper bound β are returned.

$$\left(\mu = \frac{\alpha + \beta}{2}\right)$$

Definition of Terms

Tail setting: probability value tail specification (L (Left), R (Right), C (Center))

Area : probability value ($0 \leq \text{Area} \leq 1$)

σ : population standard deviation ($\sigma > 0$)

μ : population mean

Calculation Result Output

inverse cumulative normal distribution

x_1 InvN: Upper bound when Tail:Left

Lower bound when Tail:Right or Tail:Center

x_2 InvN: Upper bound when Tail:Center

Example

Tail : Left

Probability : 0.7

Population standard deviation : 2

Population mean : 35

• **Statistics Wizard Operation**

- (1) On the menu bar, tap [Calc] and then [Distribution].
- (2) Select [Inverse Normal CD] and then tap [Next >>].
- (3) Select Tail setting [Left] and input values.
- (4) Tap [Next >>].
- (5) To display the graph, tap .

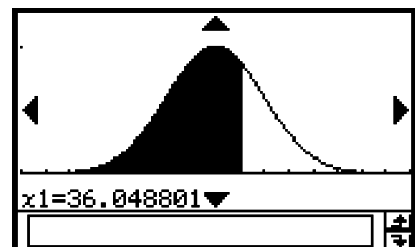
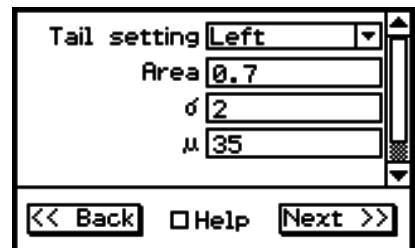

• **Program, eActivity or Main Application**

Command: InvNormCD or InvNorm

Command Syntax

“Tail setting”, Area value, σ value, μ value

Input Example:

InvNorm “L”,0.7,2,35

■ **t Distribution**

Student-t Probability Density

Menu: [Distribution]-[Student-T PD]

Description: This command calculates t probability density from a specified x value.

$$f(x) = \frac{\Gamma\left(\frac{df+1}{2}\right)\left(1+\frac{x^2}{df}\right)^{-\frac{df+1}{2}}}{\Gamma\left(\frac{df}{2}\right)\sqrt{\pi \cdot df}}$$

Definition of Terms

x : data value
 df : degrees of freedom ($df > 0$)

Calculation Result Output

prob : Student- t probability density

Example

Data : 2
Degrees of freedom : 5

• **Statistics Wizard Operation**

- (1) On the menu bar, tap [Calc] and then [Distribution].
- (2) Select [Student-T PD] and then tap [Next >>].
- (3) Input values.
- (4) Tap [Next >>].
- (5) To display the graph, tap .

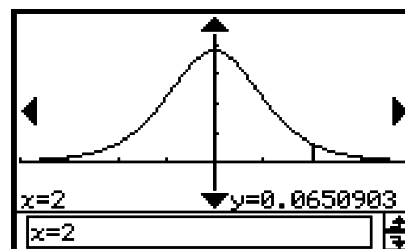
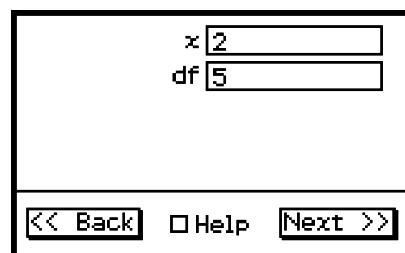

•Program, eActivity or Main Application

Command: TPD□

Command Syntax

x value, df value

Input Example:

TPD 2,5

Student- t Cumulative Distribution

Menu: [Distribution]-[Student-T CD]

Description: This command calculates the probability of the Student- t distribution data falling between a and b .

$$p = \frac{\Gamma\left(\frac{df+1}{2}\right)}{\Gamma\left(\frac{df}{2}\right)\sqrt{\pi \cdot df}} \int_a^b \left(1 + \frac{x^2}{df}\right)^{-\frac{df+1}{2}} dx$$

a : lower bound (Lower)
 b : upper bound (Upper)

Definition of Terms

- Lower : lower bound
- Upper : upper bound
- df : degrees of freedom ($df > 0$)

Calculation Result Output

- $prob$: Student- t distribution probability p
- t Low : lower bound value you input
- t Up : upper bound value you input

Example

Lower bound : 1.5 (upper bound : ∞)
Degrees of freedom : 18

• **Statistics Wizard Operation**

- (1) On the menu bar, tap [Calc] and then [Distribution].
- (2) Select [Student-T CD] and then tap [Next >>].
- (3) Input values.
- (4) Tap [Next >>].
- (5) To display the graph, tap .

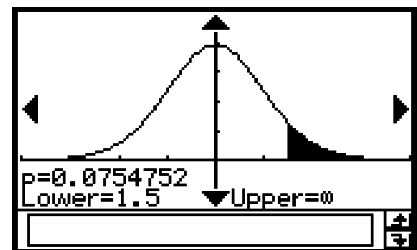
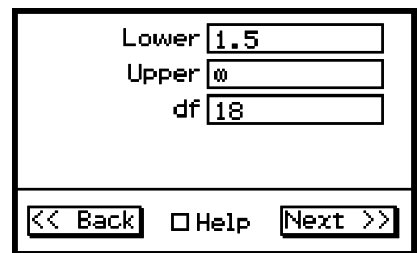

•Program, eActivity or Main Application

Command: TCD□

Command Syntax

Lower value, Upper value, *df* value

Input Example:

TCD 1.5,∞,18

Inverse Student-*t* Cumulative Distribution

Menu: [Inv. Distribution]-[Inverse T CD]

Description: This command calculates the inverse of the *t* cumulative distribution.

$$\int_{\alpha}^{+\infty} f(x) = p$$

This command returns the lower bound of integration value α that satisfies the equation above.

Definition of Terms

prob : *t* cumulative probability ($p, 0 \leq p \leq 1$)

df : degrees of freedom ($df > 0$)

Calculation Result Output

xInv : inverse *t* cumulative distribution

Example

Probability : 0.0754752
Degrees of freedom : 18

• **Statistics Wizard Operation**

- (1) On the menu bar, tap [Calc] and then [Distribution].
- (2) Select [Inverse T CD] and then tap [Next >>].
- (3) Input values.
- (4) Tap [Next >>].

prob
df

<< Back □ Help Next >>

xInv

<< Back □ Help

•Program, eActivity or Main Application

Command: InvTCD□

Command Syntax

prob value, *df* value

Input Example:

InvTCD 0.0754752,18



■ χ^2 Distribution

χ^2 Probability Density

Menu: [Distribution]-[χ^2 PD]

Description: This command calculates the probability density of χ^2 distribution from a specified x value.

$$f(x) = \frac{1}{\Gamma\left(\frac{df}{2}\right)} \left(\frac{1}{2}\right)^{\frac{df}{2}} x^{\frac{df}{2}-1} e^{-\frac{x}{2}}$$

Definition of Terms

x : data value

df : degrees of freedom (positive integer)

Calculation Result Output

$prob$: χ^2 probability density

Example

Data : 2

Degrees of freedom : 4

• Statistics Wizard Operation

- (1) On the menu bar, tap [Calc] and then [Distribution].
- (2) Select [χ^2 PD] and then tap [Next >>].
- (3) Input values.
- (4) Tap [Next >>].
- (5) To display the graph, tap .

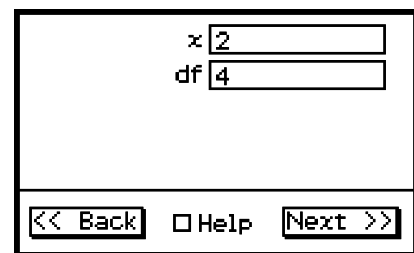
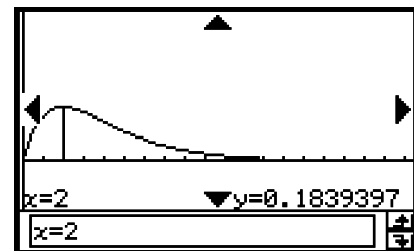
• Program, eActivity or Main Application

Command: ChiPD□

Command Syntax

x value, df value

Input Example:

ChiPD 2,4

χ^2 Cumulative Distribution

Menu: [Distribution]-[χ^2 CD]

Description: This command calculates the probability of χ^2 distribution data falling between a and b .

$$p = \frac{1}{\Gamma\left(\frac{df}{2}\right)} \left(\frac{1}{2}\right)^{\frac{df}{2}} \int_a^b x^{\frac{df}{2}-1} e^{-\frac{x}{2}} dx$$

a : lower bound (Lower)
 b : upper bound (Upper)

Definition of Terms

Lower : lower bound
Upper : upper bound
 df : degrees of freedom (positive integer)

Calculation Result Output

$prob$: χ^2 distribution probability p

Example

Lower bound : 2.7 (upper bound : ∞)
Degrees of freedom : 4

• Statistics Wizard Operation

- (1) On the menu bar, tap [Calc] and then [Distribution].
- (2) Select [χ^2 CD] and then tap [Next >>].
- (3) Input values.
- (4) Tap [Next >>].
- (5) To display the graph, tap .

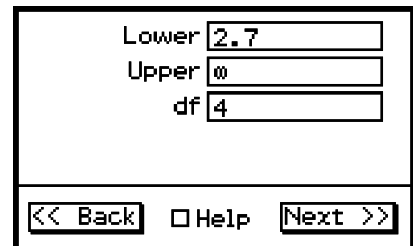
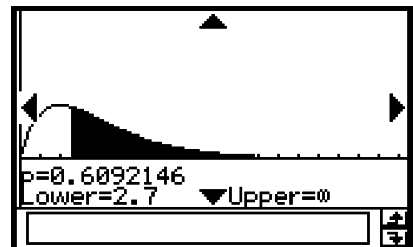
• Program, eActivity or Main Application

Command: ChiCD

Command Syntax

Lower value, Upper value, df value

Input Example:

ChiCD 2.7, ∞ ,4

Inverse χ^2 Cumulative Distribution

Menu: [Inv. Distribution]-[Inverse χ^2 CD]

Description: This command calculates the inverse of the χ^2 cumulative distribution.

$$\int_a^{+\infty} f(x) = p$$

This command returns the lower bound of integration value a that satisfies the equation above.

Definition of Terms

prob : χ^2 cumulative probability (p , $0 \leq p \leq 1$)

df : degrees of freedom (positive integer)

Calculation Result Output

xInv : inverse χ^2 cumulative distribution

Example

Probability : 0.6092146

Degrees of freedom : 4

• Statistics Wizard Operation

- (1) On the menu bar, tap [Calc] and then [Distribution].
- (2) Select [Inverse χ^2 CD] and then tap [Next >>].
- (3) Input values.
- (4) Tap [Next >>].

prob	<input type="text" value="0.6092146"/>
df	<input type="text" value="4"/>
<input type="button" value="◀ Back"/> <input type="button" value="Help"/> <input type="button" value="Next >>"/>	

<i>xInv</i>	<input type="text" value="2.7"/>
<input type="button" value="◀ Back"/> <input type="button" value="Help"/>	

• Program, eActivity or Main Application

Command: InvChiCD□

Command Syntax

prob value, *df* value

Input Example:

InvChiCD 0.6092146,4

■ F Distribution

F Probability Density

Menu: [Distribution]-[F PD]

Description: This command calculates the probability density of F distribution from a specified x value.

$$f(x) = \frac{\Gamma\left(\frac{n+d}{2}\right)}{\Gamma\left(\frac{n}{2}\right)\Gamma\left(\frac{d}{2}\right)} \left(\frac{n}{d}\right)^{\frac{n}{2}} x^{\frac{n}{2}-1} \left(1 + \frac{n \cdot x}{d}\right)^{-\frac{n+d}{2}}$$

Definition of Terms

x : data value

$n:df$: degrees of freedom of numerator (positive integer)

$d:df$: degrees of freedom of denominator (positive integer)

Calculation Result Output

prob : F probability density

Example

Data : 1.5
Degrees of freedom of numerator : 24
Degrees of freedom of denominator : 19

• Statistics Wizard Operation

- (1) On the menu bar, tap [Calc] and then [Distribution].
- (2) Select [F PD] and then tap [Next >>].
- (3) Input values.
- (4) Tap [Next >>].
- (5) To display the graph, tap .

x	1.5
n:df	24
d:df	19
<input type="button" value="Back"/> <input type="button" value="Help"/> <input type="button" value="Next >>"/>	

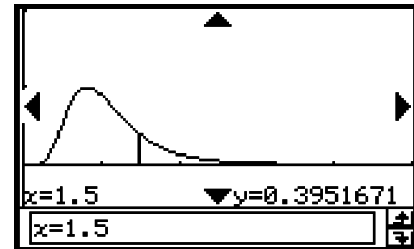

• Program, eActivity or Main Application

Command: FPD

Command Syntax

x value, $n:df$ value, $d:df$ value

Input Example:

FPD 1.5,24,19

F Cumulative Distribution

Menu: [Distribution]-[F CD]

Description: This command calculates the probability of F distribution data falling between a and b .

$$p = \frac{\Gamma\left(\frac{n+d}{2}\right)}{\Gamma\left(\frac{n}{2}\right)\Gamma\left(\frac{d}{2}\right)} \left(\frac{n}{d}\right)^{\frac{n}{2}} \int_a^b x^{\frac{n}{2}-1} \left(1 + \frac{n \cdot x}{d}\right)^{-\frac{n+d}{2}} dx$$

a : lower bound (Lower)
 b : upper bound (Upper)

Definition of Terms

Lower : lower bound
 Upper : upper bound
 $n:df$: degrees of freedom of numerator (positive integer)
 $d:df$: degrees of freedom of denominator (positive integer)

Calculation Result Output

$prob$: F distribution probability p

Example

Lower bound : 1.5 (upper bound : ∞)
 Degrees of freedom of numerator : 24
 Degrees of freedom of denominator : 19

• Statistics Wizard Operation

- (1) On the menu bar, tap [Calc] and then [Distribution].
- (2) Select [F CD] and then tap [Next >>].
- (3) Input values.
- (4) Tap [Next >>].
- (5) To display the graph, tap .

Lower	1.5
Upper	∞
n:df	24
d:df	19
<input type="button" value="Back"/> <input type="button" value="Help"/> <input type="button" value="Next >>"/>	

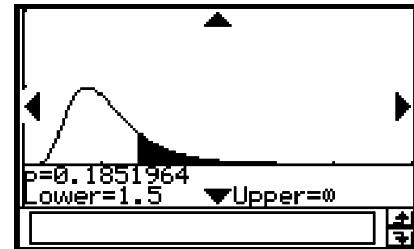

• Program, eActivity or Main Application

Command: FCD

Command Syntax

Lower value, Upper value, *n:df* value, *d:df* value

Input Example:

FCD 1.5, ∞ ,24,19

Inverse *F* Cumulative Distribution

Menu: [Inv. Distribution]-[Inverse F CD]

Description: This command calculates the inverse of the *F* cumulative distribution.

$$\int_{\alpha}^{+\infty} f(x) = p$$

This command returns the lower bound of integration value α that satisfies the equation above.

Definition of Terms

- prob* : *F* cumulative probability ($p, 0 \leq p \leq 1$)
n:df : degrees of freedom of numerator (positive integer)
d:df : degrees of freedom of denominator (positive integer)

Calculation Result Output

xInv : inverse *F* cumulative distribution

Example

Probability : 0.1852
 Degrees of freedom of numerator : 24
 Degrees of freedom of denominator : 19

• Statistics Wizard Operation

- (1) On the menu bar, tap [Calc] and then [Distribution].
- (2) Select [Inverse F CD] and then tap [Next >>].
- (3) Input values.
- (4) Tap [Next >>].

prob	0.1852
n:df	24
d:df	19
<input type="button" value="Back"/> <input type="checkbox"/> Help <input type="button" value="Next >>"/>	

xInv	1.4999911
<input type="button" value="Back"/> <input type="checkbox"/> Help	

• Program, eActivity or Main Application

Command: InvFCD□

Command Syntax

prob value, *n:df* value, *d:df* value

Input Example:

InvFCD 0.1852,24,19

■ Binomial Distribution

Binomial Distribution Probability

Menu: [Distribution]-[Binomial PD]

Description: This command calculates the probability the random variable that follows a binomial distribution will be a given x value. For example, it determines the probability of x successes when the probability of success p -trial is performed n times.

$$f(x) = {}_n C_x p^x (1-p)^{n-x} \quad (x = 0, 1, \dots, n)$$

p : probability of success
($0 \leq p \leq 1$)

n : number of trials

Definition of Terms

x : specified trial (integer from 0 to n)
 Numtrial : number of trials n (integer, $n \geq 0$)
 pos : probability of success p ($0 \leq p \leq 1$)

Calculation Result Output

prob : binomial probability



Example

Trials : 5
Specified trial : 3
Probability of success : 0.63

• **Statistics Wizard Operation**

- (1) On the menu bar, tap [Calc] and then [Distribution].
- (2) Select [Binomial PD] and then tap [Next >>].
- (3) Input values.
- (4) Tap [Next >>].
- (5) To display the graph, tap .

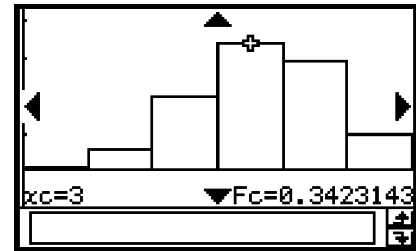
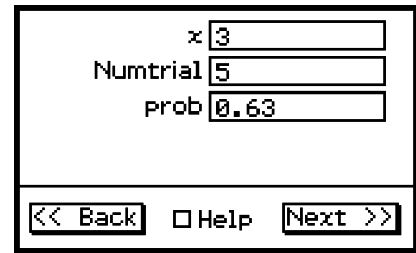

Graphing may take a long time when the absolute value of the argument is large.

• **Program, eActivity or Main Application**

Command: BinomialPD

Command Syntax

x value, Numtrial value, *pos* value

Input Example:

BinomialPD 3,5,0.63

Binomial Cumulative Distribution

Menu: [Distribution]-[Binomial CD]

Description: This command calculates the probability the random variable that follows a binomial distribution will fall between given upper bound and lower bound values. For example, it can be used to determine the probability a test with a success probability of 0.5 (50%) that is performed ten times will be successful at least three times but no more than five times.

Definition of Terms

- Lower : lower bound ($Lower \leq Upper$ integer)
- Upper : upper bound ($Lower \leq Upper$ integer)
- Numtrial : number of trials n (integer, $n \geq 1$)
- pos* : probability of success p ($0 \leq p \leq 1$)

Calculation Result Output

prob : binomial cumulative probability

Example

Trials : 5
Lower bound : 2
Upper bound : 3
Probability of success : 0.63

• **Statistics Wizard Operation**

- (1) On the menu bar, tap [Calc] and then [Distribution].
- (2) Select [Binomial CD] and then tap [Next >>].
- (3) Input values.
- (4) Tap [Next >>].
- (5) To display the graph, tap .

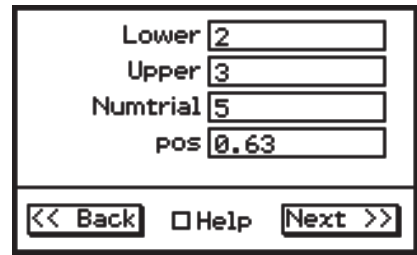
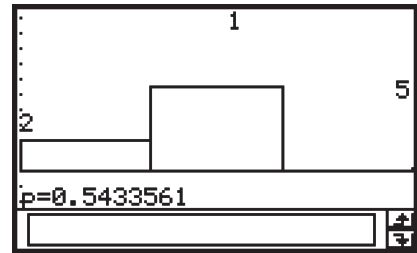
Graphing may take a long time when the absolute value of the argument is large.

• **Program, eActivity or Main Application**

Command: BinomialCD

Command Syntax

Lower value, Upper value, Numtrial value, *pos* value

Input Example:

BinomialCD 2,3,5,0.63

Inverse Binomial Cumulative Distribution

Menu: [Inv. Distribution]-[Inverse Binomial CD]

Description: This command calculates the inverse of the binomial cumulative distribution.

$$\sum_{x=0}^m f(x) \geq prob$$

This command returns the minimum value (positive integer) of *m* (Σ upper bound) that satisfies the inequality formula above.

Definition of Terms

- prob* : binomial cumulative probability ($0 \leq prob \leq 1$)
- Numtrial : number of trials *n* (integer, $n \geq 0$)
- pos* : probability of success *p* ($0 \leq p \leq 1$)

Calculation Result Output

- xInv* : inverse binomial cumulative distribution
- **xInv* : recalculation value (Displayed only when there may be a possibility of rounding error.)

- To account for possible rounding error, ClassPad additionally obtains the result using the probability that is next lowest for the least significant digit. For example, if the probability is 0.61, ClassPad would recalculate using 0.60. The recalculation result is only shown if it is different from the original one.

Example

Binomial cumulative probability : 0.61
Trials : 5
Probability of success : 0.63

• **Statistics Wizard Operation**

- (1) On the menu bar, tap [Calc] and then [Distribution].
- (2) Select [Inverse Binomial CD] and then tap [Next >>].
- (3) Input values.
- (4) Tap [Next >>].

prob	<input type="text" value="0.61"/>
Numtrial	<input type="text" value="5"/>
pos	<input type="text" value="0.63"/>
<input type="button" value="◀ Back"/> <input type="checkbox"/> Help <input type="button" value="Next >>"/>	

prob	<input type="text" value="0.61"/>
xInv	<input type="text" value="4"/>

prob-0.01	
*xInv	<input type="text" value="3"/>
<input type="button" value="◀ Back"/> <input type="checkbox"/> Help	

• **Program, eActivity or Main Application**

Command: InvBinomialCD□

Command Syntax

prob value, *Numtrial* value, *pos* value

Input Example:

InvBinomialCD 0.609,5,0.63

■ **Poisson Distribution**

Poisson Distribution Probability

Menu: [Distribution]-[Poisson PD]

Description: This command calculates the probability the random variable that follows a Poisson distribution will be a given *x* value.

$$f(x) = \frac{e^{-\lambda} \lambda^x}{x!} \quad (x = 0, 1, 2, \dots) \quad \lambda: \text{mean } (\lambda > 0)$$

Definition of Terms

- x* : specified trial (integer, $x \geq 0$)
- λ : mean ($\lambda > 0$)

Calculation Result Output

prob : Poisson probability



Example

Specified trial : 10
Mean : 6

• Statistics Wizard Operation

- (1) On the menu bar, tap [Calc] and then [Distribution].
- (2) Select [Poisson PD] and then tap [Next >>].
- (3) Input values.
- (4) Tap [Next >>].
- (5) To display the graph, tap .

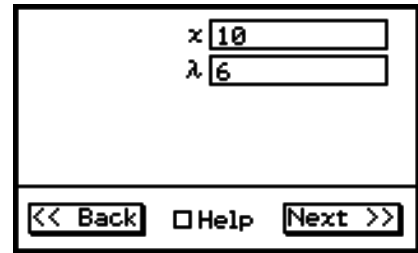
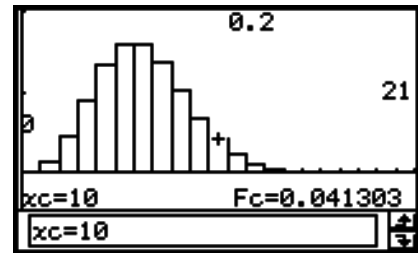
Graphing may take a long time when the absolute value of the argument is large.

• Program, eActivity or Main Application

Command: PoissonPD

Command Syntax

x value, λ value

Input Example:

PoissonPD 10,6

Poisson Cumulative Distribution

Menu: [Distribution]-[Poisson CD]

Description: This command calculates the probability the random variable that follows a Poisson distribution will fall between given upper bound and lower bound values.

Definition of Terms

Lower : lower bound ($\text{Lower} \leq \text{Upper integer}$)
Upper : upper bound ($\text{Lower} \leq \text{Upper integer}$)
 λ : mean ($\lambda > 0$)

Calculation Result Output

prob : Poisson cumulative probability

Example

Lower bound : 2
Upper bound : 3
Mean : 2.26

• Statistics Wizard Operation

- (1) On the menu bar, tap [Calc] and then [Distribution].
- (2) Select [Poisson CD] and then tap [Next >>].
- (3) Input values.
- (4) Tap [Next >>].
- (5) To display the graph, tap .

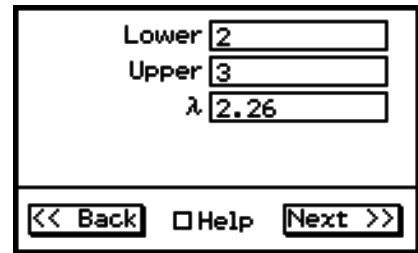
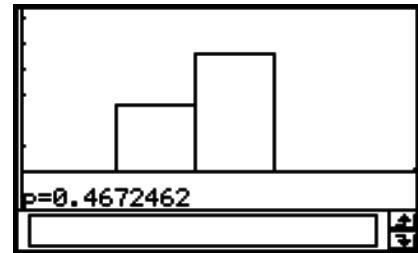
Graphing may take a long time when the absolute value of the argument is large.

• Program, eActivity or Main Application

Command: PoissonCD

Command Syntax

Lower value, Upper value, λ value

Input Example:

PoissonCD 2,3,2.26

Inverse Poisson Cumulative Distribution

Menu: [Inv. Distribution]-[Inverse Poisson CD]

Description: This command calculates the inverse of the Poisson cumulative distribution.

$$\sum_{x=0}^m f(x) \geq prob$$

This command returns the minimum value (positive integer) of m (Σ upper bound) that satisfies the inequality formula above.

Definition of Terms

$prob$: Poisson cumulative probability ($0 \leq prob \leq 1$)
 λ : mean ($\lambda > 0$)

Calculation Result Output

$xInv$: inverse Poisson cumulative distribution
 $*xInv$: recalculation value (Displayed only when there may be a possibility of rounding error.)

- To account for possible rounding error, ClassPad additionally obtains the result using the probability that is next lowest for the least significant digit. For example, if the probability is 0.99999, ClassPad would recalculate using 0.99998. The recalculation result is only shown if it is different from the original one.

Example

Poisson cumulative probability : 0.8074
Mean : 2.26

• **Statistics Wizard Operation**

- (1) On the menu bar, tap [Calc] and then [Distribution].
- (2) Select [Inverse Poisson CD] and then tap [Next >>].
- (3) Input values.
- (4) Tap [Next >>].

prob	0.8074
λ	2.26
<input type="button" value="Back"/> <input type="button" value="Help"/> <input type="button" value="Next >>"/>	

prob	0.8074
xInv	3
<input type="button" value="Back"/> <input type="button" value="Help"/>	

• **Program, eActivity or Main Application**

Command: InvPoissonCD

Command Syntax

prob value, λ value

Input Example:

InvPoissonCD 0.8074,2.26

■ **Geometric Distribution**

Geometric Distribution Probability

Menu: [Distribution]-[Geometric PD]

Description: This command calculates the probability the random variable that follows a geometric distribution will be a given x value.

$$f(x) = p(1-p)^{x-1} \quad (x = 1, 2, 3, \dots) \quad p : \text{probability of success} \quad (0 \leq p \leq 1)$$

Definition of Terms

- x : specified trial (positive integer)
- pos : probability of success p ($0 \leq p \leq 1$)

Calculation Result Output

prob : geometric probability



Example

Specified trial : 6
Probability of success : 0.4

• Statistics Wizard Operation

- (1) On the menu bar, tap [Calc] and then [Distribution].
- (2) Select [Geometric PD] and then tap [Next >>].
- (3) Input values.
- (4) Tap [Next >>].
- (5) To display the graph, tap .

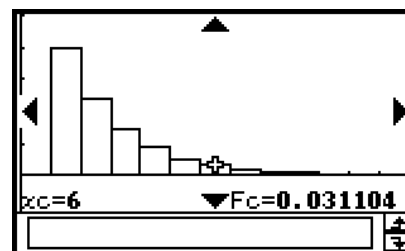
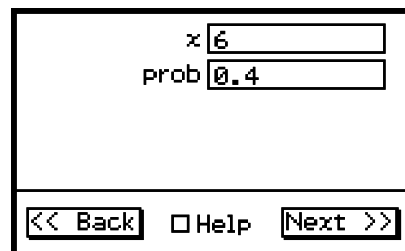

Graphing may take a long time when the absolute value of the argument is large.

• Program, eActivity or Main Application

Command: GeoPD 

Command Syntax

x value, *pos* value

Input Example:

GeoPD 6,0.4

Geometric Cumulative Distribution

Menu: [Distribution]-[Geometric CD]

Description: This command calculates the probability the random variable that follows a geometric distribution will fall between given upper bound and lower bound values.

Definition of Terms

Lower : lower bound ($\text{Lower} \leq \text{Upper integer}$)

Upper : upper bound ($\text{Lower} \leq \text{Upper integer}$)

pos : probability of success p ($0 \leq p \leq 1$)

Calculation Result Output

prob : geometric cumulative probability

Example

Lower bound : 2
Upper bound : 3
Probability of success : 0.5

• **Statistics Wizard Operation**

- (1) On the menu bar, tap [Calc] and then [Distribution].
- (2) Select [Geometric CD] and then tap [Next >>].
- (3) Input values.
- (4) Tap [Next >>].
- (5) To display the graph, tap .

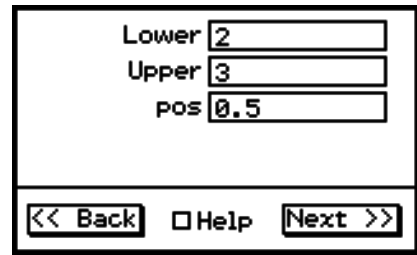
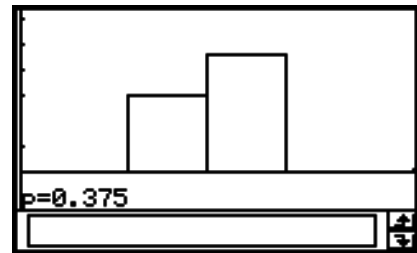
Graphing may take a long time when the absolute value of the argument is large.

• **Program, eActivity or Main Application**

Command: GeoCD

Command Syntax

Lower value, Upper value, *pos* value

Input Example:

GeoCD 2,3,0.5

Inverse Geometric Cumulative Distribution

Menu: [Inv. Distribution]-[Inverse Geo CD]

Description: This command calculates the inverse of the geometric cumulative distribution.

$$\sum_{x=1}^m f(x) \geq prob$$

This command returns the minimum value (positive integer) of *m* (Σ upper bound) that satisfies the inequality formula above.

Definition of Terms

prob : geometric cumulative probability ($0 \leq prob \leq 1$)

pos : probability of success *p* ($0 \leq p \leq 1$)

Calculation Result Output

xInv : inverse geometric cumulative distribution

**xInv* : recalculation value (Displayed only when there may be a possibility of rounding error.)

- To account for possible rounding error, ClassPad additionally obtains the result using the probability that is next lowest for the least significant digit. For example, if the probability is 0.875, ClassPad would recalculate using 0.874. The recalculation result is only shown if it is different from the original one.

Example

Geometric cumulative probability : 0.875
Probability of success : 0.5

• Statistics Wizard Operation

- (1) On the menu bar, tap [Calc] and then [Distribution].
- (2) Select [Inverse Geo CD] and then tap [Next >>].
- (3) Input values.
- (4) Tap [Next >>].

prob	<input type="text" value="0.875"/>
pos	<input type="text" value="0.5"/>
<input type="button" value="◀ Back"/> <input type="button" value="Help"/> <input type="button" value="Next >>"/>	

prob	<input type="text" value="0.875"/>
xInv	<input type="text" value="3"/>
<input type="button" value="◀ Back"/> <input type="button" value="Help"/>	

• Program, eActivity or Main Application

Command: InvGeoCD

Command Syntax

prob value, *pos* value

Input Example:

InvGeoCD 0.875,0.5

■ Hypergeometric Distribution

Hypergeometric Distribution Probability

Menu: [Distribution]-[Hypergeometric PD]

Description: This command calculates the probability the random variable that follows a hypergeometric distribution will be a given x value.

$$prob = \frac{{}^M C_x \times {}^{N-M} C_{n-x}}{{}^N C_n}$$

Definition of Terms

- x : specified trial (integer)
- n : number of trials from population ($0 \leq n$ integer)
- M : number of successes in population ($0 \leq M$ integer)
- N : population size ($n \leq N, M \leq N$ integer)

Calculation Result Output

prob : hypergeometric probability



Example

Specified trial: 1
 Number of trials from population: 5
 Number of successes in population: 10
 Population size: 20

• **Statistics Wizard Operation**

- (1) On the menu bar, tap [Calc] and then [Distribution].
- (2) Select [Hypergeometric PD] and then tap [Next >>].
- (3) Input values.
- (4) Tap [Next >>].
- (5) To display the graph, tap .

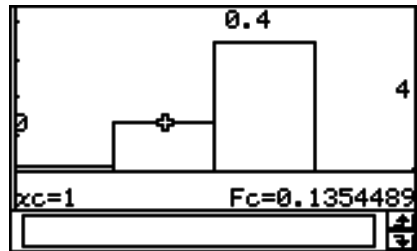
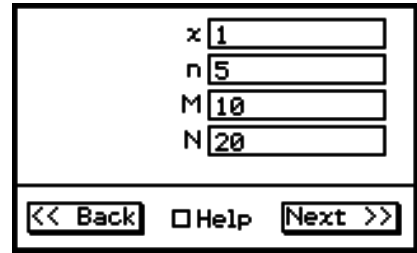

Graphing may take a long time when the absolute value of the argument is large.

• **Program, eActivity or Main Application**

Command: HypergeoPD 

Command Syntax

x value, *n* value, *M* value, *N* value

Input Example:

HypergeoPD 1,5,10,20

Hypergeometric Cumulative Distribution

Menu: [Distribution]-[Hypergeometric CD]

Description: This command calculates the probability the random variable that follows a hypergeometric distribution will fall between given lower bound and upper bound values.

$$prob = \sum_{i=Lower}^{Upper} \frac{{}^M C_i \times {}^{N-M} C_{n-i}}{{}^N C_n}$$

Definition of Terms

- Lower : lower bound (Lower ≤ Upper integer)
- Upper : upper bound (Lower ≤ Upper integer)
- n* : number of trials from population (0 ≤ *n* integer)
- M* : number of successes in population (0 ≤ *M* integer)
- N* : population size (*n* ≤ *N*, *M* ≤ *N* integer)

Calculation Result Output

prob: hypergeometric cumulative probability

Example

Lower bound: 0
 Upper bound: 1
 Number of trials from population: 5
 Number of successes in population: 10
 Population size: 20

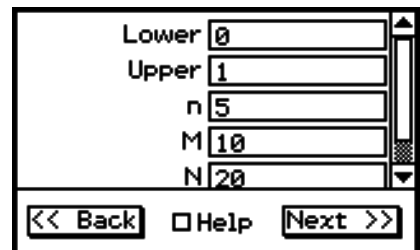

• **Statistics Wizard Operation**

- (1) On the menu bar, tap [Calc] and then [Distribution].
- (2) Select [Hypergeometric CD] and then tap [Next >>].
- (3) Input values.
- (4) Tap [Next >>].
- (5) To display the graph, tap .

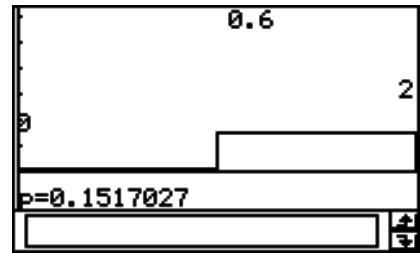

Graphing may take a long time when the absolute value of the argument is large.

• **Program, eActivity or Main Application**

Command: HypergeoCD 

Command Syntax

Lower value, Upper value, *n* value, *M* value, *N* value

Input Example:

HypergeoCD 0,1,5,10,20

Inverse Hypergeometric Cumulative Distribution

Menu: [Inv. Distribution]-[Inverse Hypergeometric]

Description: This command calculates the inverse of the hypergeometric cumulative distribution.

$$prob \leq \sum_{i=0}^x \frac{{}^M C_i \times {}^{N-M} C_{n-i}}{{}^N C_n}$$

This command returns the minimum value (positive integer) of *X* (Σ upper bound) that satisfies the inequality formula above.

Definition of Terms

- prob* : hypergeometric cumulative probability ($0 \leq prob \leq 1$)
- n* : number of trials from population ($0 \leq n$ integer)
- M* : number of successes in population ($0 \leq M$ integer)
- N* : population size ($n \leq N, M \leq N$ integer)

Calculation Result Output

- xInv* : inverse hypergeometric cumulative distribution
- *xInv* : recalculation value (Displayed only when there is the possibility of rounding error.)

- To account for possible rounding error, ClassPad also obtains the result using the probability that is next lowest for the least significant digit. For example, if the probability is 0.3, ClassPad would recalculate using 0.29. The recalculation result is only shown if it is different from the original one.



Example

Hypergeometric cumulative probability: 0.3
Number of trials from population: 5
Number of successes in population: 10
Population size: 20

• Statistics Wizard Operation

- (1) On the menu bar, tap [Calc] and then [Distribution].
- (2) Select [Inverse Hypergeometric] and then tap [Next >>].
- (3) Input values.
- (4) Tap [Next >>].

prob	0.3
n	5
M	10
N	20
<input type="button" value="Back"/> <input type="checkbox"/> Help <input type="button" value="Next >>"/>	

prob	0.3
xInv	2
<input type="button" value="Back"/> <input type="checkbox"/> Help	

• Program, eActivity or Main Application

Command: InvHypergeoCD

Command Syntax

prob value, *n* value, *M* value, *N* value

Input Example:

InvHypergeoCD 0.3,5,10,20



7-12 Statistical System Variables

Performing a statistical calculation, graphing operation, or other operation causes calculation results to be assigned to pre-arranged system variables. For more information, see the “System Variable Table” on page α -7-1.



Chapter 8



Using the Geometry Application

8

The Geometry application allows you to draw and analyze geometric figures. You can draw a triangle and specify values to change the size of its sides so they are 3:4:5, and then check the measurement of each of its angles. Or you can draw a circle and then draw a line that is tangent to a particular point on the circle. The Geometry application also includes an animation feature that lets you watch how a figure changes in accordance with conditions you define.

- 8-1 Geometry Application Overview**
- 8-2 Drawing Figures**
- 8-3 Editing Figures**
- 8-4 Controlling Geometry Window Appearance**
- 8-5 Working with Animations**
- 8-6 Using the Geometry Application with Other Applications**
- 8-7 Managing Geometry Application Files**

8-1 Geometry Application Overview

The Geometry application provides you with the following capabilities.

- The [Draw] menu provides commands for drawing points, lines, polygons, regular polygons, circles, ellipses, and other geometric figures. You can also draw functions. Once drawn, a figure can be moved or edited as required. See “Using the Draw Menu” on page 8-2-1 for more information about this menu.

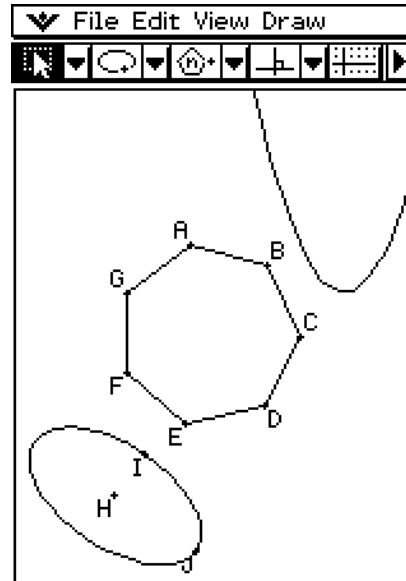
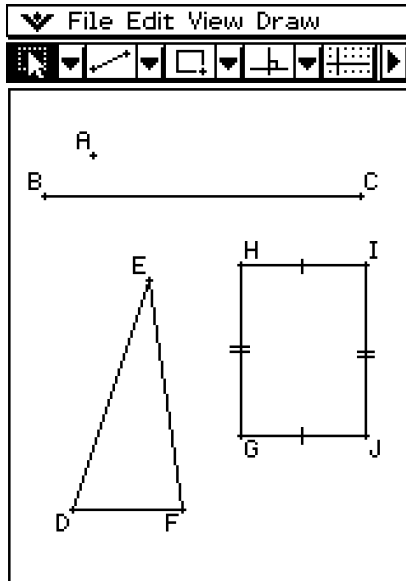

- The [Draw] menu also includes a [Construct] submenu (page 8-2-30) and a [Special Shape] submenu (page 8-2-27). You can use items in the [Construct] submenu to add a midpoint, draw a perpendicular bisector from a given point, create other geometric constructions and even test geometric theorems. The [Special Shape] submenu allows you to draw special figures, such as parallelograms, rectangles, kites and many others.

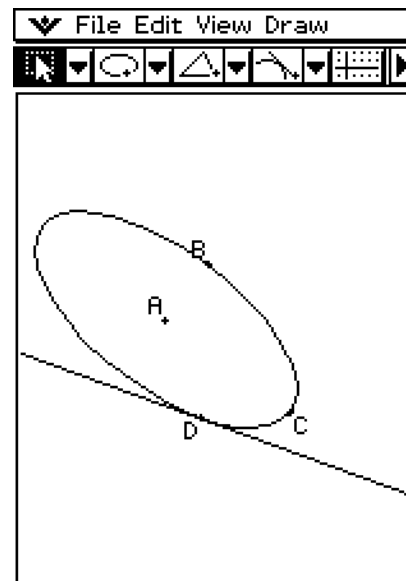
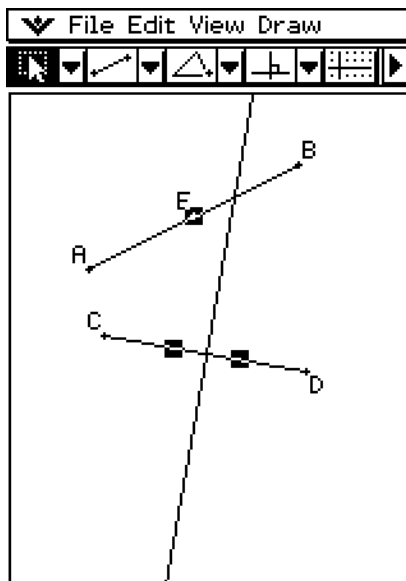

- Tapping the toolbar's right arrow button displays a measurement box. The measurement box displays information for the items that are selected on the window. For example, you can view the coordinates of a point, the length and slope of a line segment, the size of an angle, etc. You can also use the measurement box to change measurements, and to fix measurements so they cannot be changed by other operations.

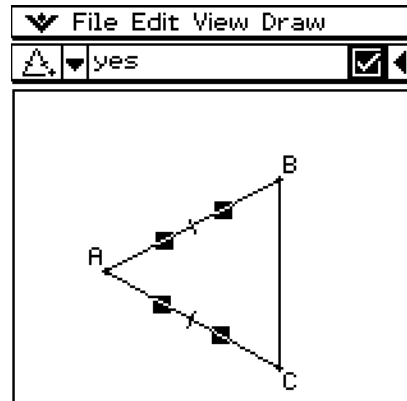
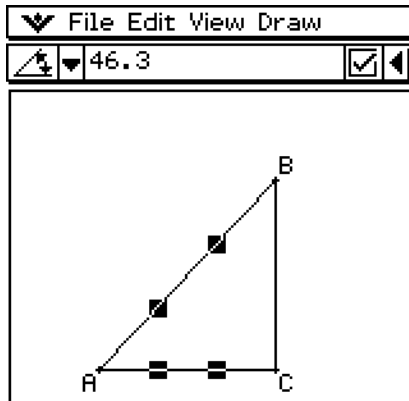

- The Animation feature makes it possible to see how a figure changes when a moving point and its related figures are subjected to certain conditions. A point can move along a line or curve, and can be anywhere along a line segment, the vertex of a triangle, or the center point of a circle.

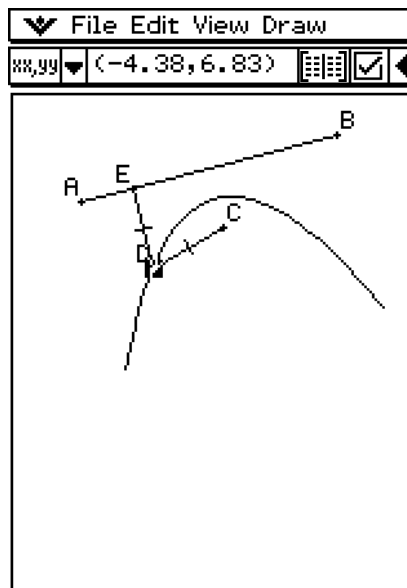
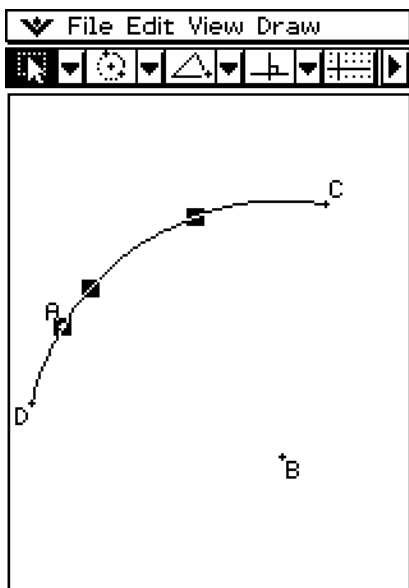

Starting Up the Geometry Application

Use the following procedure to start up the Geometry application.

• ClassPad Operation

On the application menu, tap  Geometry.

This causes a blank Geometry application window to appear.

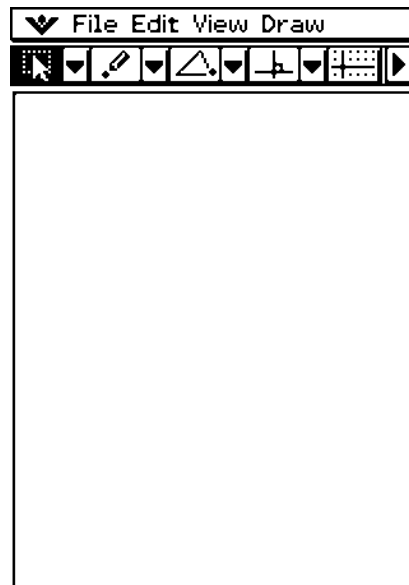

Use this area to draw the figures you want.





Tip

- If you left figures on the Geometry window the last time you exited the Geometry application, those figures will appear the next time you start it up.

Geometry Application Menus and Buttons

This section describes the configuration of the Geometry application windows and provides basic information about its menus and commands.

Tip

-  menu items are the same for all applications. For more information, see “Using the  Menu” on page 1-5-4.
- The View Window ( - [View Window]) and Geometry Format ( - [Geometry Format]) contain settings that are unique to the Geometry application. For details, see “Configuring View Window Settings” on page 8-4-1.

■ File Menu







To do this	Select this File menu item:
Discard the current window contents and create a new file	New
Open an existing file	Open
Save the current window contents to a file	Save

■ Edit Menu

To do this:	Select this Edit menu item:
Undo or redo the last operation	Undo/Redo
Clear all settings fixed with the measurement box	Clear Constraints
Show hidden objects	Show All
Toggle polygon shading on and off	Shade On/Off
Hide the currently selected object	Properties - Hide
Show hidden names	Properties - Show Name
Hide the selected name	Properties - Hide Name
Make the lines of the selected figure thicker	Properties - Thicker
Make the lines of the selected figure thinner	Properties - Thinner
Pin an annotation position on the Geometry window	Properties - Pin
Unpin an annotation on the Geometry window	Properties - Unpin
Specify the number format for each measurement used in the Geometry window	Properties - Number Format
Display the Animate submenu (page 8-5-1)	Animate
Cut the currently selected object and place it onto the clipboard	Cut
Copy the currently selected object and place it onto the clipboard	Copy
Paste the current clipboard contents onto the screen	Paste
Select all objects on the screen	Select All
Delete the currently selected object	Delete
Clear the screen	Clear All



■ View Menu

To do this:	Tap this button:	Or select this View menu item:
Select a segment, line, or part of a figure (page 8-3-1)		Select
Start a box zoom operation		Zoom Box
Activate the pan function for dragging the Graph window with the stylus		Pan
Enlarge the display image		Zoom In
Reduce the size of the display image		Zoom Out
Adjust the size of the display image so it fills the display		Zoom to Fit
Turn display of axes and coordinate values on and off		Toggle Axes
Toggle snapping to the nearest integer coordinate point on and off	—	<input type="checkbox"/> Integer Grid
Turn the Animation toolbar on and off	—	Animation UI

■ Draw Menu

To do this:	Select this Draw menu item:
Draw a figure (page 8-2-1)	Point
	Line Segment
	Infinite Line
	Ray
	Vector
	Circle
	Arc
	Ellipse - Axes
	Ellipse - Foci
	Hyperbola
	Parabola
	Function - $f(x)$
	Function - Polar
	Function - Parametric
Polygon	
Insert a value or text connected with a displayed figure into the display (page 8-2-18)	Text
	Attached Angle
	Measurement
	Expression
Display a submenu for drawing a figure of specially shaped figures (page 8-2-27)	Special Shape
Display a submenu for geometric constructions (page 8-2-30)	Construct





■ Toolbar Button

The operation described below is available from the toolbar only.

To do this:	Do this:
Activate Toggle Select (page 8-3-2)	Tap  and then tap a figure.

Tapping a button highlights it, indicating that the button's function is turned on.

■ About the Measurement Box

Tapping the  button to the right of the toolbar takes you to the measurement box. Tap  to return to the normal toolbar.

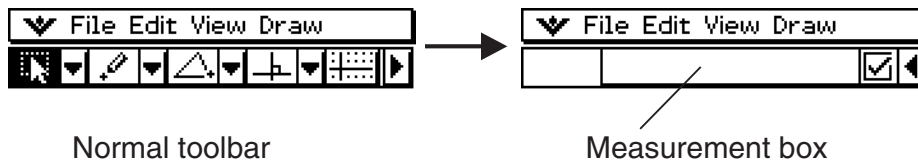

For more information about the measurement box, see “Using the Measurement Box” on page 8-3-6.

■ About the Geometry Format Dialog Box

Settings for the Geometry application can be configured on the Geometry Format dialog box which appears when you tap  and then [Geometry Format]. See “1-9 Configuring Application Format Settings” for more information.

8-2 Drawing Figures

This section explains how to use the Geometry application to draw various types of figures. It also explains how to use the geometric construction tools to investigate theorems and properties in Geometry.

Using the Draw Menu

The [Draw] menu makes it easy to draw a variety of different figures. Each [Draw] menu command is also available on the toolbar.

[Draw] menu commands

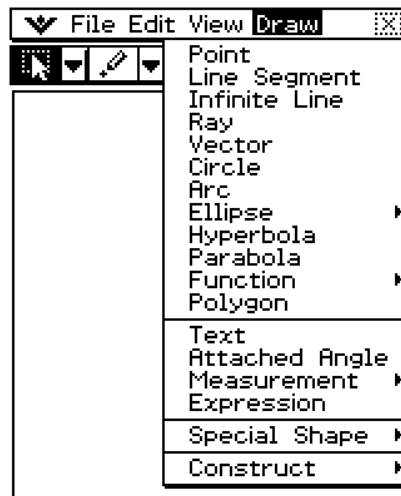

These [Draw] menu commands correspond to the toolbar shown below.

Toolbar

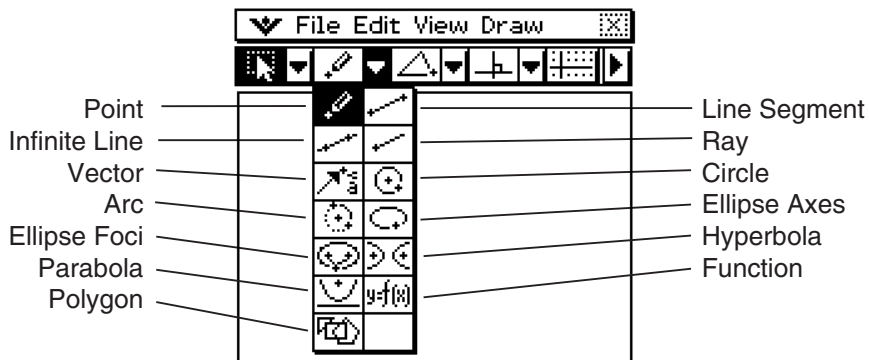

Tip

- Use [Edit] - [Clear All] to clear the screen after experimenting with a draw operation.

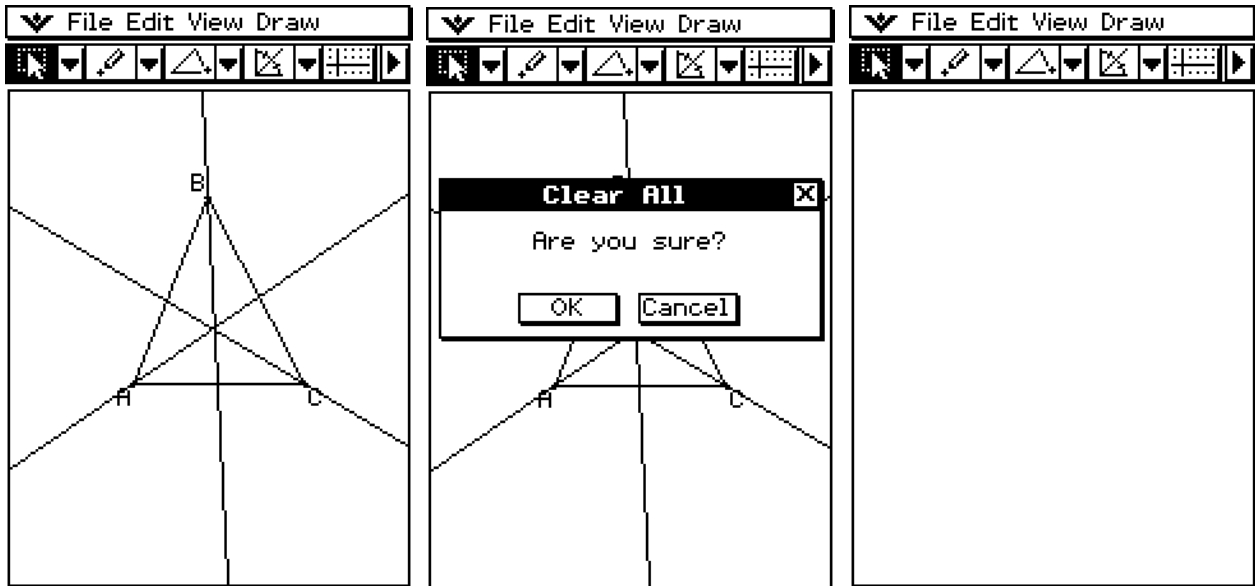

- **To draw a line segment using the menu command**

- (1) Tap [Draw] and then [Line Segment].
 - This highlights the line segment button on the toolbar.
- (2) Tap the screen where you want the line segment to begin, and a point will be drawn, and then tap the point where you want it to end.

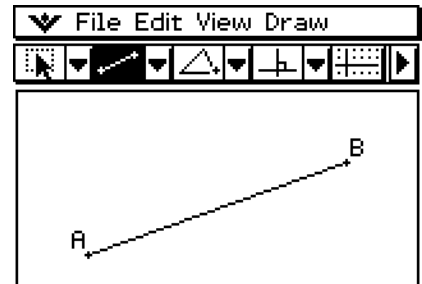

• **To draw a line segment using the toolbar**

- (1) Tap the second down arrow on the toolbar. This opens the [Draw] menu's icon palette.
- (2) Tap the line segment button on the toolbar to highlight it.
- (3) Tap the screen where you want the line segment to begin. This plots a point.
- (4) Tap the beginning point again and, without lifting the stylus, drag to draw the line.
Or you could just tap the ending point.
- (5) When the line segment is the way you want, remove the stylus from the screen.

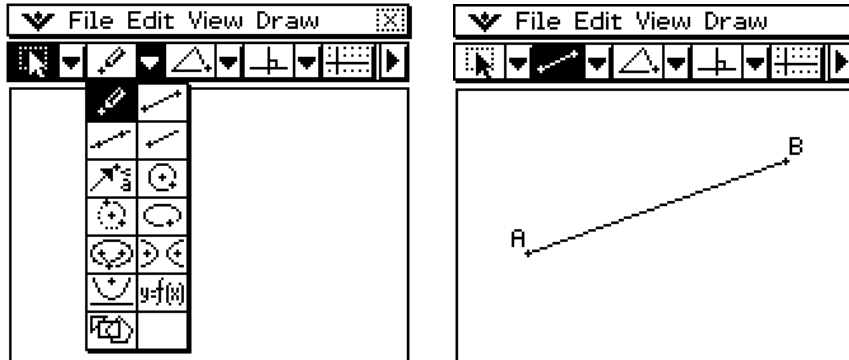

• **To plot a point**

- (1) Tap [Draw] and then [Point].
 - This highlights the point button on the toolbar.
- (2) Tap the location on the screen where you want to plot a point.
 - This plots the point.

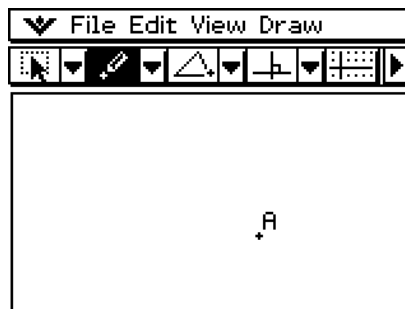

• **To add a labeled point to an existing line**

You can use the following procedure to add a labeled point to an existing line, to a side of an n-gon, to the periphery of a circle or ellipse, etc.

(1) Tap [Draw] and then [Point].

- This highlights the point button on the toolbar.

(2) Drag the stylus on the screen towards the line where you want to add the labeled point.

- This selects the line, which is indicated by "■".

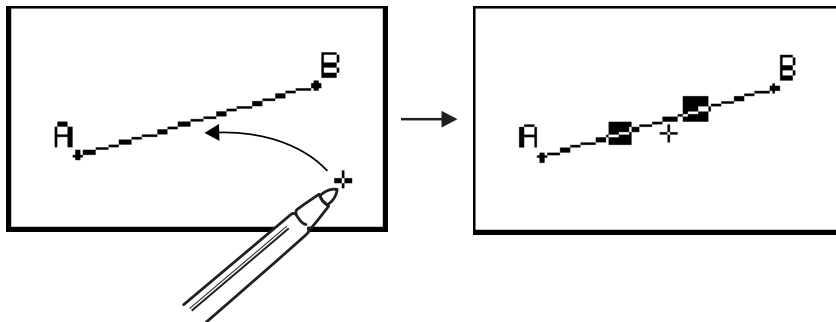

(3) Drag the stylus to the location on the line where you want to add a labeled point, and then lift the stylus from the screen.

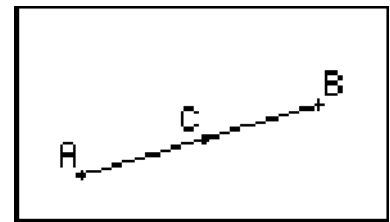

• **To draw an infinite line**

(1) Tap [Draw] and then [Infinite Line].

- This highlights the infinite line button on the toolbar.

(2) Tap two points on the screen through which you want the infinite line to pass.

- You could also tap one point and then drag to the second point.

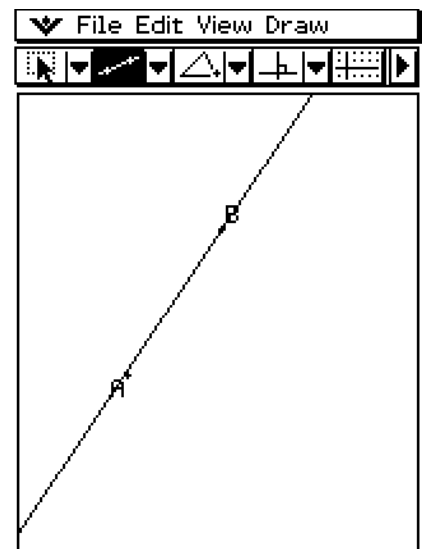



• To draw a ray

Example: To draw a ray and then determine its $y = f(x)$ linear equation by dropping the ray into the Main or eActivity application window

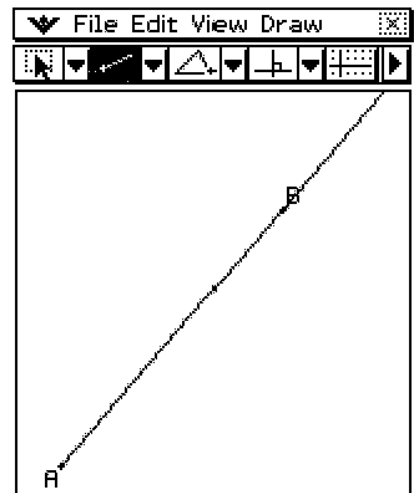
- (1) Tap [Draw] and then [Ray].
 - This highlights the ray button on the toolbar.
- (2) Tap two points on the screen.
 - You could also tap one point and then drag to the second point.



- (3) On the Icon panel, tap  to start up the Main application
- (4) Tap the right most down arrow button on the Main application toolbar. On the button list that appears, tap .
 - This opens the Geometry application and displays the line drawn in the step (2), above.
- (5) Use the stylus to select ray AB and drop it into the Main application window.
 - This displays a linear equation as shown here.

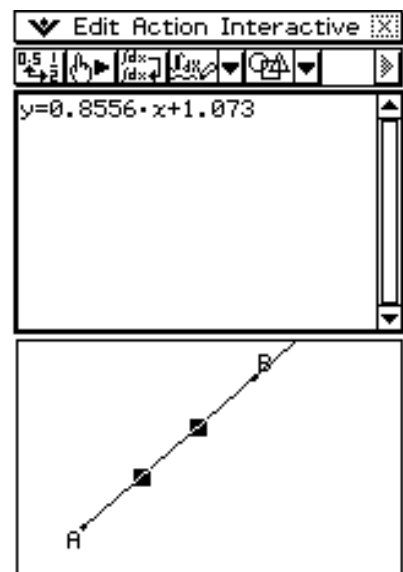

• **To draw a vector**

- (1) Tap [Draw] and then [Vector].
 - This highlights the vector button on the toolbar.
- (2) Tap the point where you want the vector to start, and then its end point.
 - You could also tap one point, and then drag to the vector end point.

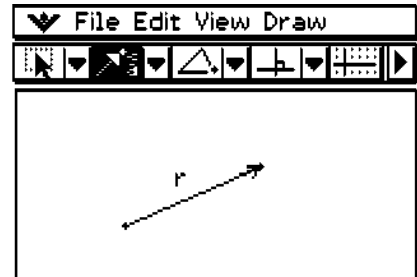

• **To draw a circle**

- (1) Tap [Draw] and then [Circle].
 - This highlights the circle button on the toolbar.
- (2) Tap the point where you want the center of the circle to be, and then tap a second point anywhere on the circle's circumference.
 - You could also tap the center point, and then drag to the second point.

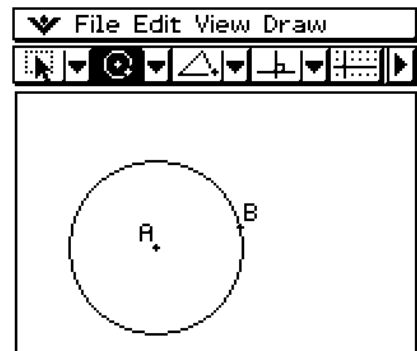

• **To draw an arc**

- (1) Tap [Draw] and then [Arc].
 - This highlights the arc button on the toolbar.
- (2) Tap the point where you want the center of the arc to be, and then tap a second point to designate where you want the arc to start.
- (3) Tap a third point, which is where you want the arc to end.

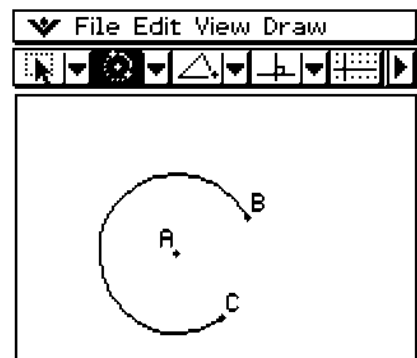

• To draw a function

Example: To draw $y(x) = x^2 - 1$

(1) Tap [Draw], [Function], and then [f(x)].

- This causes the Function dialog box and a soft keyboard to appear.

(2) Input the function.

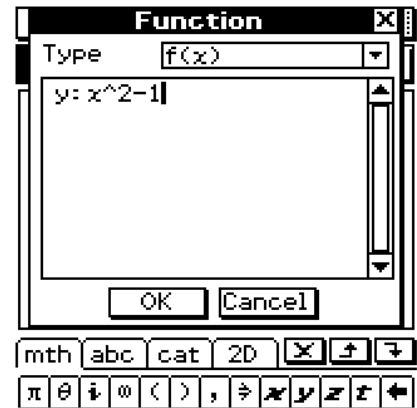

(3) Tap [OK] to draw it.

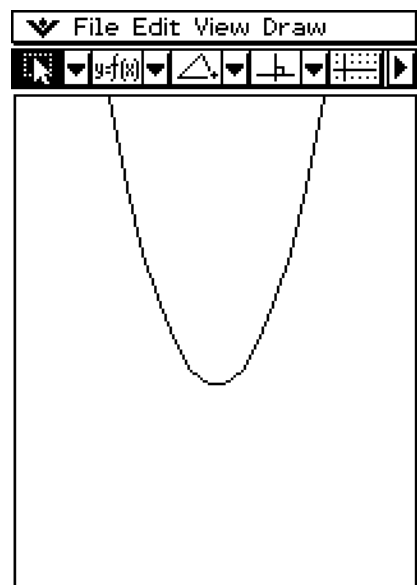

• To draw a polar equation graph

Note

In this example the [Function Angle] setting of the Geometry Format dialog box is set to “Radian”. See page 1-9-10 for more information.

(1) Tap [Draw], [Function], and then [Polar].

- This displays the Function dialog box and a soft keyboard as shown here.



(2) Input the equation “ $r=\theta$ ” here and then tap [OK].

- This displays a polar equation graph as shown here.

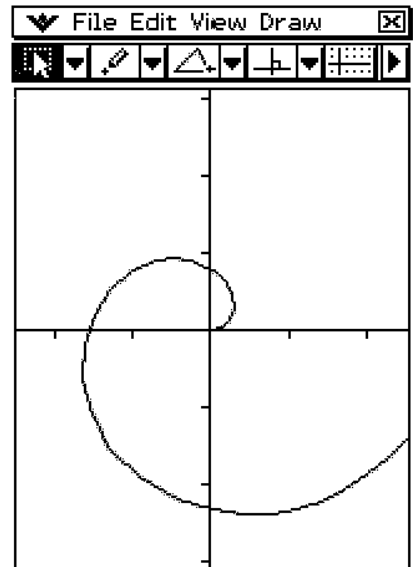

Tip

- You can drag a polar curve from the Geometry window and drop it into a Main or eActivity window. Or, for example, you can drag the equation $r = f(\theta)$ from the Main or eActivity window and drop it into the Geometry window as shown below.

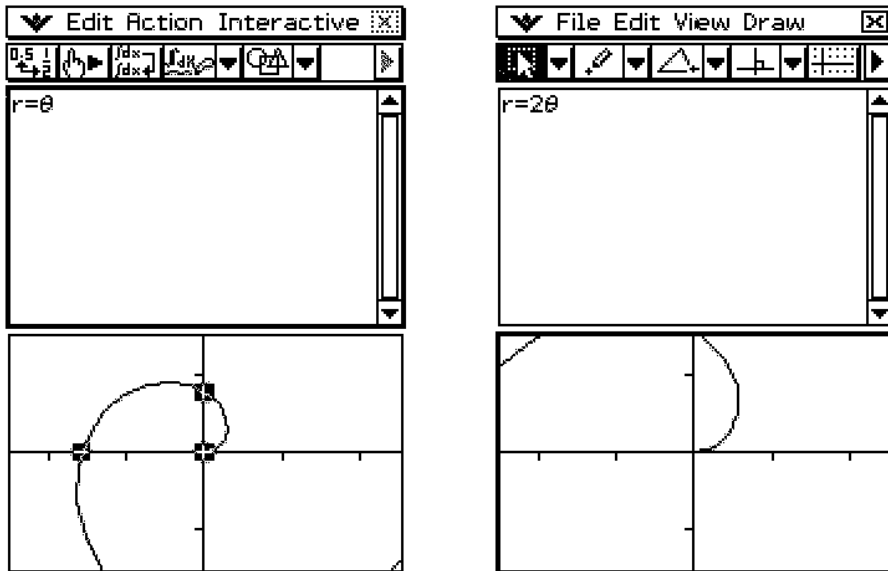

• **To draw a parametric equation graph**

Note

In this example the [Function Angle] setting of the Geometry Format dialog box is set to “Degree”. See page 1-9-10 for more information.

(1) Tap [Draw], [Function], and then [Parametric].

- This displays the Function dialog box and a soft keyboard.

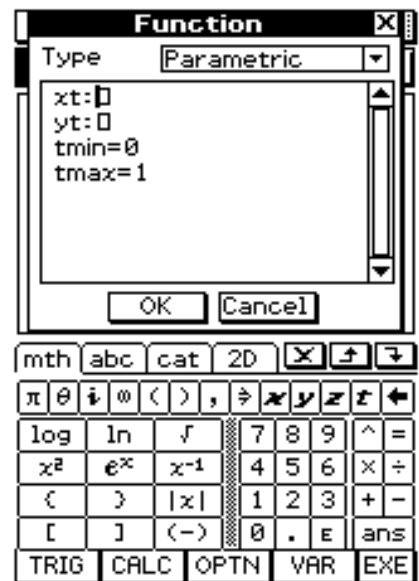

(2) Input the following expressions and values:

$$x(t) = \cos(t), y(t) = \sin(t), t_{\min} = 0, t_{\max} = 360$$

(3) Tap [OK].

- This displays a parametric equation graph as shown here.

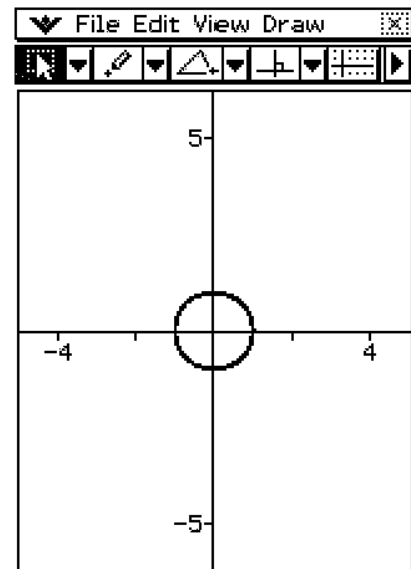

Tip

- You can display equations such as $(x(t), y(t))$ on the Geometry window by dragging the equation and dropping it into the Main or eActivity window. When you do, however, the equation appears as text (it does not graph the equation).

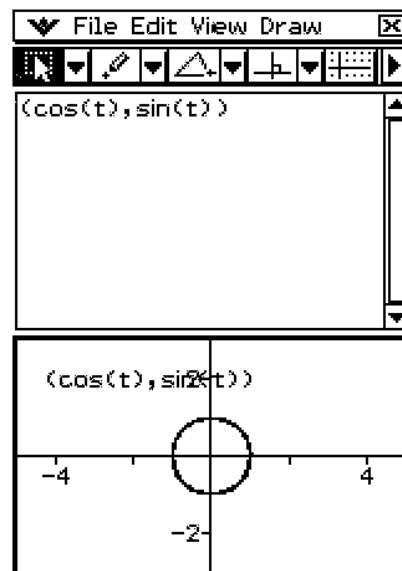
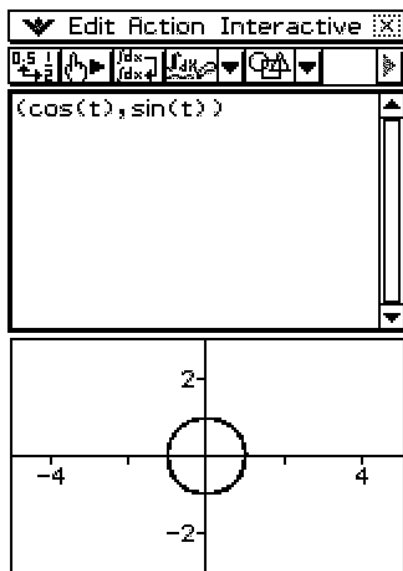

• To draw an ellipse using the [Ellipse] - [Axes] command

Note

When you draw an ellipse using the [Ellipse] - [Axes] command, you need to specify the following three elements: center point, Point 1 and Point 2. Point 1 defines the minor axis (nearest point on the edge from the center point) and Point 2 defines the major axis (farthest point on the edge from the center point).

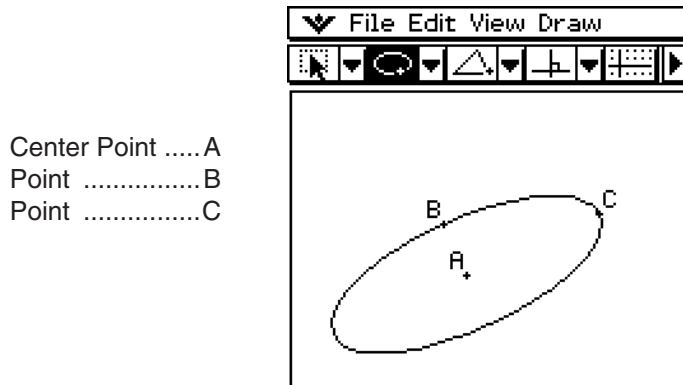

When AC is shorter than AB, Point 1 becomes the major axis and Point 2 becomes the minor axis.

- (1) Tap [Draw], [Ellipse], and then [Axes].
 - This highlights the ellipse axes button on the toolbar.
- (2) Tap the point you want to specify as the center point.
- (3) Tap the point you want to specify as Point 1 (minor axis).
 - This causes a line to appear between the center point and Point 1.
 - Instead of tapping, you could drag the stylus from the center point to Point 1, viewing the line that is drawn as you do.
- (4) Tap or drag to the point you want to specify as Point 2 (major axis).
 - This causes the ellipse to appear.

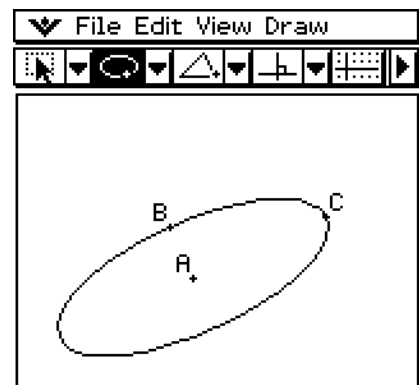

• To draw an ellipse using the [Ellipse] - [Foci] command

Note

An *ellipse* is the locus of points, the sum of whose distances from two fixed points (called *foci*) is a constant. An ellipse drawn using the [Ellipse] - [Foci] command is drawn in accordance with this definition. When you draw an ellipse with the [Foci] command, you need to specify three different points: two foci (Point 1 and Point 2) and one point anywhere on the ellipse (Point 3).

Point 1 A
Point 2 B
Point 3 C

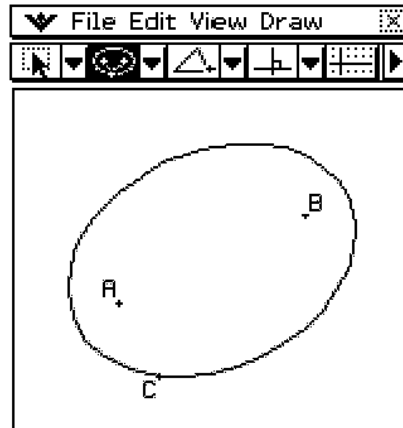

(1) Tap [Draw], [Ellipse], and then [Foci].

- This highlights the ellipse foci button on the toolbar.

(2) On the screen, tap the two points that you want to specify as the foci of the ellipse (Point 1 and Point 2).

- This causes a line to appear between Point 1 and Point 2.

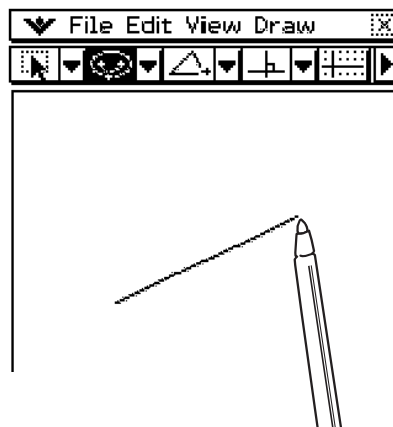

- Instead of tapping two points as described above, you could also specify the two foci by tapping to define Point 1 and then dragging the stylus across the screen to Point 2.

(3) Tap the point you want to specify as Point 3.

- This specifies the point you tap as Point 3 and draws the ellipse.

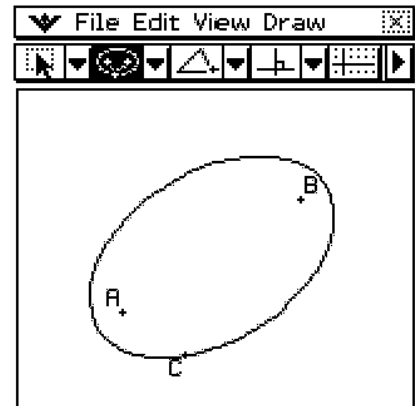

- Instead of tapping the screen to specify Point 3, you could also drag the stylus on the display. As soon as you tap and hold the stylus on the screen, the line connecting Point 1 and Point 2 will bend to show the distance from the foci to the location of the stylus, as shown below. Move the stylus to the location where you want Point 3 to be and then remove it. This will cause the ellipse to be drawn.

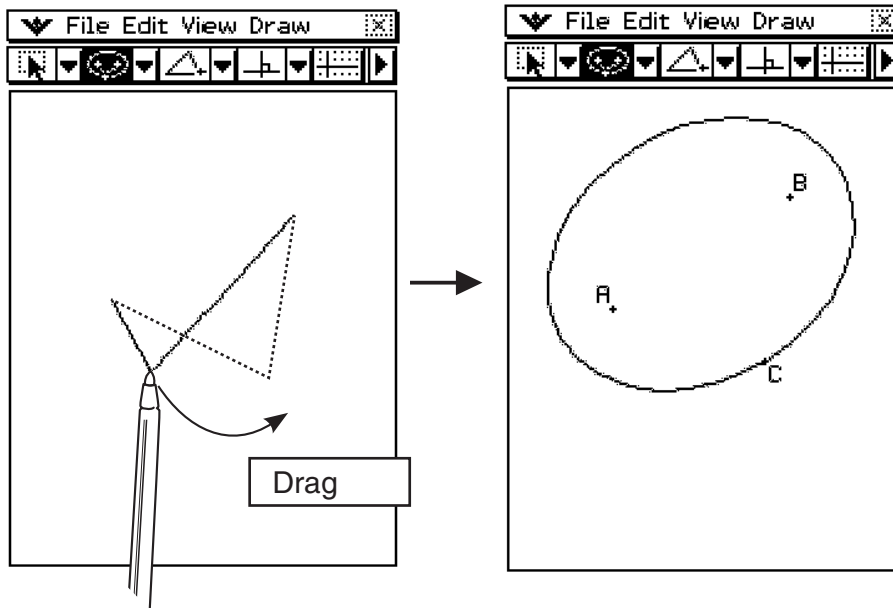

• To draw a hyperbola

Note

A *hyperbola* is the locus of points, the difference of whose distances from two fixed points (called *foci*) is a given value. A hyperbola drawn using the [Hyperbola] command is drawn in accordance with this definition. When you draw a hyperbola with the [Hyperbola] command, you need to specify three different points: two foci (Point 1 and Point 2) and one point anywhere on the hyperbola (Point 3).

Point 1 A
Point 2 B
Point 3 C

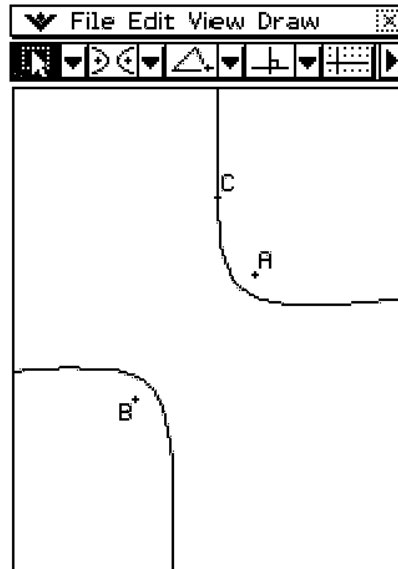

(1) Tap [Draw] and then [Hyperbola].

- This highlights the hyperbola button on the toolbar.

(2) On the screen, tap the two points that you want to specify as the foci of the hyperbola (Point 1 and Point 2).

- This causes a line to appear between Point 1 and Point 2.
- Instead of tapping two points as described above, you could also specify the two foci by tapping to define Point 1 and then dragging the stylus across the screen to Point 2.

(3) Tap the point you want to specify as Point 3.

- This specifies the point you tap as Point 3 and draws the hyperbola.

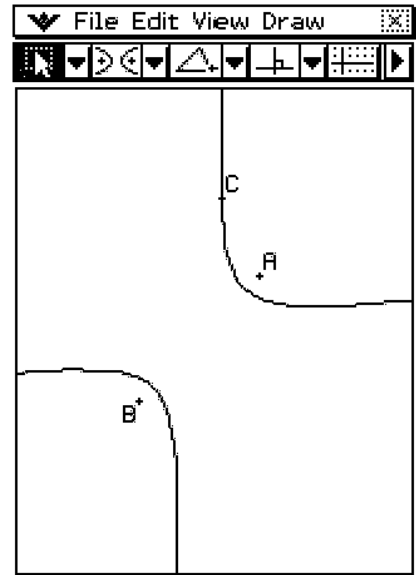

- Instead of tapping the screen to specify Point 3, you could also drag the stylus on the display. As soon as you tap and hold the stylus on the screen, the line connecting Point 1 and Point 2 will bend to show the distance from the foci to the location of the stylus, as shown below. Move the stylus to the location where you want Point 3 to be and then remove it. This will cause the hyperbola to be drawn.

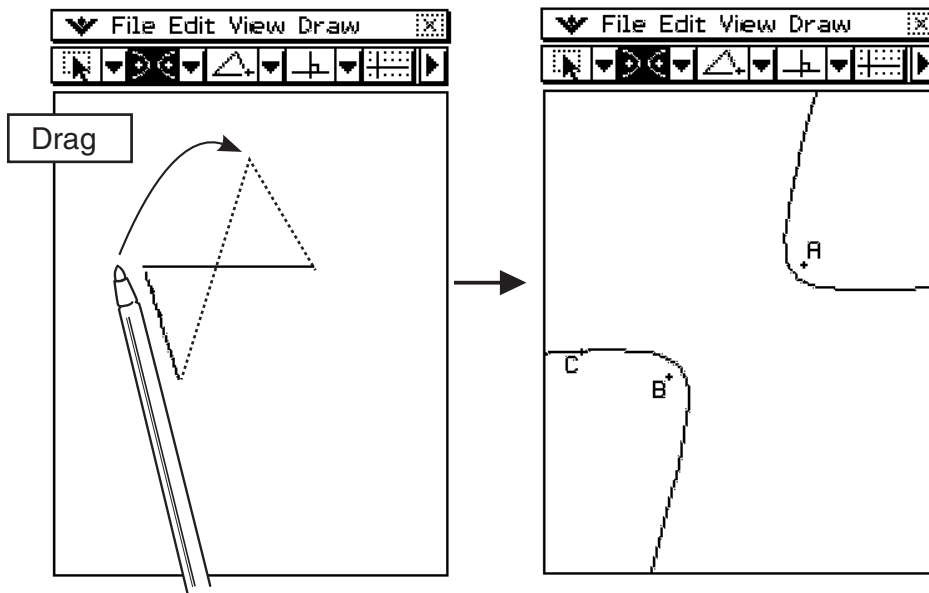

• To draw a parabola

Note

A *parabola* is the locus of points equidistant from a point (the focus) and a line (the directrix). A parabola drawn using the [Parabola] command is drawn in accordance with this definition. When you draw an parabola with the [Parabola] command, you need to specify three different points: a line to define the directrix (Point 1 and Point 2) and one point for the focus.

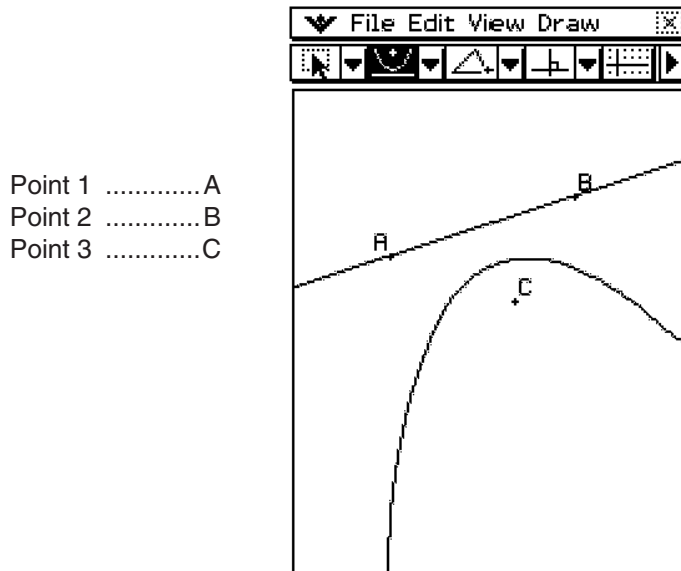

- (1) Tap [Draw] and then [Parabola].
 - This highlights the parabola button on the toolbar.
- (2) On the screen, tap the two points that you want to specify the directrix (Point 1 and Point 2).
 - This causes a line to appear between Point 1 and Point 2.
- (3) Tap the point you want to specify as Point 3.
 - This specifies the point you tap as Point 3 and draws a parabola in relation to it and the directrix.

• **To draw a polygon**

- (1) Tap [Draw] and then [Polygon].
 - This highlights the polygon button on the toolbar.
- (2) Tap the point from which you want the polygon to start.
- (3) Sequentially tap each of the vertices of the polygon.
- (4) Finally, tap the start point again to complete the polygon.

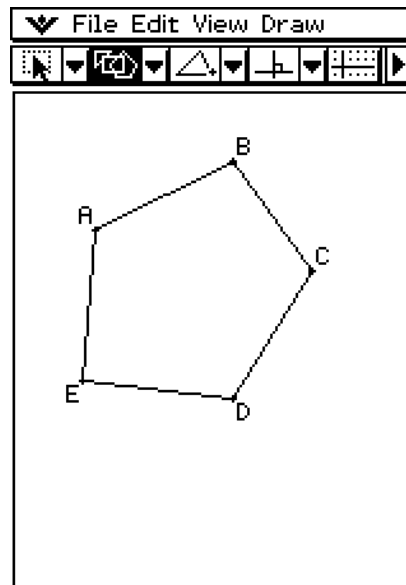
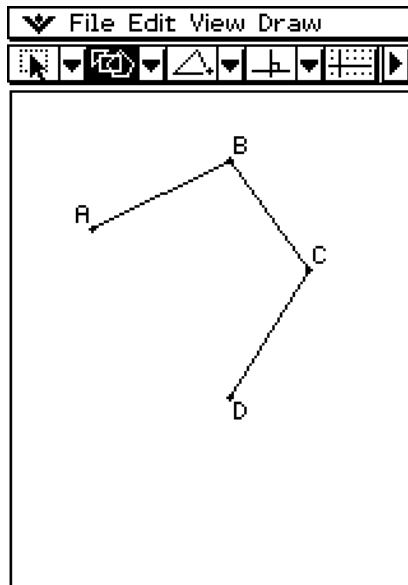

Inserting Text Strings into the Screen

You can insert text strings into the screen while working on the Geometry application window.

• To insert a text string into a screen

(1) Tap [Draw] and [Text].

- This displays the Text dialog box and a soft keyboard.

(2) Input the text you want on the dialog box.

- You can input alphanumeric characters, and you can use the 2D keyboard to input numeric expressions (see “Using the 2D Keyboard” on page 1-6-15).



(Alphanumeric Input)



(Numeric Expression Input
Using the 2D Keyboard)

(3) Tap [OK] to insert the text into the screen.

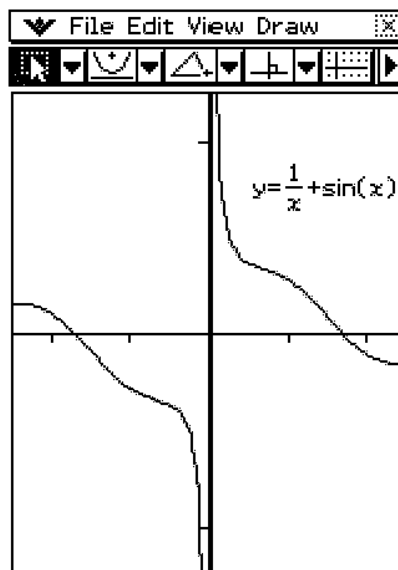
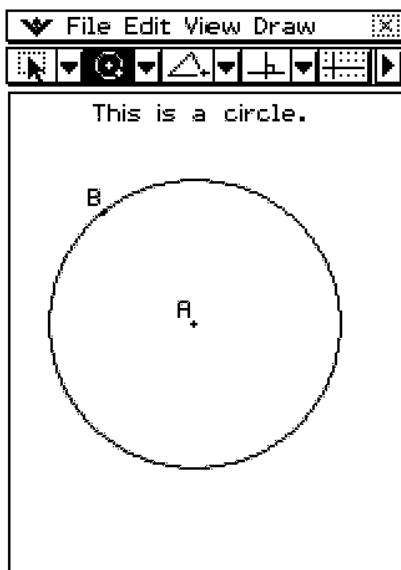

Drag and Drop

Text on the Geometry window can be dragged to the Main or eActivity window. You can also drop text from these application windows into the Geometry window.

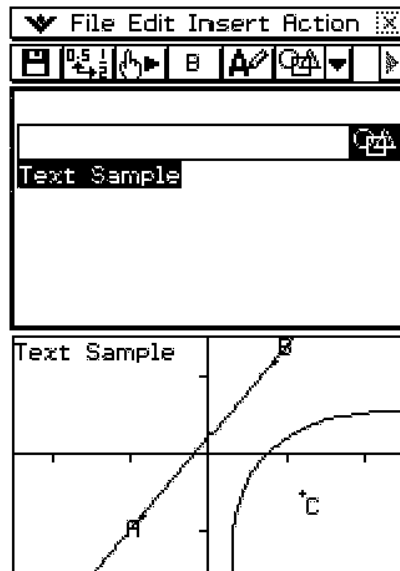

Attaching an Angle Measurement to a Figure

The measurement of an angle formed by two sides of a figure can be attached to the figure as shown here. To do so, tap [Attached Angle] on the [Draw] menu.

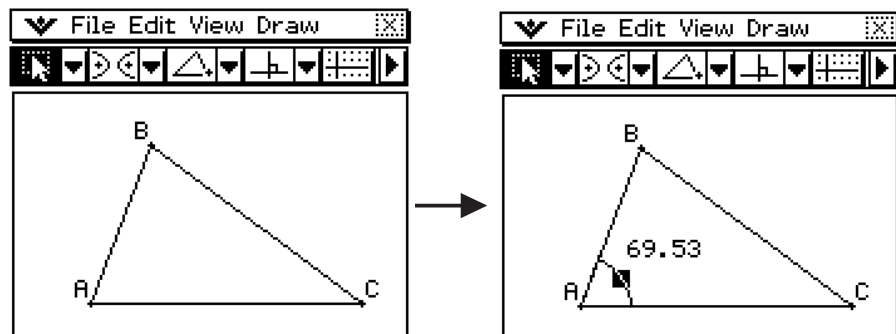

• **To attach an angle measurement to a figure**

Example: To attach the measurement of angle A in the triangle ABC

- (1) Draw the triangle.
- (2) Tap . Next, tap side AB and then side AC to select them.
- (3) Tap [Draw] and then [Attached Angle].
 - This attaches the angle measurement to the figure.

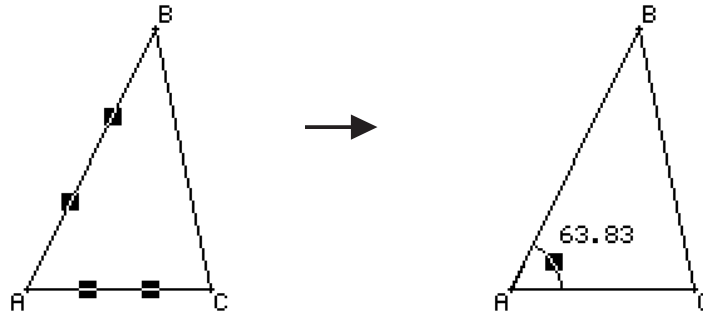

Tip

- The two sides of a figure actually forms four angles, numbered ① through ④ in the illustration shown here. After attaching an angle measurement using the [Attached Angle] command, you can drag it to the position of any one of the other three angles as shown in the examples below.

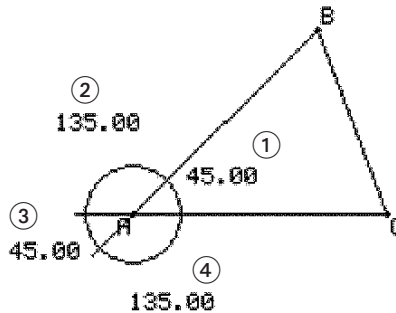

Example: To drag the angle measurement attached to interior angle A of triangle ABC to its exterior complementary angle

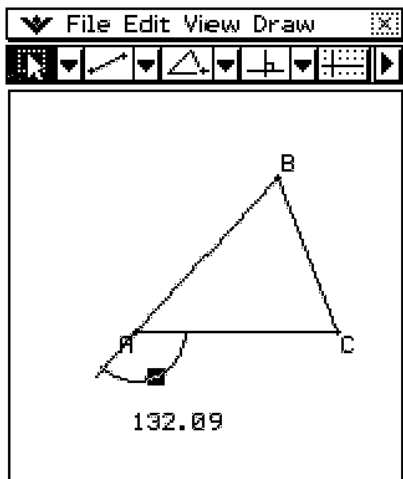
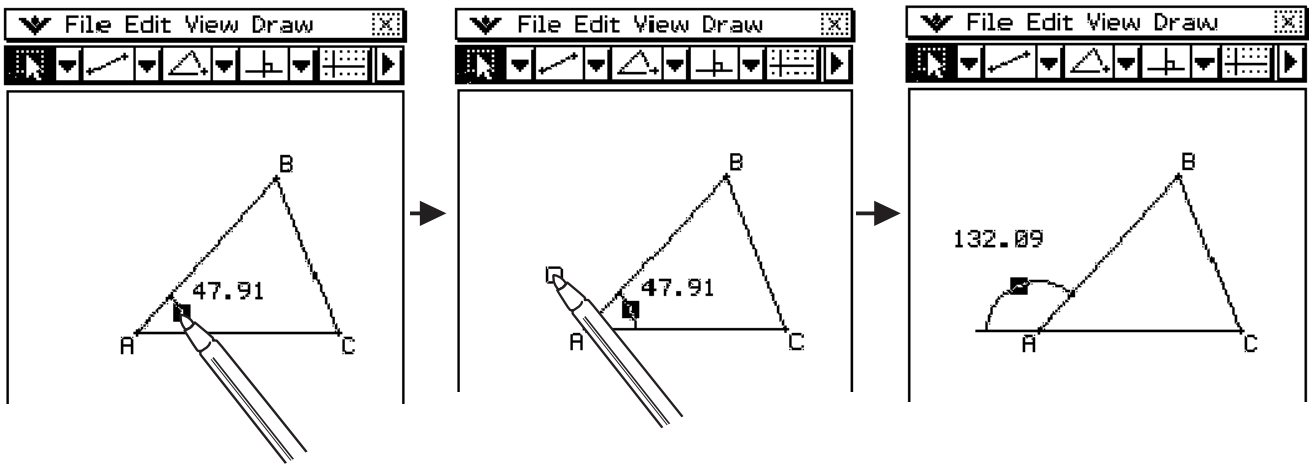

(Dragging to the complementary angle of the opposite angle of A)

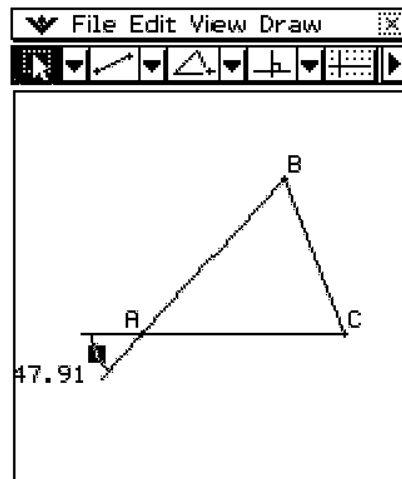

(Dragging to the opposite angle of A)

Tip

- You can display more than one attached angle. To do this in the above example, first drag the initial attached angle to the exterior position and then repeat steps 1 through 3 under “To attach an angle measurement to a figure” on page 8-2-20.



Displaying the Measurements of a Figure

You can display measurements on the Geometry application window. The measurements change dynamically as you manipulate the figure.



A List of [Measurement] Submenu Commands on the [Draw] Menu

Names of Commands	Meanings of Each Command
Angle	Angle between two lines
Supplementary Angle	Supplementary angle of extended lines
Area	Area of selected figure
Circumference	Circumference of selected figure
Coordinates	Coordinates of selected point
Direction	Direction of line or vector
Equation	Equation of selected curve
Length	Distance between two points, or length of line
Radius	Radius of circle
Slope	Slope of line or vector

Note

There are three ways to display measurements while you work on the Geometry application window. The following examples show you each method.

Method 1: Selecting [Measurement] from the [Draw] menu

- (1) Tap  and select elements AB and AC.
- (2) Tap the  button to the right of the toolbar.
 - This displays the measurement box, which indicates the specified angle.

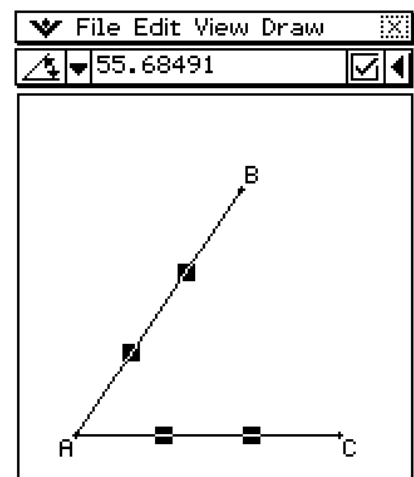

(3) Tap [Draw], [Measurement], and then [Angle].

- This shows the angle measurement on the screen.

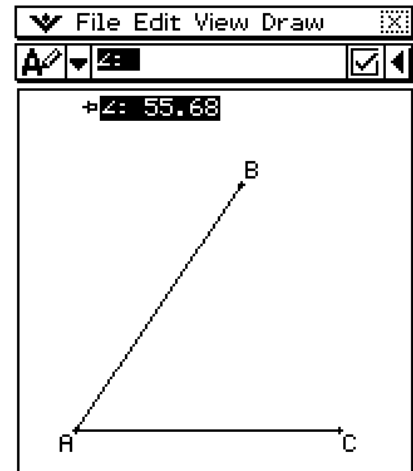

Method 2: Selecting the value in the measurement box and dropping it directly into the Geometry application window

(1) Tap  and select elements AB and AC.

(2) Tap the  button to the right of the toolbar.

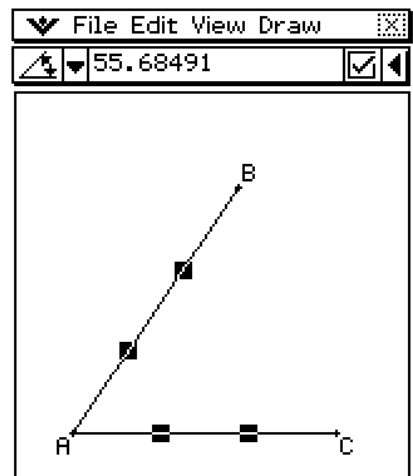

- This displays the measurement box, which indicates the specified angle.



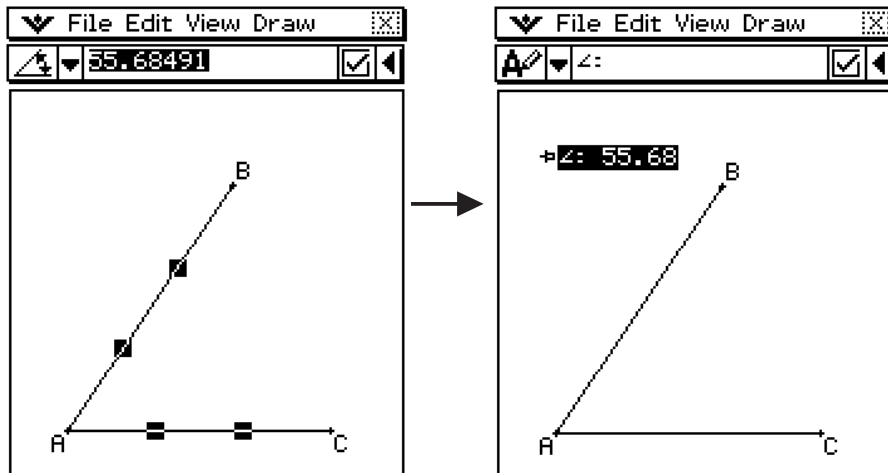

- (3) Select (highlight) value in the measurement box and drop it into the screen below.
- This displays the specified angle measurement on the screen as shown below.

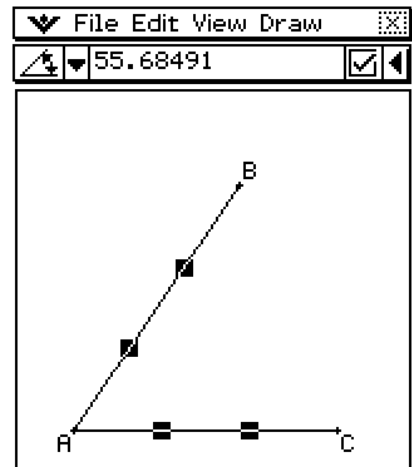

Method 3: Tapping the measurement icon button to the left of the measurement box

- (1) Tap  and select elements AB and AC.
- (2) Tap the  button to the right of the toolbar.
 - This displays the measurement box, which indicates the specified angle.



- (3) Tap the  button on the far left of the measurement box.
 - This displays the specified angle measurement on the screen as shown here.

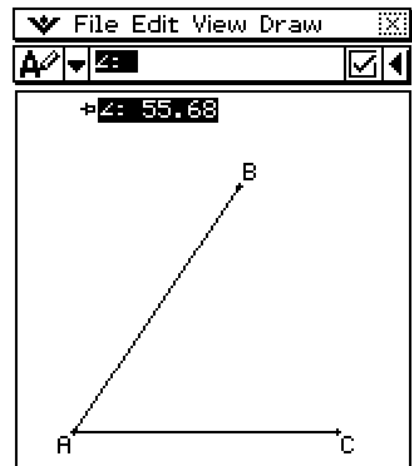

Displaying the Result of a Calculation that Uses On-screen Measurement Values

You can use the [Expression] command and the commands on the [Measurement] submenu to perform calculations using the angle value, line length, surface area, and other measurement values attached to a figure, and display the result on the Geometry window.

• To display the result of a calculation that uses on-screen measurement values

Example: With line segment AB and line segment CD (point C being on AB) drawn on the display as shown here, calculate the sum of attached angles DCB and ACD, and display the result on the screen. ($57.72 + 122.28 = 180.00$)

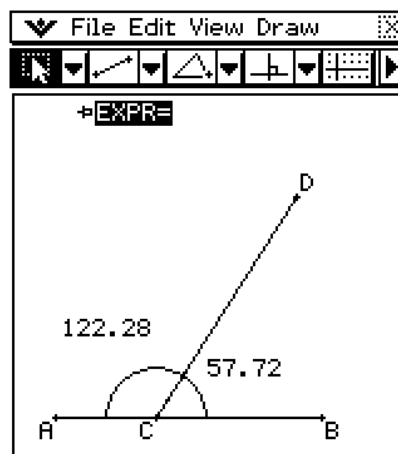

• ClassPad Operation

Steps (1) through (5) draw the figure shown above. The procedure from step (6) performs the calculation using the on-screen measurement values.

- (1) Tap [Draw] - [Line Segment] and then draw line segment AB.
 - See "To draw a line segment using the menu command" on page 8-2-2.
- (2) Draw line segment CD so that point C lies on line segment AB.
- (3) Tap .
- (4) Select line segment AB and line segment CD, and then tap [Draw] - [Attached Angle].
 - This displays the attached angle for ACD.
- (5) Tap attached angle ACD and drag it inside of angle DCB.
 - This moves the attached angle to angle DCB.
- (6) Select line segments AB and CD again, and then tap [Draw] - [Attached Angle].
 - This displays the attached angle for ACD.
- (7) Tap [Draw] - [Expression].
 - This displays an "EXPR=" object.

- (8) Tap the  button to the right of the toolbar. This will display the measurement box.
- The above will also display numeric labels for each measurement currently on the screen.

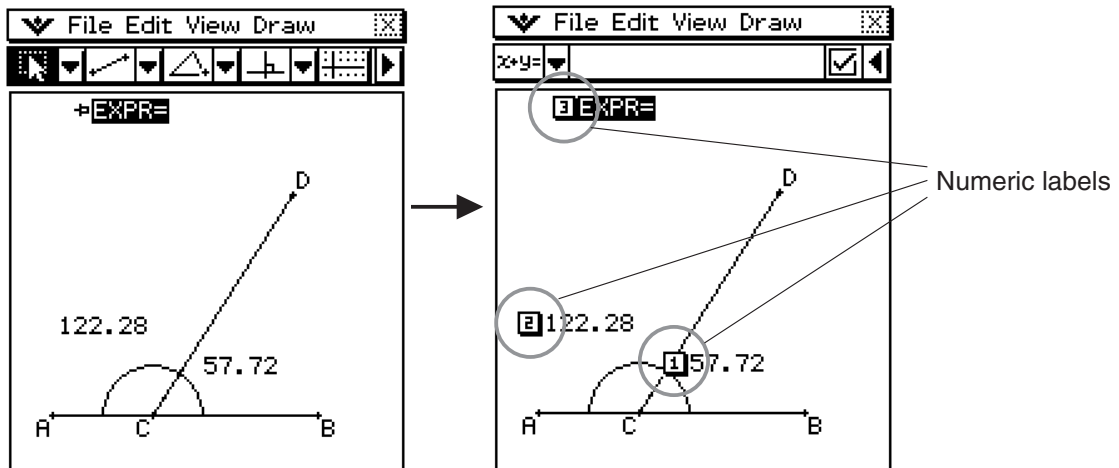

- (9) Now you can use the numeric labels to specify measurement values in the calculation you input in the measurement box.
- To input a measurement value in the measurement box, input the at sign (@) followed by the numeric label of the value. To input value [1], for example, you would input “@1”.
 - Since we want to calculate the sum of angles DCB ([1]) and ACD ([2]) here, you would input the following: @1+@2.

- (10) After inputting the calculation expression, press .

- The calculation result is displayed to the right of “EXPR=”.

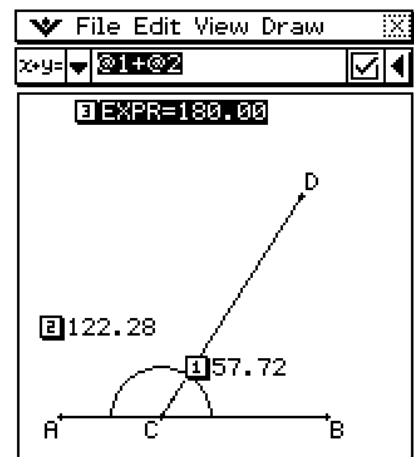

Tip

In steps (8) and (9) above, you also can input the numeric label of a displayed measurement value into the measurement box by tapping the label. Tapping [1], for example, will input “@1” into the measurement box.

Using the Special Shape Submenu

The [Special Shape] submenu allows you to draw specially shaped figures automatically. Simply select the type of figure you want from the menu, and then touch the screen with the stylus to draw it. Or, touch the screen with your stylus and drag to create a box indicating the size of the figure you would like to draw.

Each of the [Special Shape] submenu figures is also available on the toolbar.

[Draw] – [Special Shape]

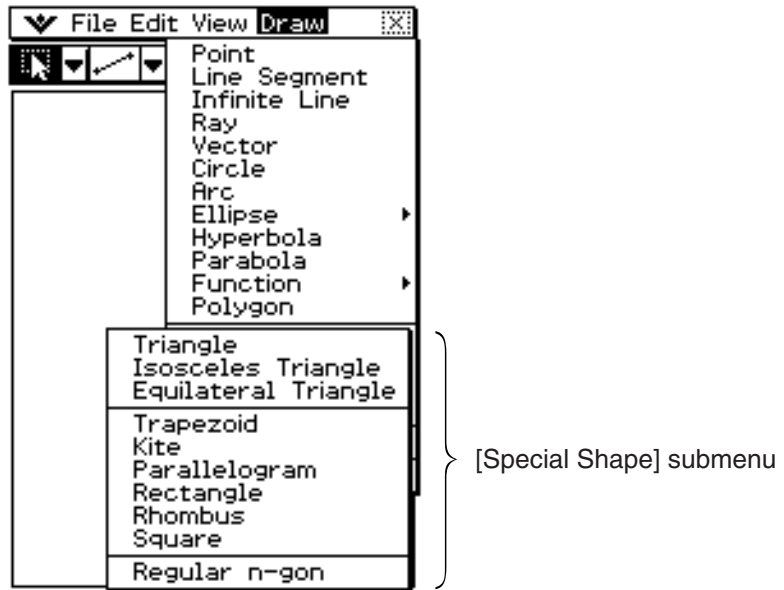

Toolbar

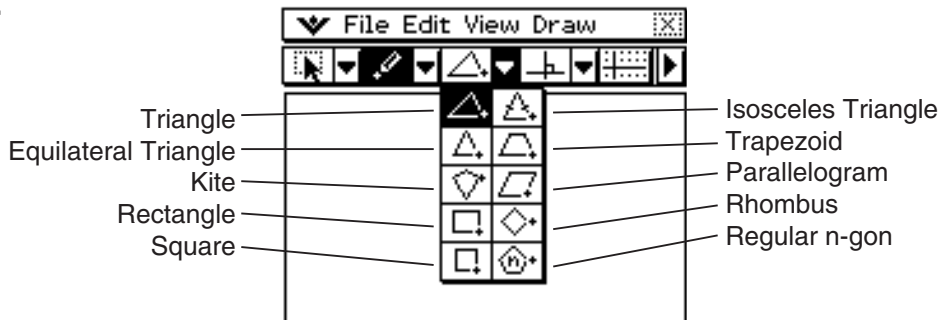

• **To draw a triangle**

- (1) Tap [Draw], [Special Shape], and then [Triangle].
 - This highlights the triangle button on the toolbar.
- (2) Perform either of the following two operations to draw the triangle.
 - Tap the screen with the stylus. This automatically draws the acute triangle you selected.
 - Place the stylus on the screen and drag diagonally in any direction. This causes a selection boundary to appear, indicating the size of the triangle that will be drawn. The triangle is drawn when you release the stylus.

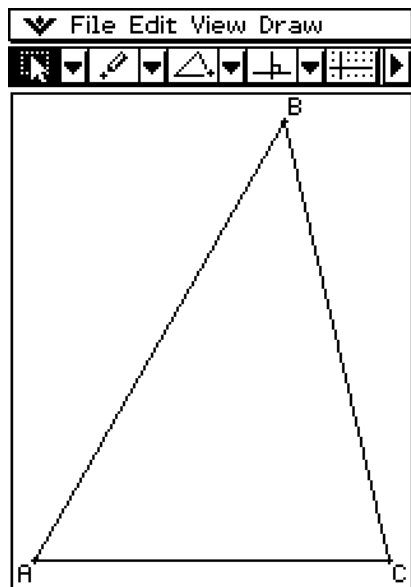

Tapping the screen with the stylus

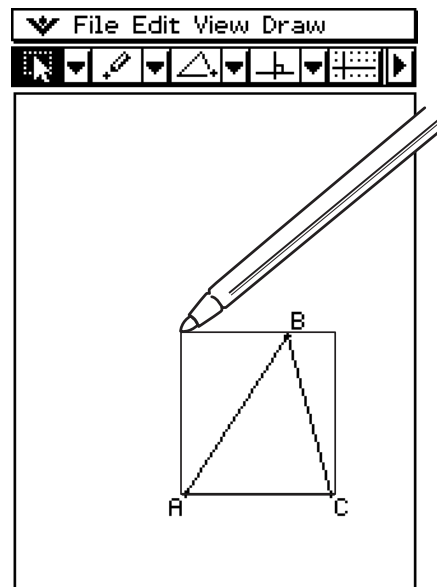

Dragging with the stylus

• **To draw a regular polygon**

- (1) Tap [Draw], [Special Shape], and then [Regular n-gon].
 - This highlights the regular n-gon button on the toolbar, and displays the n-gon dialog box.
- (2) Enter a value indicating the number of sides of the polygon, and then tap [OK].

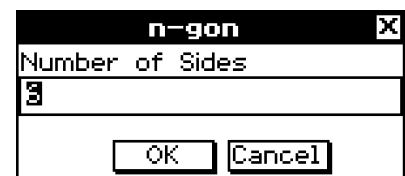

(3) Perform either of the following two operations to draw the regular polygon.

- Tap the screen with the stylus. This automatically draws the polygon you selected.
- Place the stylus on the screen and drag diagonally in any direction. This causes a selection boundary to appear, indicating the size of the polygon that will be drawn. The polygon is drawn when you release the stylus.

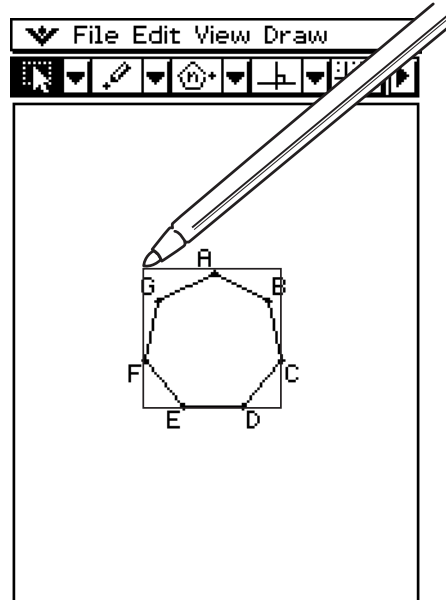
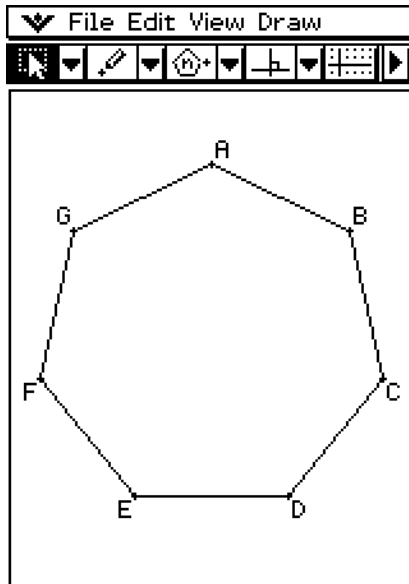

Using the Construct Submenu

The [Construct] submenu provides you with the means to study various geometric theorems. In addition to tools for constructing a perpendicular bisector, perpendicular line, angle bisector, midpoint, intersection, parallel lines and a tangent to a curve, you can also translate, rotate, reflect, dilate, or transform a figure.

Each of the [Construct] submenu figures is also available on the toolbar.

[Draw] – [Construct]

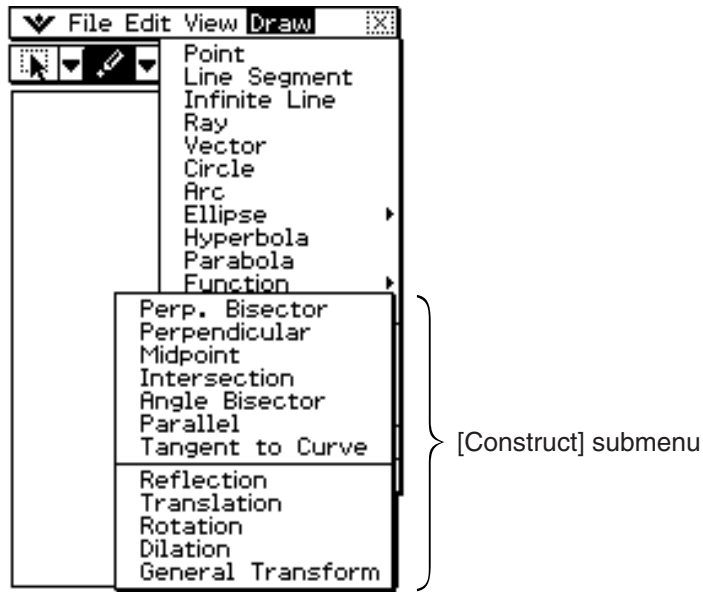

Toolbar

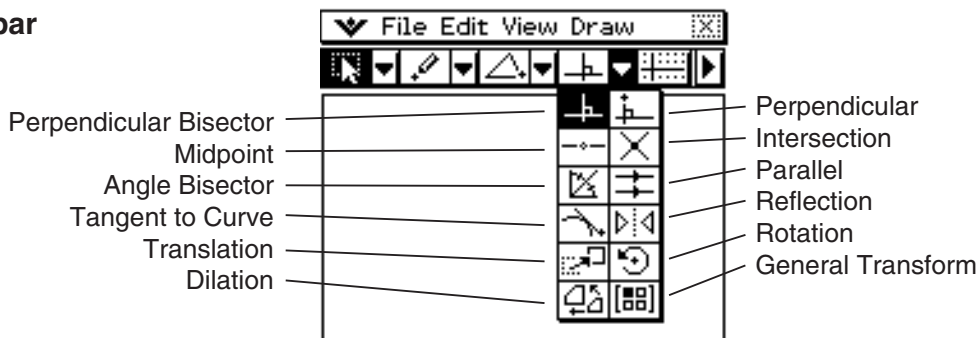

Tip

- The following procedures include steps that require selection of a line segment or other figures. For details about selecting figures, see “8-3 Editing Figures”.

• **To construct a perpendicular bisector**

- (1) Draw a line segment.
- (2) Tap , and then select the line segment.
- (3) Tap [Draw], [Construct], and then [Perp. Bisector].
 - This draws a perpendicular bisector through your line segment.

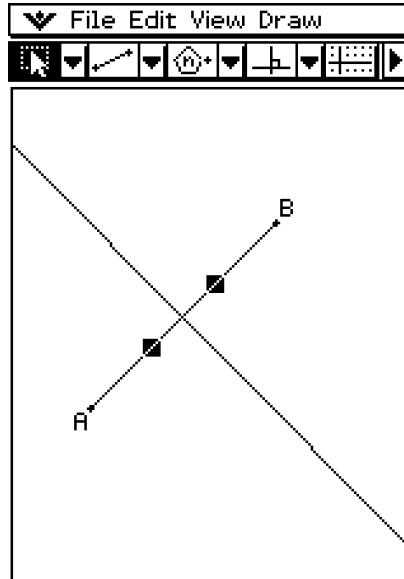
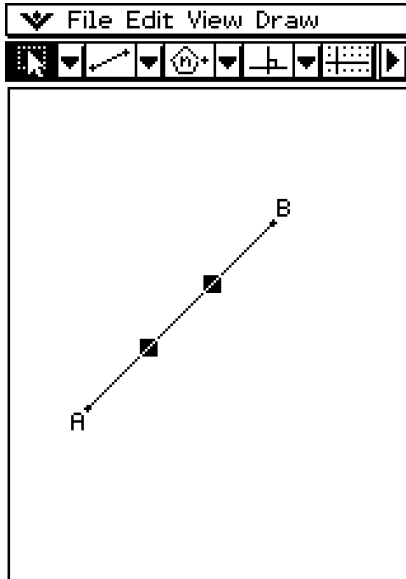

• **To construct an angle bisector**

- (1) Draw two line segments so they form an angle.
- (2) Tap , and then select both line segments.
- (3) Tap [Draw], [Construct], and then [Angle Bisector].
 - This bisects the angle.

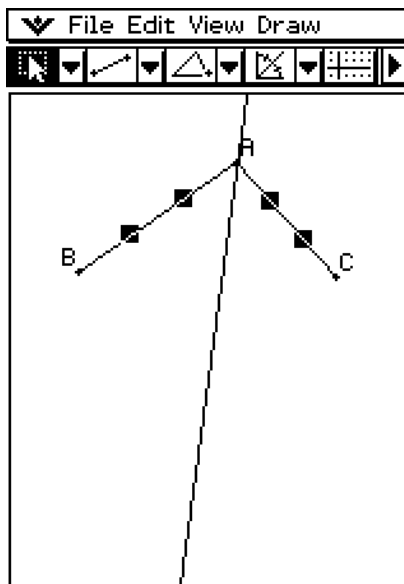
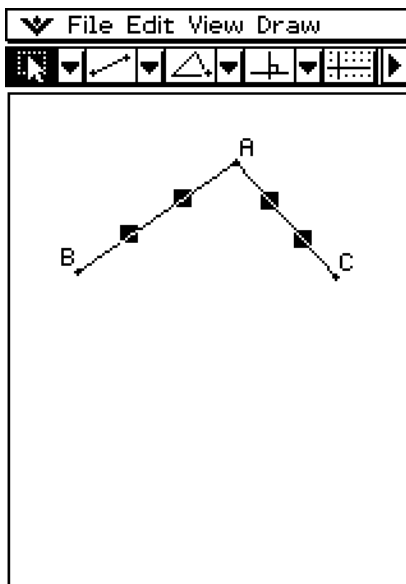

• **To construct a midpoint**

- (1) Draw a line segment.
- (2) Tap , and then select the line segment.
- (3) Tap [Draw], [Construct], and then [Midpoint].
 - This adds a midpoint to the segment.

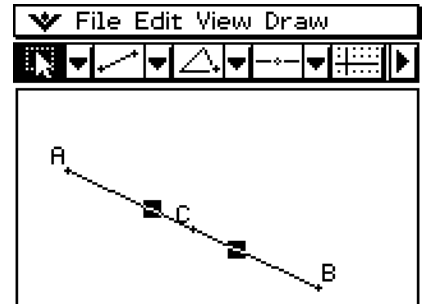

• **To construct the point of intersection of two lines**

- (1) Draw two lines that intersect.
- (2) Tap , and then select both lines.
- (3) Tap [Draw], [Construct], and then [Intersection].
 - This adds the point of intersection.

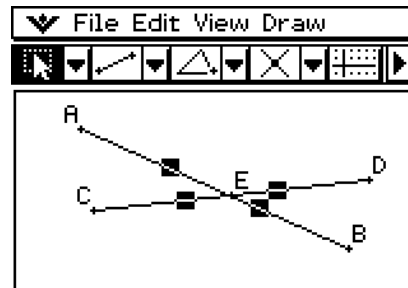
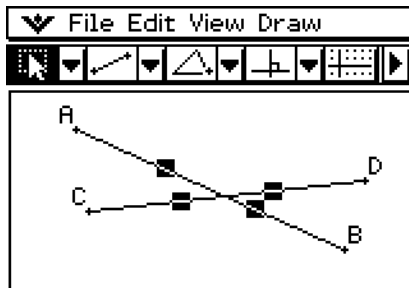

- (4) Try selecting the point of intersection and dragging it.

Tip

- The point(s) of intersection of two circles or of a line and a circle can be constructed in the same manner.

• **To construct a perpendicular line that passes through a specified point on a line**

- (1) Draw a line segment or an infinite line.
- (2) Draw a point on the line through which you want the perpendicular line to pass.
- (3) Tap , and then select the point and the line.
- (4) Tap [Draw], [Construct], and then [Perpendicular].
 - This draws a line that through the point you selected, which is perpendicular to the line where is the point is located.
 - Try selecting the point of intersection and dragging it.

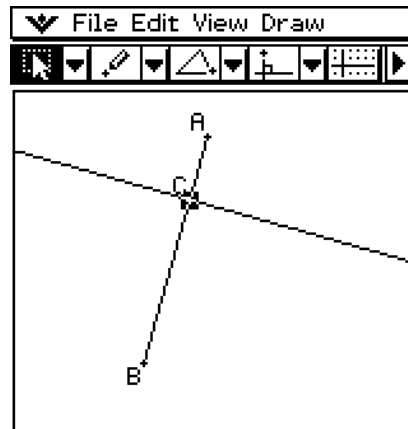
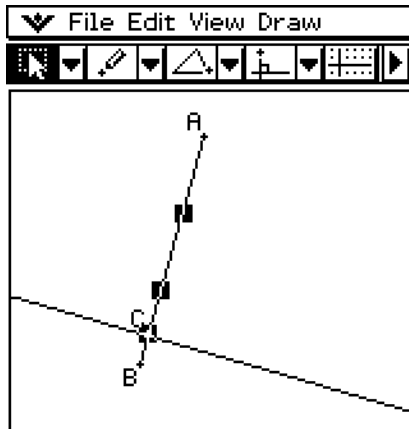

• **To construct a line parallel to another line through a specified point**

- (1) Draw a line and a point that is not on the line.
- (2) Tap , and then select the line and the point.
- (3) Tap [Draw], [Construct], and then [Parallel].
 - The parallel line button is displayed on the toolbar, and a line passing through the selected point is drawn parallel to the selected line.

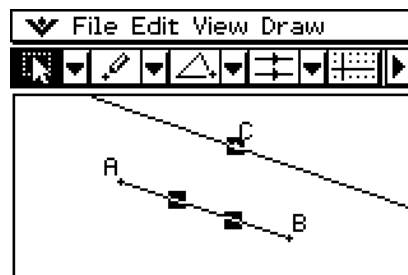
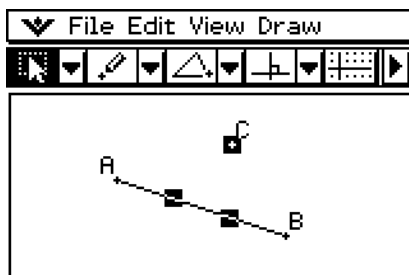

• **To construct a tangent to a curve through a specified point**

- (1) Draw a curve, such as an ellipse.
- (2) Tap [Draw], [Construct], and then [Tangent to Curve].
 - This highlights the tangent to a curve button on the toolbar.
- (3) Tap the point of tangency on the curve.
 - This draws the tangent.

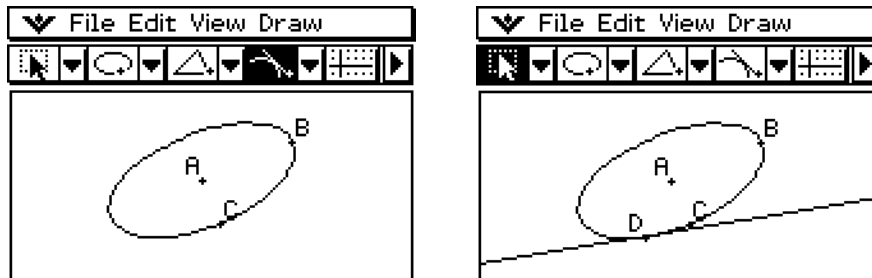

• **To translate a line segment by inputting a vector**

- (1) Draw a line segment (AB), and then select it.

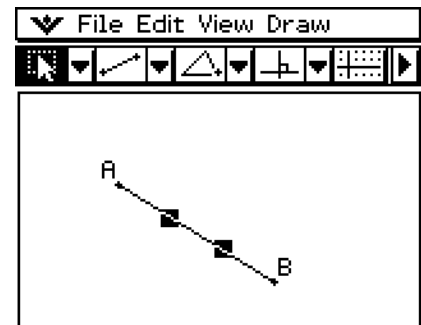

- (2) Tap [Draw], [Construct], and then [Translation].
 - This displays the Translation dialog box.
- (3) Enter the vector for the translation.

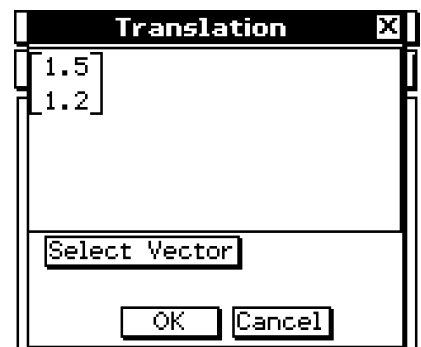

(4) Tap [OK].

- This translates line segment AB in accordance with the vector value you input, and draws line segment A'B'.

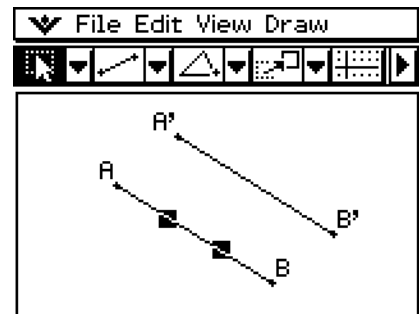

• **To translate a line segment by selecting a vector**

- (1) Draw a line segment (AB), and a vector to use in the translation. Next, select the line segment.
 - This displays the Translation dialog box.
- (2) Tap [Draw], [Construct], and then [Translation].
 - This displays the Translation dialog box.
- (3) Tap [Select Vector].
- (4) Tap the vector on the screen.
 - This translates line segment AB in accordance with the vector you selected, and draws line segment A'B'.

• **To rotate a line segment**

- (1) Draw a line segment, and then select it.
- (2) Tap [Draw], [Construct], and then [Rotation].
 - This highlights the rotate button on the toolbar.
- (3) Tap the screen once to select the center of rotation.
 - This displays the Rotation dialog box.
- (4) Specify the angle of rotation in degrees.

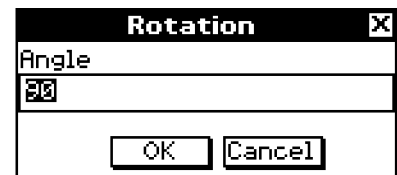

(5) Tap [OK] to rotate the line segment.

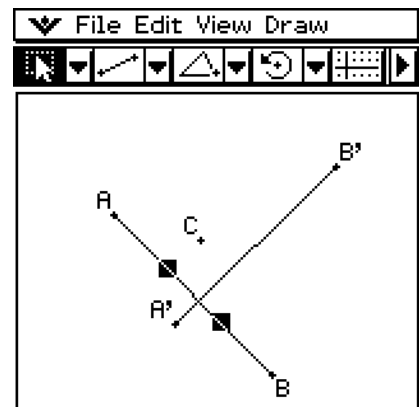

• **To reflect a line segment with respect to a specified line of symmetry**

- (1) Draw a line segment.
- (2) Draw a line to use as the line of symmetry.
- (3) Tap , and then select the line segment.
- (4) Tap [Draw], [Construct], and then [Reflection].
 - This highlights the reflection button on the toolbar.
- (5) Tap the line of symmetry.
 - This reflects the line segment you drew in step (1) about the line of symmetry.

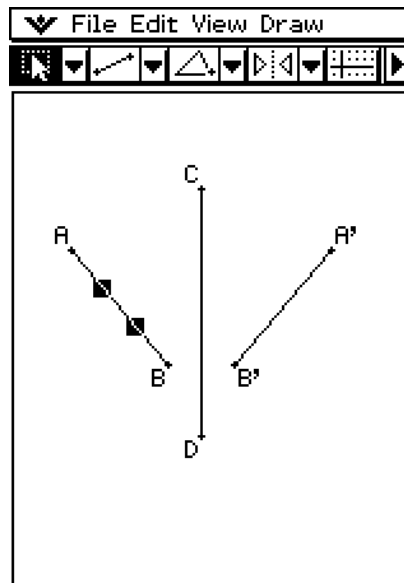
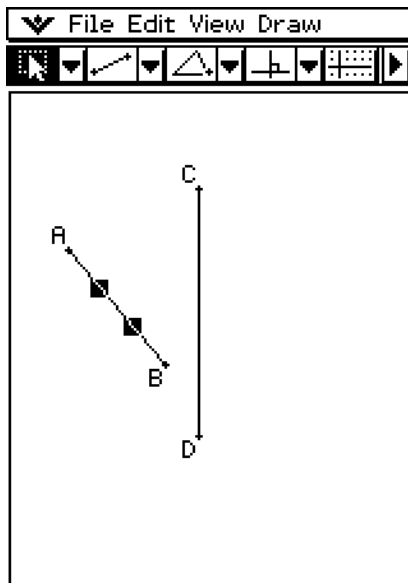

• **To dilate a line segment toward a specified center point**

- (1) Draw a line segment, and then select it.
 - (2) Tap [Draw], [Construct], and then [Dilation].
 - This highlights the dilation button on the toolbar.
 - (3) Tap the center of dilation.
 - This displays the Dilation dialog box.
 - (4) Specify the dilation scale factor.

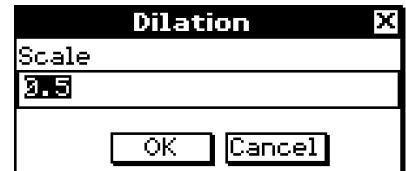

- (5) Tap [OK].

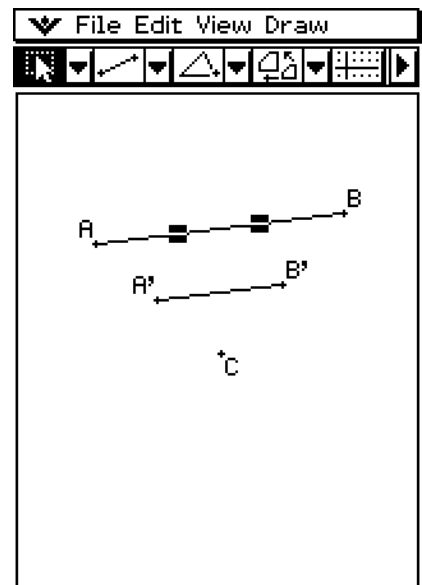

Transformation Using a Matrix or Vector (General Transform)

General Transform lets you input a matrix and/or vector to transform a figure. The result of the transformation is drawn as a separate figure. For example, if you transform line segment AB, the line segment A'B' will be drawn.

You can perform the following types of transformations with General Transform.

- Matrix Transformation: x -axis/ y -axis symmetry, rotation, enlargement, reduction, etc.
- Vector Transformation: Vertical and horizontal parallel displacement

■ **General Transform Example**

In this example draw triangle ABC and then draw triangle A'B'C', which is symmetrical to ABC about the x -axis. Next, we will draw triangle A''B''C'' by performing a parallel displacement on triangle A'B'C' of 1 unit along the x - and y -axis.

Tip

- All of the steps in the procedure below are performed using the Geometry application only. You can also use the Main application or eActivity application to perform matrix calculations and obtain the same transformation. You can drag a figure from Geometry to Main, which transforms values (matrix) and performs calculation, and drag the values (matrix) obtained as a result from Main to Geometry to draw the transformed figure. After performing the following procedure, see “Transform Example Using the Main Application” (page 8-2-40).

If you need to, tap [Edit] and then [Clear All] before beginning this example.

• **ClassPad Operation**

- (1) Tap  to turn on coordinate display in the Geometry window.
 - You can skip this step if you want, but turning on coordinate display helps you see how coordinates are changed by the transform operations.
- (2) Draw triangle ABC, and then select its three sides.

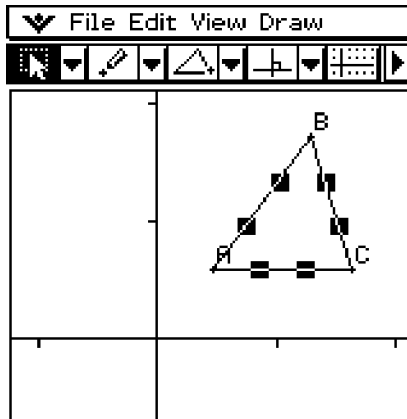

- (3) Tap [Draw], [Construct], and then [General Transform].
 - This displays the Transform dialog box.
- (4) Since we want a triangle that is symmetrical about the x -axis to the original triangle, input $[[1, 0], [0, -1]]$.

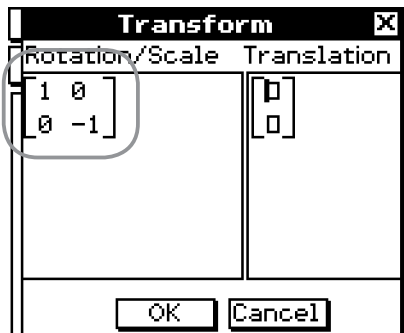

(5) Tap [OK].

- This draws triangle A'B'C', which is symmetrical to triangle ABC about the x -axis.

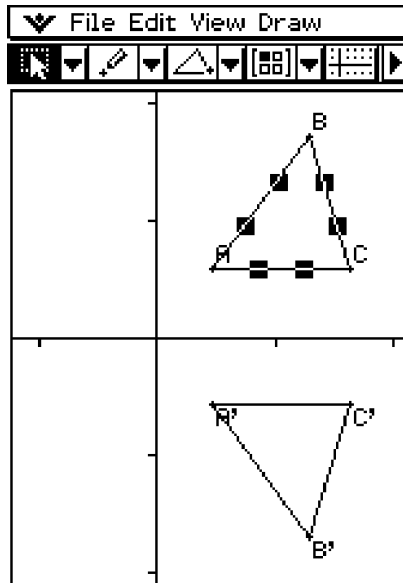

(6) Tap anywhere outside of the triangles to deselect the currently selected triangle. Next, select triangle A'B'C'.

(7) Tap [Draw], [Construct], and then [General Transform].

(8) Now, to perform parallel displacement on triangle A'B'C' by 1 unit along the x - and y -axis, input [1, 1].

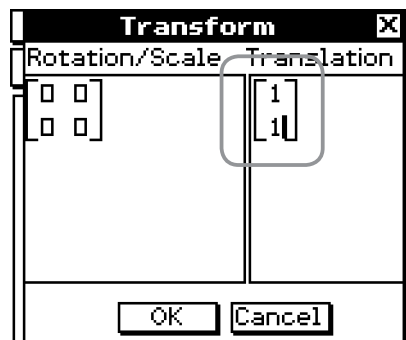

(9) Tap [OK].

- This performs the parallel displacement and draws triangle A''B''C''.

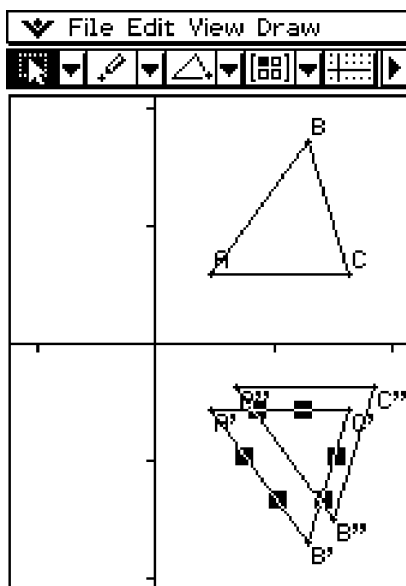

Note

- In the above example, we performed the transformation and the parallel displacement operations separately. You could also perform both operations at the same time, if you want. To do so, input both the matrix $\begin{bmatrix} 1 & 0 \\ 0 & -1 \end{bmatrix}$ and the vector $[1, 1]$ in step (4), and then tap [OK]. This will produce the result shown in step (9).

■ Transform Example Using the Main Application

It might be easier to understand how General Transform works if you use the Main application (or eActivity application) in combination with the Geometry application. This makes it possible to perform the following types of operations.

- In the Geometry application, you can select a point on the figure obtained using General Transform and the corresponding point on the original figure (for example, point A on the original figure and point A' on the transformed figure), drag them to the Main application, and display the transformation expression in the Main application.
- You can select a triangle in the Geometry application and drag it to the Main application to convert the triangle to a matrix (2-row \times 3-column matrix that shows three vertices). Conversely, you can drag a 2-row \times 3-column matrix input (or produced by a calculation) in the Main application to the Geometry application and draw the applicable triangle.

Here we will show actual examples of (a) and (b).



Tip

- All of the above operations can also be performed using the eActivity application instead of the Main application.
- For information about how to access the Geometry application from the Main application and about the different operations you can perform between them, see “2-10 Using the Main Application in Combination with Other Applications”.

■ (a) Operation Example

The following procedure assumes that the results produced by the procedure under “General Transform Example” on page 8-2-37 are still on the Geometry application window.

● ClassPad Operation

- (1) On the application menu, tap  to start up the Main application.
- (2) Tap the right most down arrow button on the Main application toolbar. On the button list that appears, tap .
 - This opens the Geometry application and displays triangles ABC, A'B'C', and A''B''C'' on the Geometry window.

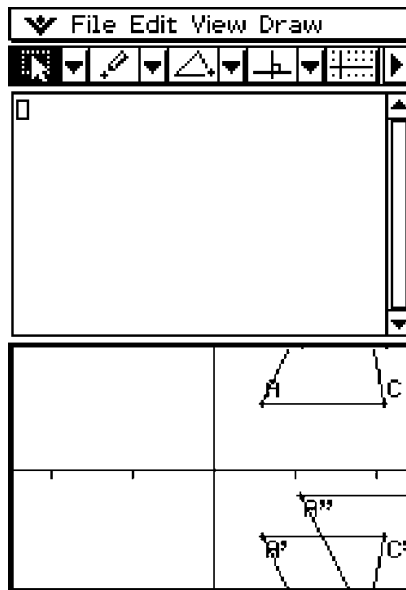

- (3) Select points A and A'.
- (4) While both points are selected, drag point A (or point A') to the cursor position in the Main application work area.
 - This displays the expression that transformed the coordinates of point A to the coordinates of point A'.

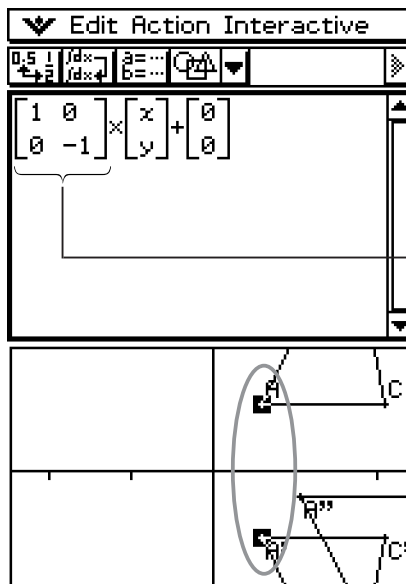

Observe this area of the expression. This corresponds to the matrix values you input when executing General Transform.

- (5) After clearing the Main application work area, try repeating steps (3) and (4) for points A' and A''.
- This displays the expression that transformed the coordinates of point A' to the coordinates of point A''.

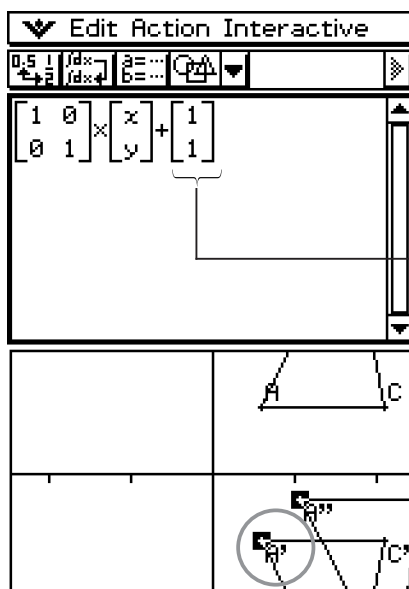



Observe this area of the expression. This corresponds to the vector values you input when executing General Transform.

Important!

- This operation is valid only when a point in the original figure and the corresponding point in the transformed figure are selected in the Geometry application. Nothing is displayed when you select points A and A'' in the above procedure and drag them to the Main application work area.

■ (b) Operation Example

• ClassPad Operation

- (1) On the application menu, tap  to start up the Main application.
- (2) Tap the right most down arrow button on the Main application toolbar. On the button list that appears, tap .
 - This opens the Geometry application.
- (3) On the Geometry window, tap [Edit] and then [Clear All].
 - This clears the Geometry window.
- (4) Draw a triangle on the Geometry window.
 - After drawing a triangle, you can use the measurement box (page 8-3-6) to adjust the coordinates of points A, B, and C. That will make the following steps easier.

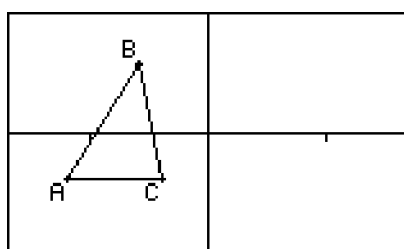

- (5) Select the triangle and drag it to the cursor location in the Main application work area.
- This inputs a matrix that shows the coordinates of the triangle's three vertices into the work area.

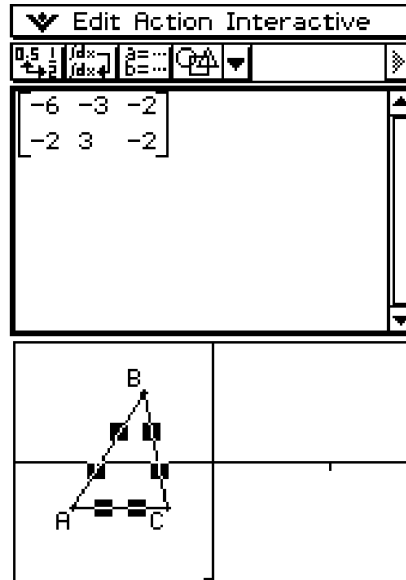

- (6) Here, try multiplying by the matrix $\begin{bmatrix} -1 & 0 \\ 0 & 1 \end{bmatrix}$ to transform the matrix obtained above to a form that is symmetrical about the y -axis. Execute the calculation as shown in the screenshot below.

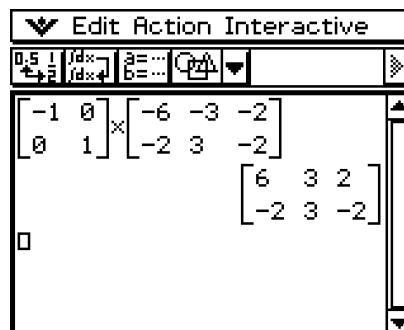

(7) Select the matrix obtained as the calculation result, and drag it to the Geometry window.

- This draws a triangle that is symmetrical to the original triangle about the y-axis.

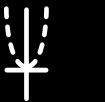
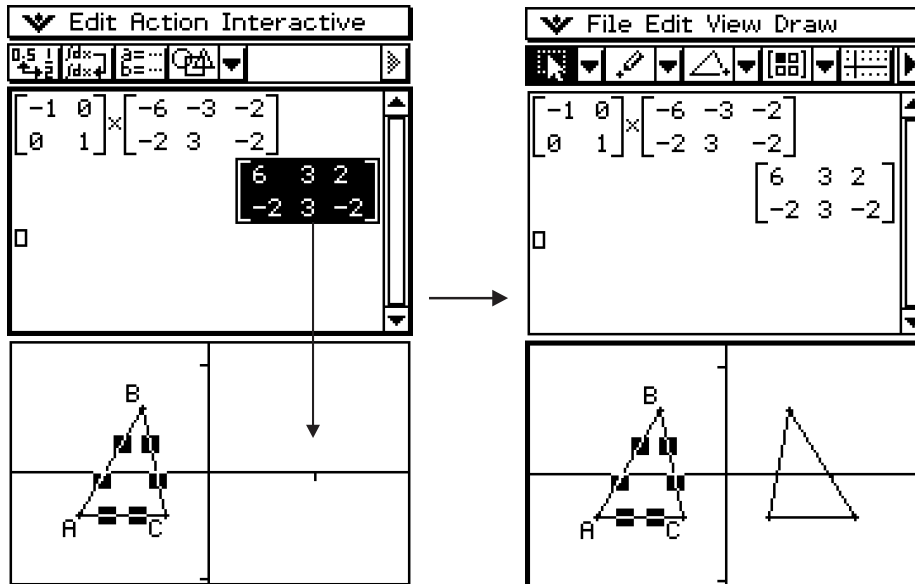

8-3 Editing Figures

This section provides details about moving, copying, and deleting Geometry application figures.

Selecting and Deselecting Figures

Before you can execute certain editing commands, you must first select the figure you want to edit. There are two figure selection modes: Select and Toggle Select, each of which is described below.

■ Using Select

Tap  on the toolbar. This causes the button to become highlighted, indicating that Select is enabled. Select allows you to select as many figures as you would like, and then move, copy, paste, or perform other operations on the selection as a single entity.

- To select side BC of the triangle, tap it.

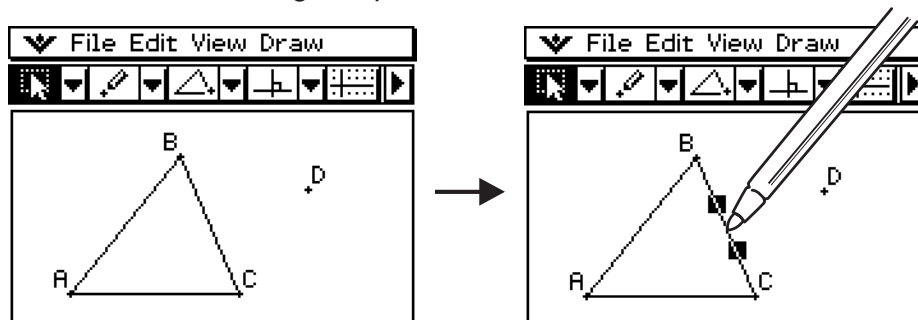

- Tapping point D selects it, leaving side BC of the triangle selected, too.

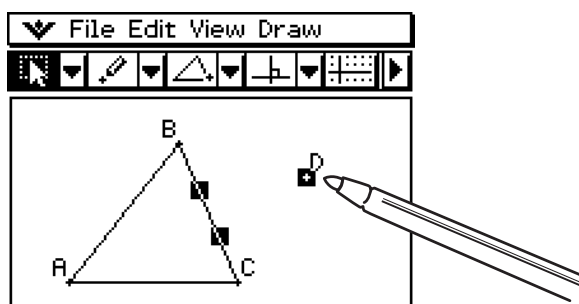

- To deselect all of the figures, tap anywhere on the screen where there are no figures.

Tip

- When Select is enabled, you can drag the currently selected figures to move them around the display. For more information, see “Moving and Copying Figures” on page 8-3-3.

■ Using Toggle Select

Tap  on the toolbar. This causes the button to become highlighted, indicating that Toggle Select is enabled. Toggle Select allows you to select and deselect figures. For example, if you have multiple figures selected, Toggle Select will allow you to deselect a single part of the selection. Tapping the part again will turn the selection back on.

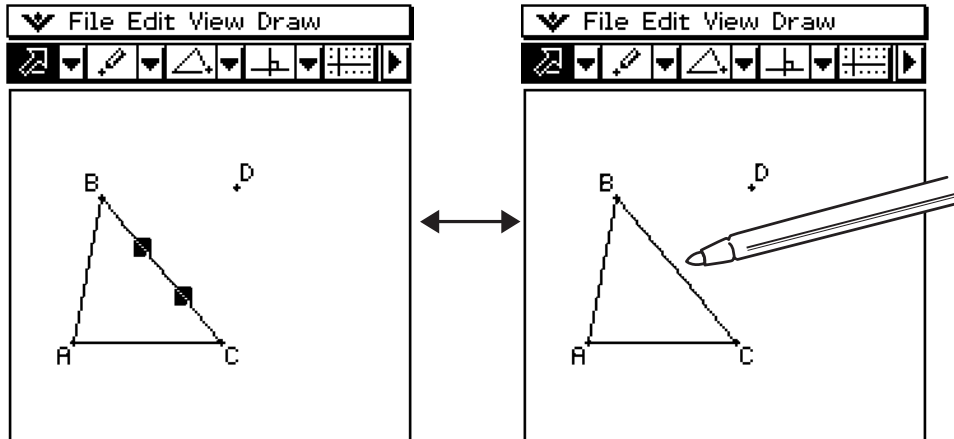

Tip

- You cannot move figures around the window while Toggle Select is enabled. Also, the currently selected figure does not become deselected if you tap an area of the window where there is no figure. To move what you currently have selected, simply change to the regular Select mode.



Moving and Copying Figures

It is easy to move figures or copy and paste figures in Geometry.

• To move a figure

- (1) Draw a figure.
- (2) Tap , and then select the figure.
- (3) Drag the figure to move it to the location you want.
- (4) Remove the stylus from the screen.

Tip

- Note that a selection boundary appears around the figure when you drag it.

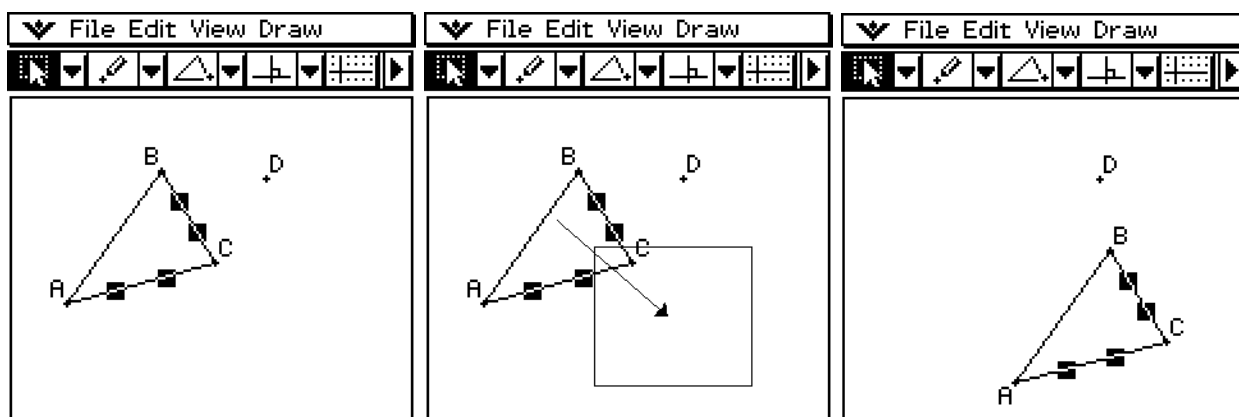

• To copy a figure

- (1) Draw a figure, and then select it.
- (2) Tap [Edit], and then [Copy].
- (3) Tap anywhere on the screen to deselect the figure.
- (4) Tap [Edit], and then [Paste].
- (5) Drag the pasted figure to the location you want.

Pinning an Annotation on the Geometry Window

You can pin an annotation on the Geometry window using the Pin function. By default, annotations are 'Unpinned', so they pan or zoom along with the Geometry window. Pinning an annotation fixes its position on the screen so it is always displayed in the same location on the Geometry window.

Example: To pin text at a particular location on the Geometry window

(1) Select (highlight) the text on the Geometry window.

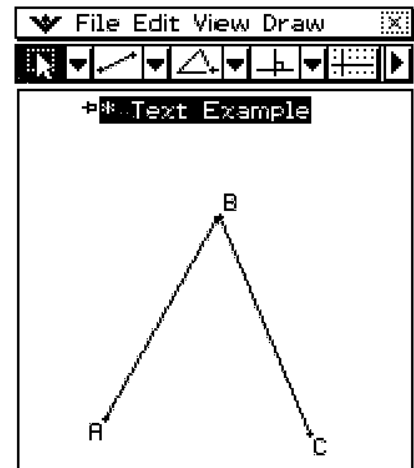

(2) Tap [Edit], [Properties], and then [Pin].

(3) When text is pinned, it maintains its position as shown here even when the window is panned.

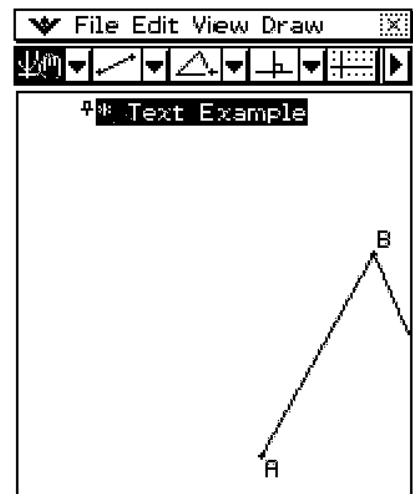

Specifying the Number Format of a Measurement

You can specify the number format for each measurement on the Geometry window.

Example: To specify zero decimal places for measurement values on the Geometry window

(1) Select (highlight) the measurement(s).

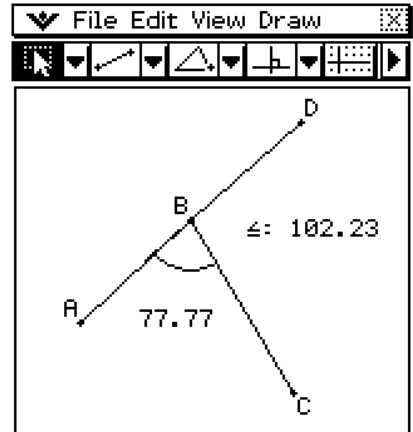

(2) Tap the [Edit], [Properties], and then [Number Format].

- This displays the Number Format dialog box as shown here.

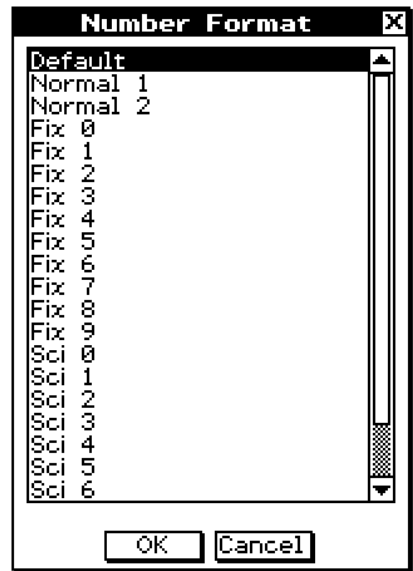

(3) Select the number format you want by tapping it. Since we want to specify zero decimal places, we will select “Fix 0” here.

- For the meaning of each number format name, see “Number Format” on page 1-9-5.

(4) Tap [OK].

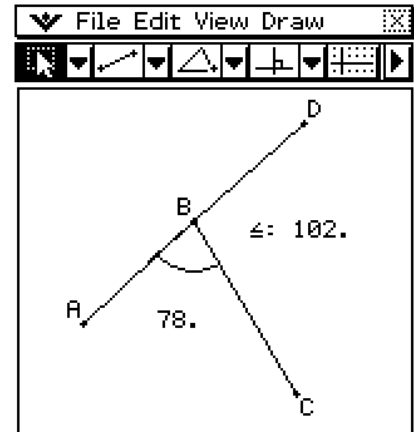

- This will display the measurement value(s) you selected in the step 1 using the specified number format.



Tip

The initial default number format setting for measurement values is “Fix 2”.

Using the Measurement Box

Tapping the  button to the right of the toolbar displays the measurement box. Tap  to return to the normal toolbar.

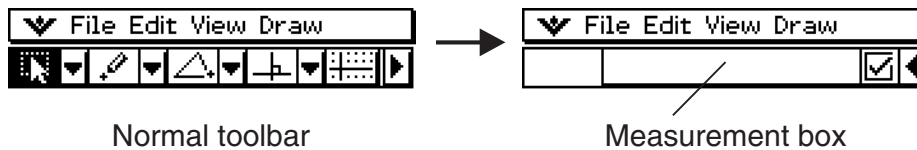

You can use the measurement box to perform the following operations.

View the measurements of a figure

Displaying the measurement box and selecting a figure displays combinations of the following measurements, depending on the type of object you select: coordinates, distance, slope, direction, equation, radius, circumference, area, perimeter, angle, tangency, congruence, incidence, or point on curve.

Specify a measurement of a figure

After you display the measurement box, you can select part of a figure and then change numeric values for the applicable measurement. You can specify the coordinates of a point, the length of a line segment (distance between endpoints), the angle formed by two lines, etc.

Fix a measurement of a figure

After you display the measurement box, you can select part of a figure and then fix the applicable measurement. You can fix the coordinates of a point, the length of a line segment, the angle formed by two lines, etc.

Name a figure

After you display the measurement box, you can select part or all of a figure and then give it a name or change the existing name. You can name a point, line segment, circle, attached angle, etc.





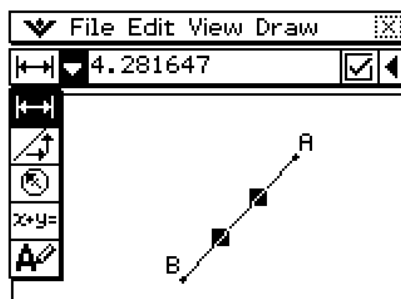

■ Viewing the Measurements of a Figure

The type of information that appears in the measurement box depends on the figure that is currently selected on the display. If a line segment is selected, for example, the measurement box shows the distance, slope, angle from the x -axis, and the equation for that line. You can specify the type of information you want to view by tapping the down arrow button to the left of the measurement box, and then tapping the appropriate icon on the icon palette that appears.



The following table describes the information that appears when you tap each icon, and explains when each icon is available for selection.

Icon	Icon Name	This icon appears when this is selected:	Tapping this icon displays:	Lockable
	Coordinates	A single point	Coordinates of the point	Yes
	Distance/ length	Two points on one figure or two different figures, or a single line segment or a vector	Distance between two points, length of a line segment or vector	Yes
	Slope	Single line, line segment, or vector	Slope of the line, line segment or vector	Yes
	Direction	Single line, line segment, or vector	Direction angle of the line (angle of inclination)	Yes
	Equation	Any single line or line segment, vector, circle, arc, ellipse or any other figure (parabola, etc.) drawn by a function	Function of the figure (using rectangular coordinates)	Yes
	Equation edit	Single parabola or any other figure drawn by a function	Equation of the figure in the function editing dialog box.	No
	Radius	Single circle or arc	Radius of circle or arc	Yes
	Circumference	Single circle, arc or ellipse	Length of the circumference	Yes
	Perimeter	Single polygon	Sum of the lengths of the sides	No
	Area	Any three points, a single circle, arc, ellipse, or polygon	Area	No

Icon	Icon Name	This icon appears when this is selected:	Tapping this icon displays:	Lockable
	Angle	Two line segments	Angle and its supplement formed by the line segments	Yes
	Tangency	Two circles or arcs, or a line and circle	Whether two items are tangent	Yes
	Congruence	Two line segments	Whether line segments are the same length	Yes
	Incidence	Point and a line, arc, circle or a vector	Whether a point is on the line/curve	Yes
	Point on curve	Point and a function, curve, or ellipse		
	Rotation angle	Two points created by [Rotation]	Angle of rotation	*1
	Scale of dilation	Two points (like Point A and Point A') on a figure created by [Dilation]	Scale of dilation	*1
	Text icon	An object that includes text or an object that can be named	Editable text used to name the selected image	No

*1 The value in the measurement box is always locked while this tool is selected.

You can use the measurement box to determine certain measurements.

In the first example below, three points are selected on the screen and the measurement box shows the area of the triangle formed by them.

The second example shows how to view the measurements of a line segment.

● To display the area of a triangular area

You can use the measurement box to display the area of a triangle formed by any three points you select on the display.

Example: To use the parallelogram ABCD, in which sides AD and BC are parallel, to determine the areas of the triangles formed by side AD and point B, and side AD and point C

(1) Draw the parallelogram.

- If you need to, select [Edit] and then [Clear All] before beginning this example.

(2) Tap  on the toolbar to display the measurement box.

(3) Select points A, D, and B.

- This causes the area of the triangle ADB to appear in the measurement box.

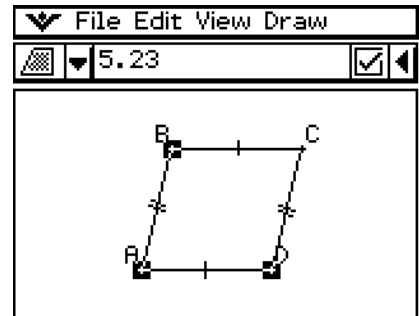

(4) Tap anywhere outside of the parallelogram to deselect the current points, and then select points A, D, and C.

- This causes the area of the triangle ADC to appear in the measurement box. The above procedure shows that the areas of the two triangles are the same.

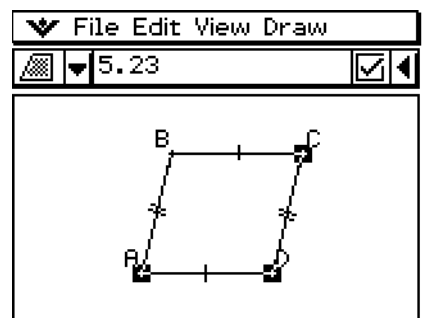

• **To view the measurements of a line segment**

(1) Draw a line segment.

(2) Tap  on the toolbar to display the measurement box.

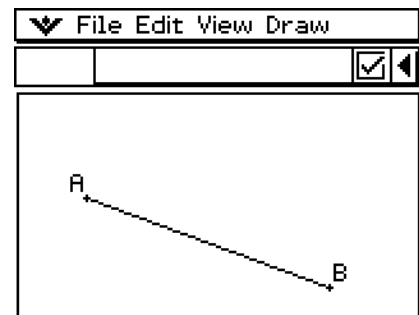

(3) Select the line segment.

- This displays the length of the line segment.

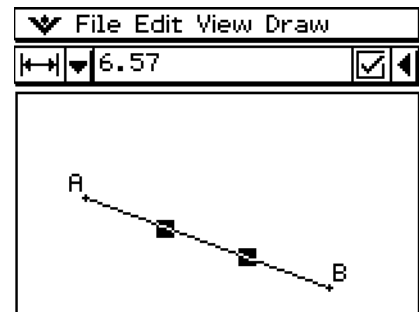

(4) Tap the down arrow next to the measurement box to cycle through other measurements.

- In the case of the line segment, for example, you can view its length, slope, direction, and equation.

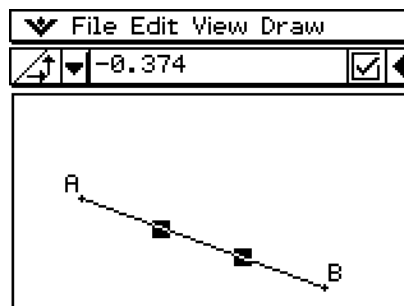
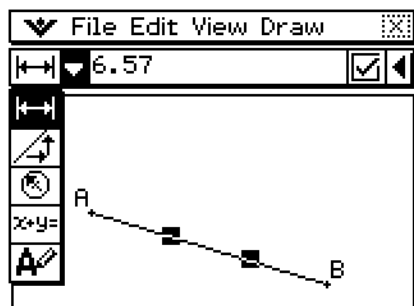

■ Specifying a Measurement of a Figure

The following example shows how to specify an angle of a triangle.

• To specify the angle of a triangle

- (1) Check to make sure the [Measure Angle] setting of the Geometry Format dialog box is set to "Degree" (see page 1-9-10 for more information).
- (2) Draw the triangle.
 - If you need to, select [Edit] and then [Clear All] before beginning this example.
- (3) Tap  on the toolbar to display the measurement box.
- (4) Select side AB and then select side BC.
 - This displays the measure of angle B in the measurement box.

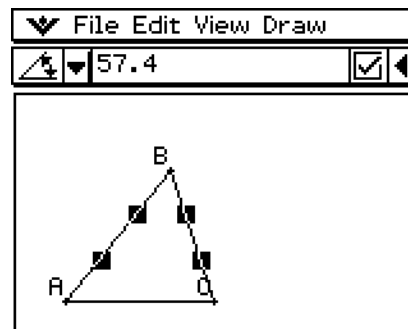

(5) Input the value you want to specify for angle B into the measurement box and press .

- In this example, we input 90, which makes angle B 90 degrees.

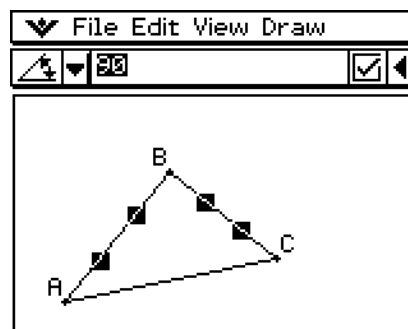

■ Fixing a Measurement of a Figure

By “fixing a measurement” we mean that a constraint is placed on the figure. For example, if we fix (constrain) a point to a circle and move the circle, the point will also move. The following example shows how to fix the size of an angle of a triangle.

● To fix the measure of an angle of a triangle

- (1) Draw the triangle.
- (2) Select side AB and then select side BC.
- (3) Input 90 into the measurement box, and then select the check box to the right of it.
 - This fixes the measure of angle B at 90 degrees.

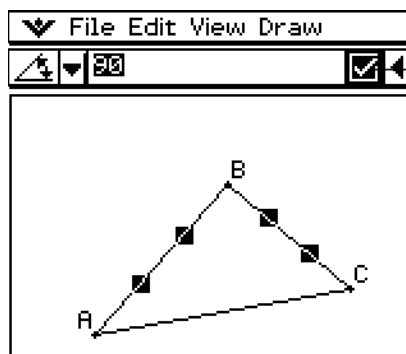

A highlighted check box indicates the measurement is fixed (constrained).

■ Changing a Label or Adding a Name to an Element

You can change the name of a point, or add a name to each element as explained in the following example.

● ClassPad Operation

- (1) Select (highlight) a point. Tap the down arrow to the right of icon palette on measurement box and then .
- This displays the current name of point A in the measurement box. The displayed name is highlighted so it can be edited.

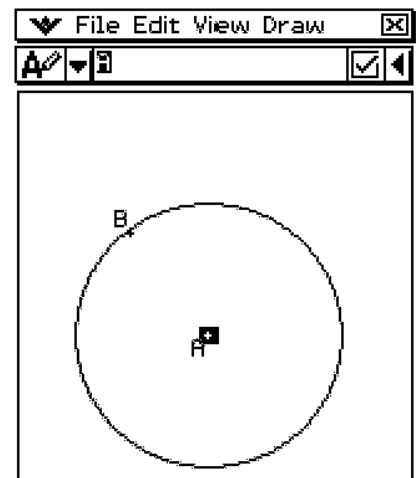

8-3-12
Editing Figures

(2) Input a new name ("Center") in the measurement box.

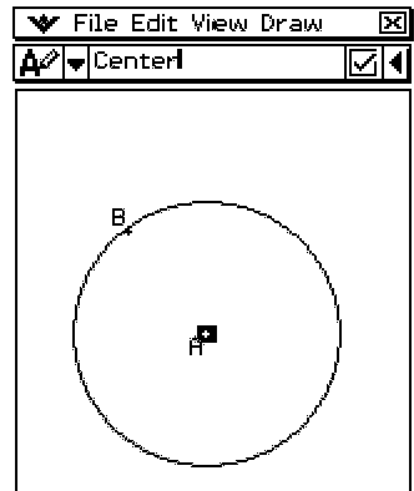

(3) Tap **EXE** or the check box to the right side of measurement box.

- This displays the changed name on the screen as shown here.

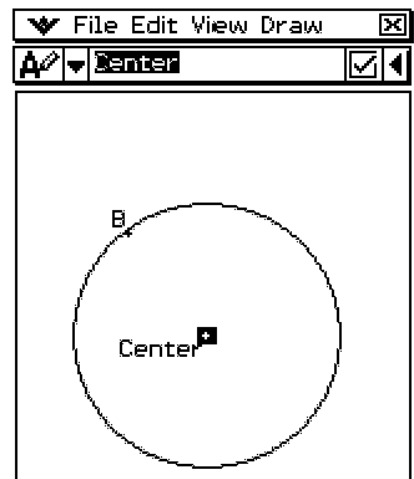

8-4 Controlling Geometry Window Appearance

This section provides information about how to control the appearance of the Geometry application window by scrolling or zooming, and by showing or hiding axes and the grid.

Configuring View Window Settings

You can use the following procedures to configure settings that control the appearance of the Geometry application window.

Tap , and then [View Window] to display the View Window dialog box. The View Window dialog box allows you to configure the x -axis range of values. The y_{mid} value is used to center the Graph window vertically. For example, if we set $y_{mid} = 2$, then the y -axis will appear 2 units below the center of the Graph window.

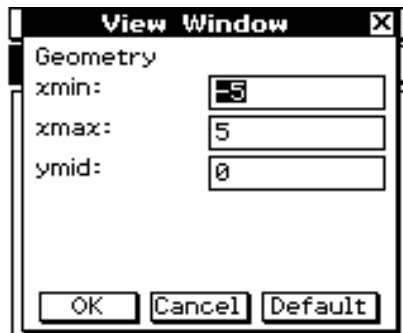

Selecting the Axis Setting

Tap , or tap [View] and then [Toggle Axes] to cycle through the four settings shown below.

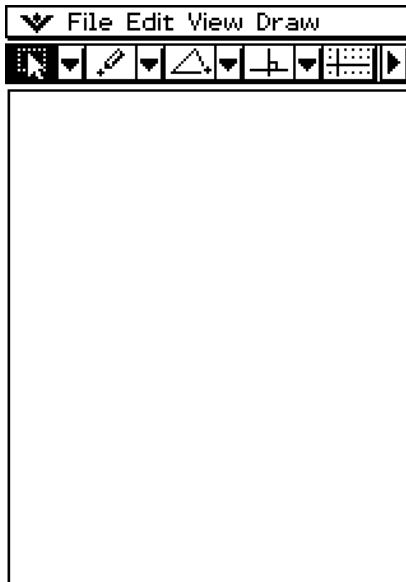

Axes off, values off

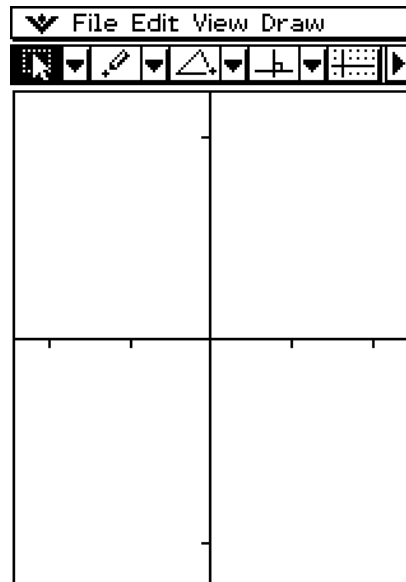

Axes on, values off

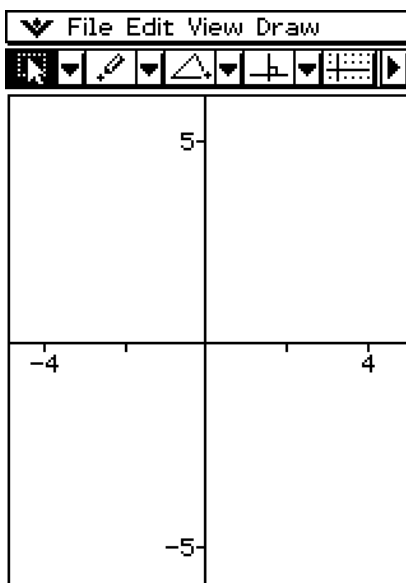

Axes on, values on

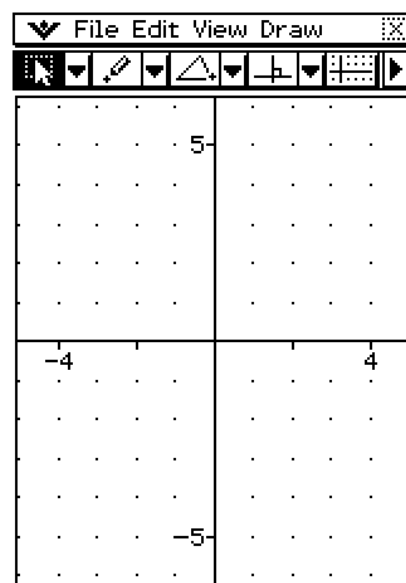

Axes on, values on and grid on

Tip

- You can also turn on the Integer Grid by tapping [View] and then [Integer Grid]. See page 8-4-3 for more information.

toggling Integer Grid Display On and Off

You can toggle integer grid display on and off by tapping [View] and then [Integer Grid]. The [Integer Grid] command on the [View] menu has a check mark next to it while integer grid display is turned on.

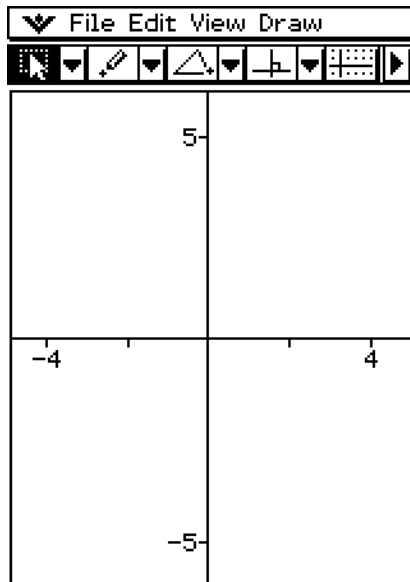

Grid off

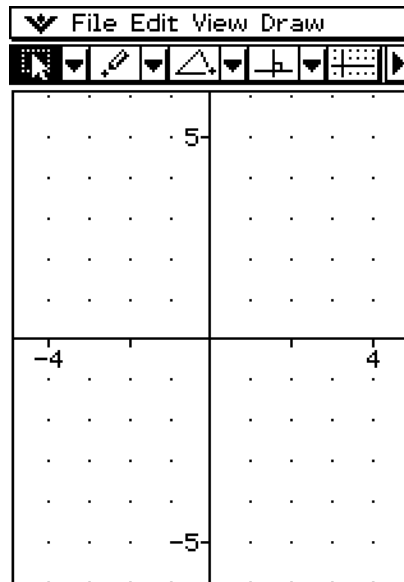

Grid on

Zooming

The Geometry application provides you with a selection of zoom commands that you can use to enlarge or reduce an entire display image or a specific area of a figure.

Tip

- The screenshots in this section all use the “Axes on, values on” setting described under “Selecting the Axis Setting” on page 8-4-2.

• To use Zoom Box

Example: To use zoom box to enlarge part of a circle

- (1) Draw a circle.
- (2) Tap [View] and then [Zoom Box], or tap .
- (3) Drag the stylus on the screen to draw a selection boundary around the area you want to enlarge.

- (4) Remove the stylus from the display and the area within the selection boundary expands to fill the entire Graph window.

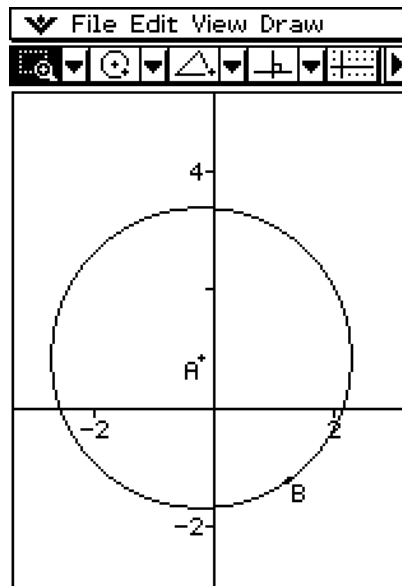
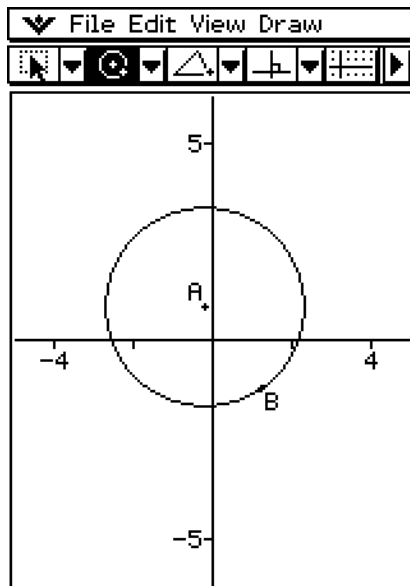

• To use Zoom In and Out

Example 1: To zoom in on a circle

- (1) Draw a circle.
- (2) Tap [View] and then [Zoom In], or tap .

 - This enlarges the circle.

Example 2: To zoom out on a circle

- (1) Draw a circle.
- (2) Tap [View] and then [Zoom Out] or tap .

 - This reduces the size of the circle.

- **To use Zoom to Fit**

(1) Draw the figure or figures you want.

- If what you are drawing does not fit on the display, scroll the image as you draw it.
- For information about scrolling the screen, see “Using Pan to Shift the Display Image” on page 8-4-6.

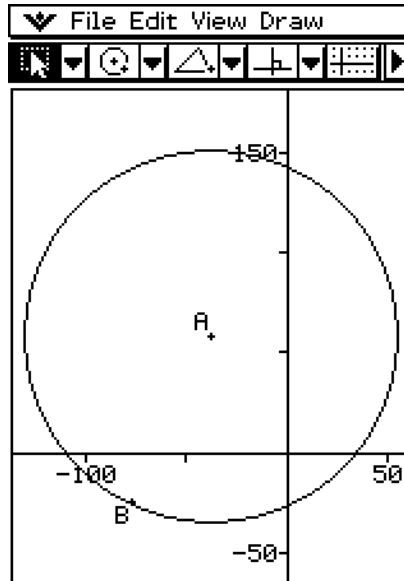
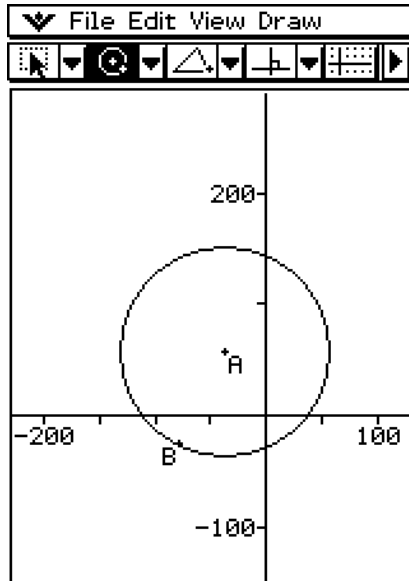

(2) Tap [View] and then [Zoom to Fit], or tap .

- This enlarges or reduces the figure so it fills the display.



Tip

- You can also perform the Zoom In, Zoom Out, and Zoom to Fit operations by pressing ClassPad keys as described below.

To do this:	Press this key:
Zoom In	
Zoom Out	
Zoom to Fit	

Using Pan to Shift the Display Image

Panning makes it easy to shift the display image by dragging with the stylus.

Tip

- The screenshot in this section uses the “Axes on, values on” setting described under “Selecting the Axis Setting” on page 8-4-2.

• To use Pan

Example: To pan the image of a circle

- Draw a circle.
- Tap [View] and then [Pan], or tap .
- Place the stylus on the screen and drag in the direction you want to shift the image of the circle.

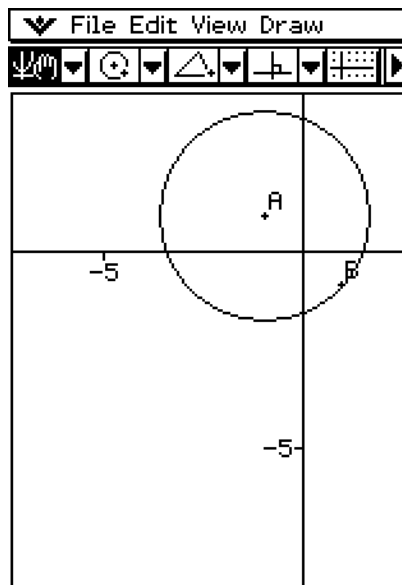
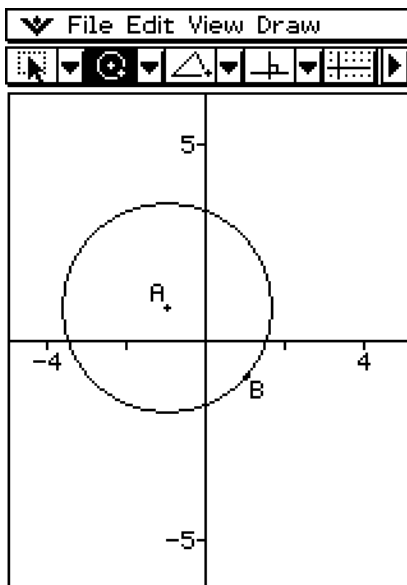

Tip

- You can also scroll the window using the cursor keys.

8-5 Working with Animations

An animation consists of one or more point/curve pairs, in which the curve can be a line segment, circle, ellipse, or function. You build an animation by selecting a point/curve pair, and then adding it to an animation.

Using Animation Commands

You can build and run an animation either by executing menu commands or by using the animation toolbar that appears when you tap [View] and then [Animation UI].

[Edit] – [Animate]

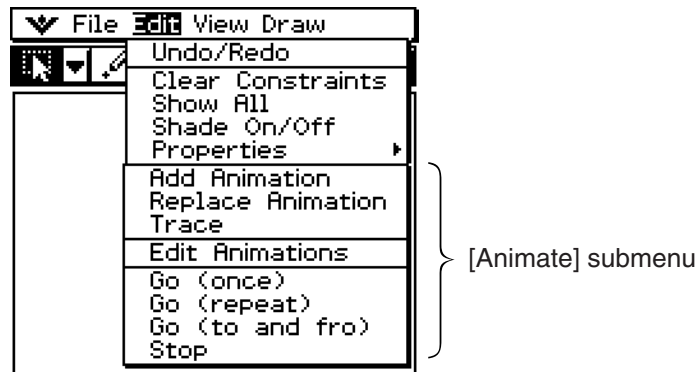

[View] – [Animation UI]

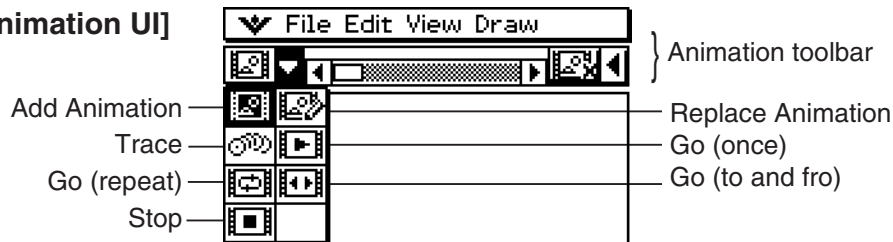

Tip

- Most of the procedures in this section are performed using the [Animate] submenu.
- All of the [Animate] menu commands can be accessed from the animation toolbar, except for [Edit] - [Animate] - [Edit Animations].
- To close the animation toolbar and return to the normal toolbar, tap the  button on the right side of the animation toolbar, or tap [View] and then [Animation UI].

• **To add an animation and run it**

- (1) Plot a point and draw an arc. Or, you could draw a circle, ellipse, line segment, or function instead of an arc.
- (2) Select the point and arc.

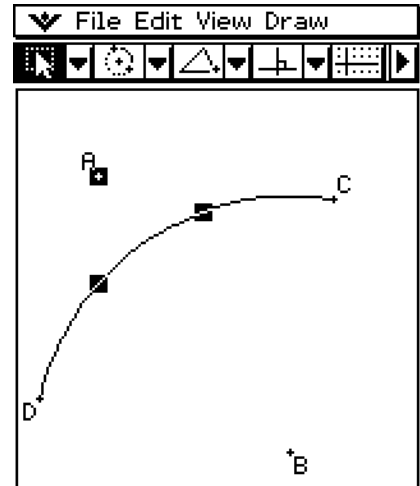

- (3) Tap [Edit], [Animate], and then [Add Animation].

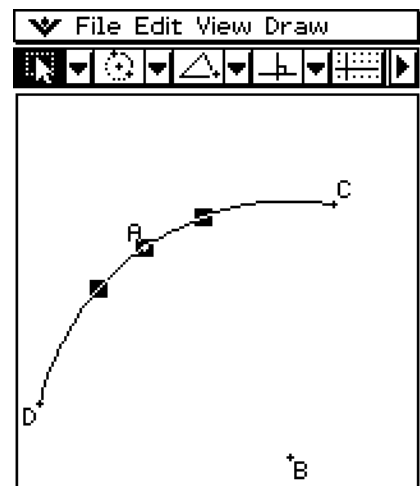

- (4) Tap [Edit], [Animate], and then [Go (once)], [Go (repeat)], or [Go (to and fro)].

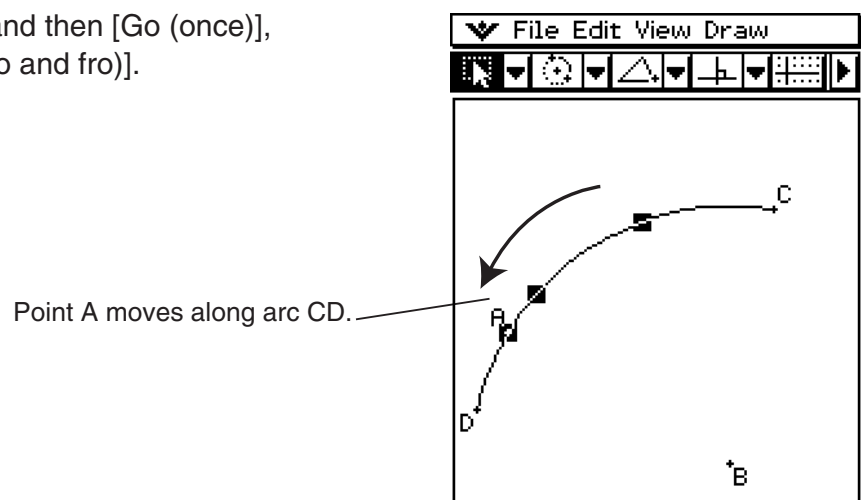

- (5) Tap [Edit], [Animate], and then [Stop] to stop the animation.

- You can also stop the animation by tapping **ESC** on the icon panel.

Tip

- You can repeat the above procedure to create multiple points that move simultaneously.

Try this:

- Draw a line segment and plot another point.
- Select the line segment and the point.
- Repeat steps (3) and (4) on page 8-5-2.

Notice that both animations go at the same time!

- To start a new animation, perform the procedure under “To replace the current animation with a new one” on page 8-5-4. Or, tap [Edit], [Animate] and then [Edit Animations]. On the dialog box that appears tap [Remove].

- To animate a point around a circle**

(1) Plot a point and draw a circle, and then select them.

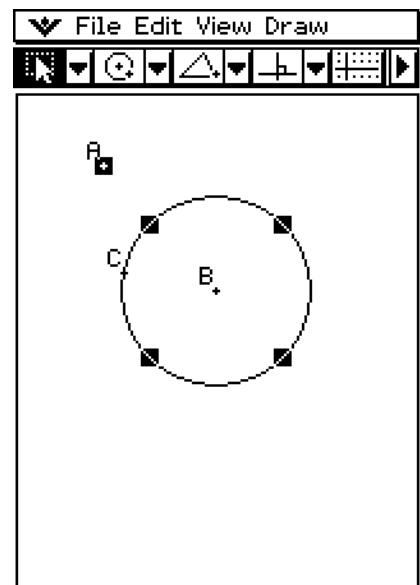

(2) Tap [Edit], [Animate], and then [Add Animation].

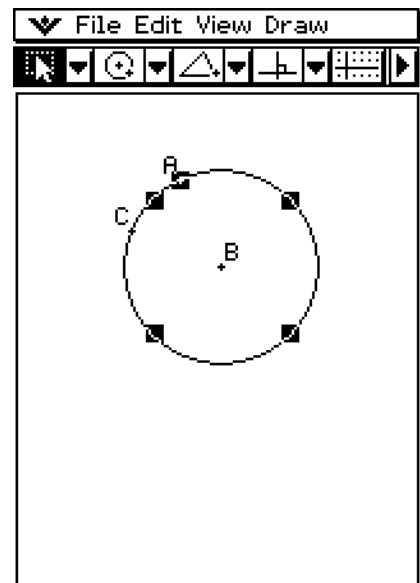

(3) Tap [Edit], [Animate], and then [Go (once)].

- This causes the point to travel around the circumference of the circle.

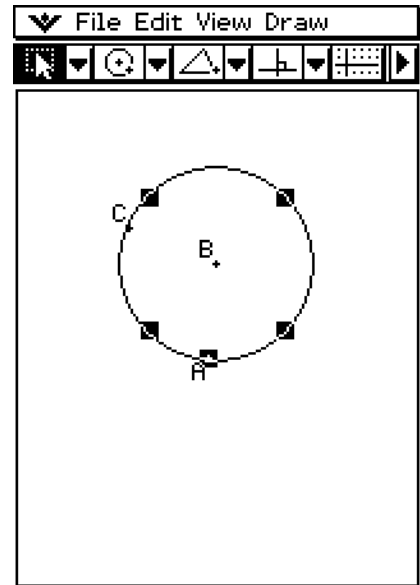

• **To replace the current animation with a new one**

(1) Select the point and curve for the new animation.

(2) Tap [Edit], [Animate], and then [Replace Animation].

- This discards the currently set animation and sets up an animation for a new point and curve set. Tap [Edit], [Animate], and then [Go (once)] to see your new animation.

• **To trace a locus of points**

Tip

- Using trace leaves a trail of points when the animation is run.

(1) Draw a line segment AB and plot point C, which is not on line segment AB.

(2) Plot point D, which should also not be on line segment AB, but should be on the same side of the line segment as point C.

(3) Draw a line segment that connects point D with point C.

(4) Draw another line segment that connects point D with line segment AB. This is line segment DE.

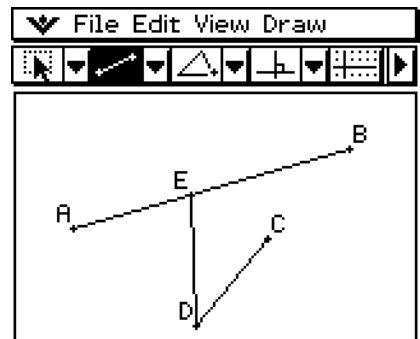

(5) Tap the right arrow button to display the measurement box.

(6) Select line segments AB and DE, enter 90 in the measurement box, and tap the check box next to the measurement box.

- This fixes the angle between AB and DE at 90 degrees.

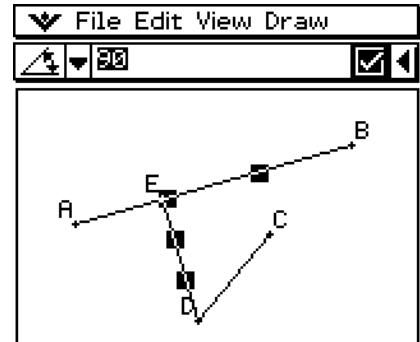

(7) Select only line segments DE and DC, and then tap the down arrow next to the measurement box.

(8) Tap the  icon, and then select the check box to the right of the measurement box.

- This makes line segments DE and DC congruent in length.

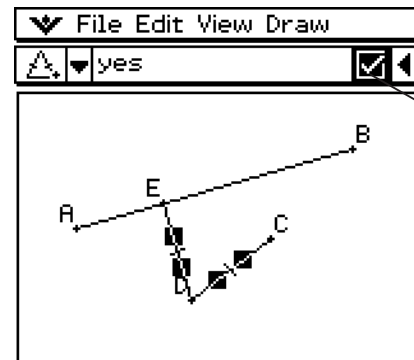
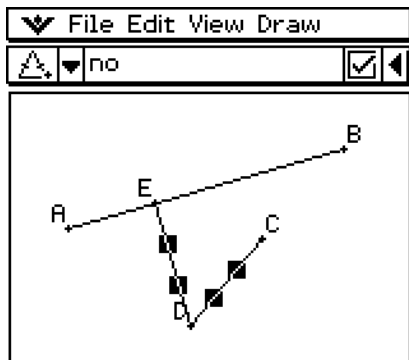

A highlighted check box indicates the measurement is fixed (constrained).

(9) Select point E and line segment AB.

(10) Tap [Edit], [Animate], and then [Add Animation].

(11) Tap the screen to deselect the currently selected items.

(12) Select point C.

(13) Select the check box to the right of the measurement box.

- This fixes the position of point C.

(14) Select point D.

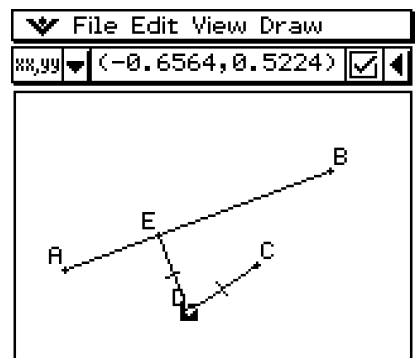

(15) Tap [Edit], [Animate], and then [Trace].

- This should cause a parabola to be traced on the display. Note that line segment AB is the directrix and point C is the focus of the parabola.

(16) With point D still selected, tap [Edit], [Animate], and then [Go (once)].

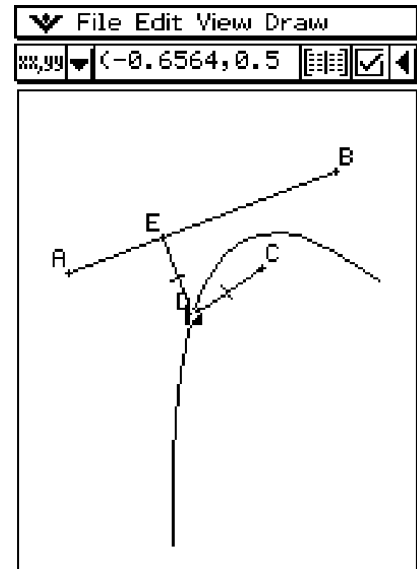

• To edit an animation

(1) While the animation you want to edit is on the display, tap [Edit], [Animate], and then [Edit Animations].

- This displays the animation editing window in the lower window. The upper window contains the animation that we just completed in “To trace a locus of points”. See page 8-5-4 for information about specifying the trace point.

(2) Edit the animation following the procedure below.

Steps

This setting specifies how many steps point E takes to move along line segment AB. The initial default value is 20.

Animations

- The “E” under “Animations” indicates that point E is the point moved by the animation. When you are building multiple animations, a list of all applicable points appears here.
- Tapping [Remove] deletes the applicable animation.
- “t0” and “t1” specify the range of movement of point E on line segment AB. The initial default values are $t_0 = 0$ and $t_1 = 1$.
- During animation, the length of AB is considered to be one unit. The default values specify that movement of point E is from start point A (point where length equals 0) up to end point B (point where length equals 1).
- Changing the value of t_0 to 0.5, for example, causes point E to move from the middle of line segment AB to point B.
- Changing the value of t_0 to -1 , causes point E to begin at a point outside line segment AB (in this case, at a point a distance equivalent to the length of line segment AB) and ending with point B.

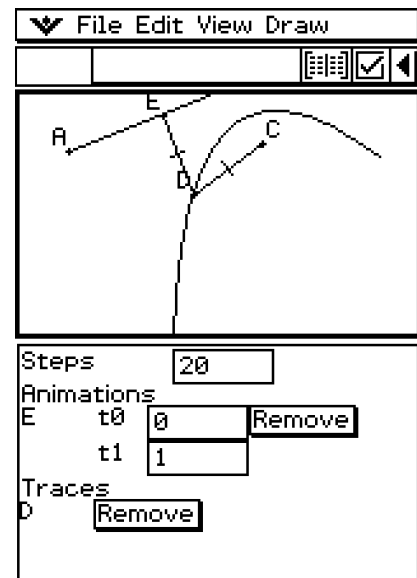

Traces

This item shows the specified trace point. Tapping [Remove] cancels the trace point setting.

- (3) While the lower window is active, tap  and then [Close] to close the animation editing window.

• **To view an animation table**

- (1) Draw a triangle and a line segment above the triangle.
 (2) Tap the right arrow button to display the measurement box.
 (3) Select the line segment and the vertex point closest to the line.

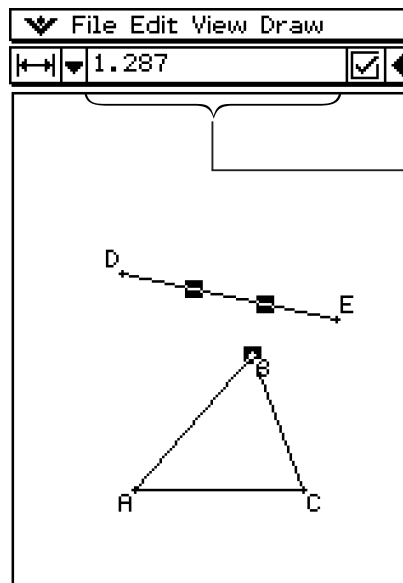

Measurement box

- (4) Tap the down arrow next to the measurement box.
 (5) Tap the  icon, and then select the check box to the right of the measurement box.
- This connects the segment and vertex point.

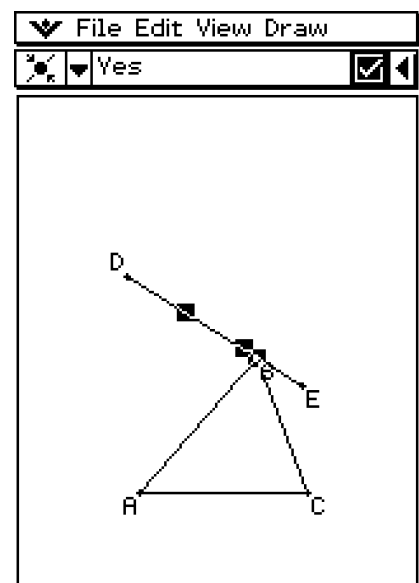

(6) With the line and vertex point still selected, tap [Edit], [Animate], and then [Add Animation].

(7) Now, select only one side of the triangle.

(8) Tap [Edit], [Animate], and then [Go (once)].

(9) Tap  next to the measurement box.

- While the animation is running, the lower window shows the table for the length of the side you selected.

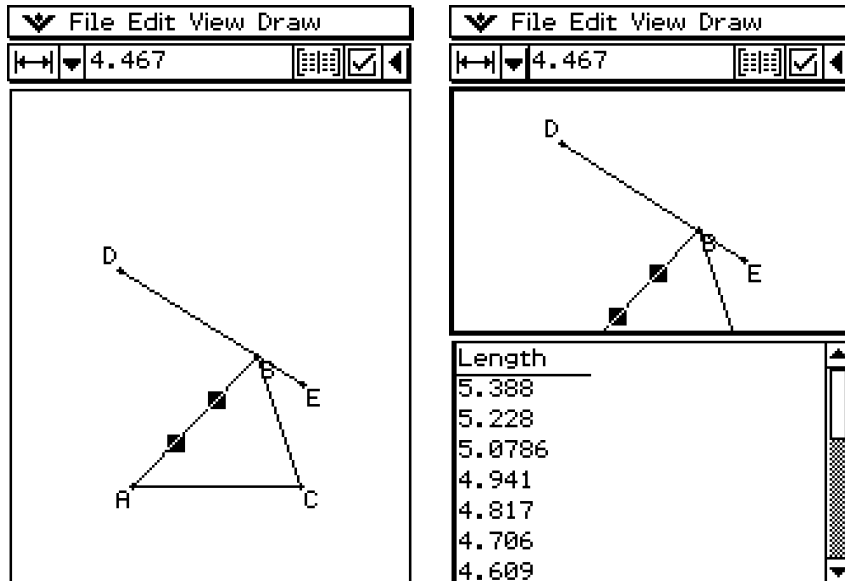

(10) Try selecting another side and running the animation again to view the table for that side. Or, select another side and tap .

(11) Select all three sides of the triangle and run the animation again.

- The table that appears in the lower window will show how the area of the triangle changes while the animation runs.

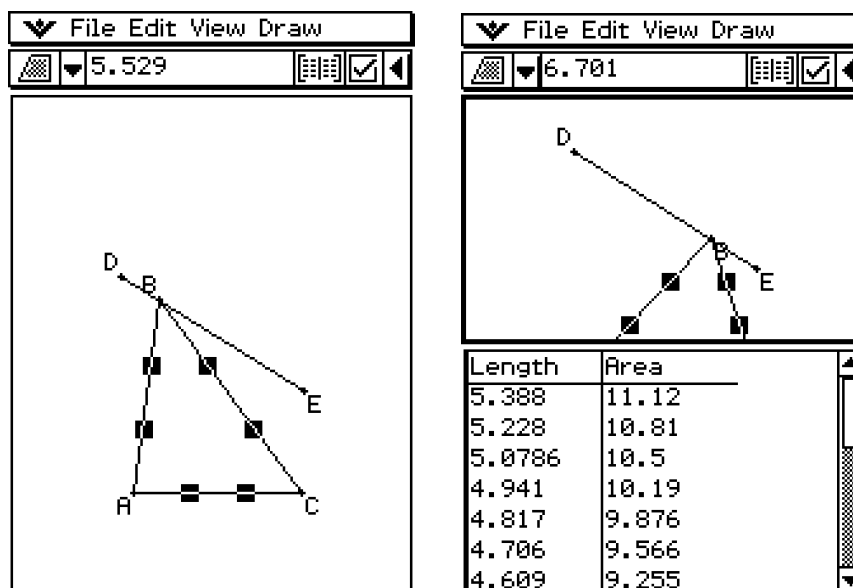

8-6 Using the Geometry Application with Other Applications



You can display the Geometry application from within the eActivity or Main application. This is a great feature that allows you to visualize the relationship between Algebra and Geometry. You can, for example, drag a figure from the Geometry window to the eActivity window to see its corresponding mathematical expression. This section describes how to do this and other useful things.

Drag and Drop

When you open Geometry within another application, you can drag and drop information between the two application windows.

Example 1: To drag a circle from the Geometry window to the eActivity window

• ClassPad Operation

- (1) Tap  to display the application menu, and then tap  to start the eActivity application.
- (2) From the eActivity menu, tap [Insert], [Strip] and then [Geometry].
 - This inserts a Geometry data strip, and displays the Geometry window in the lower half of the screen.

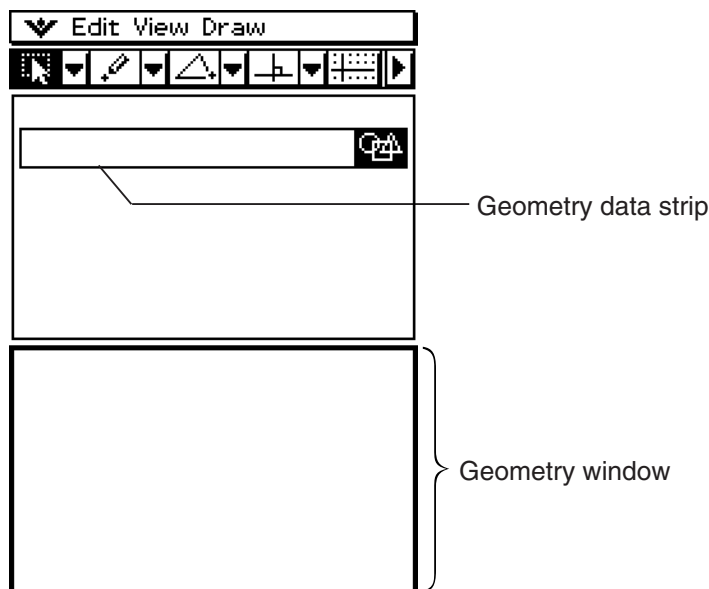

- For details about Geometry data strips, see “Inserting an Application Data Strip” on page 10-3-5.

- (3) Draw a circle on the Geometry window.

- (4) Select the circle and drag it to the first available line in the eActivity window.
- This inserts the equation of the circle in the eActivity window.

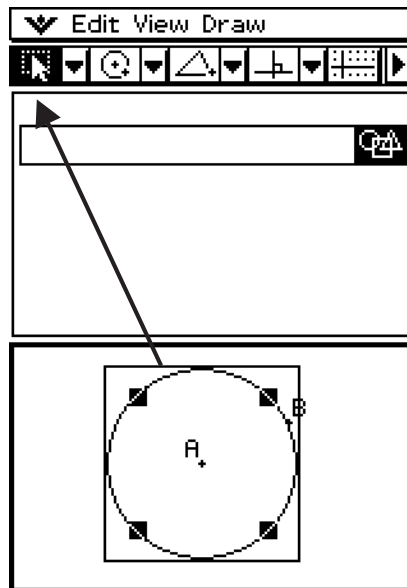

- (5) You can now experiment with the data in the eActivity window.

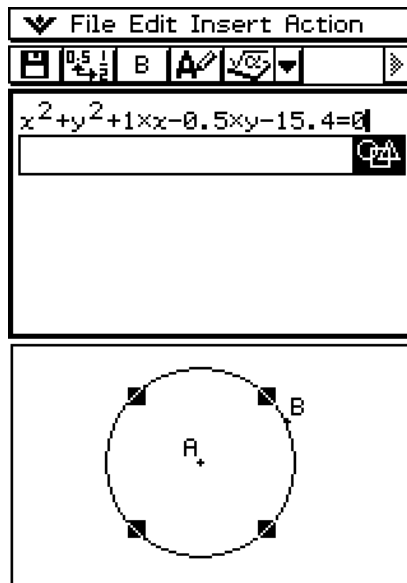



Tip

- Try modifying the radius of the circle in the eActivity window. Highlight your modified equation, then drag it into the Geometry window.

Example 2: To drag two sides of a triangle from the Geometry window to the Main window

• **ClassPad Operation**

- (1) Tap  to display the application menu, and then tap  to start the Main application.
- (2) Tap  to display the Geometry window in the lower half of the screen.

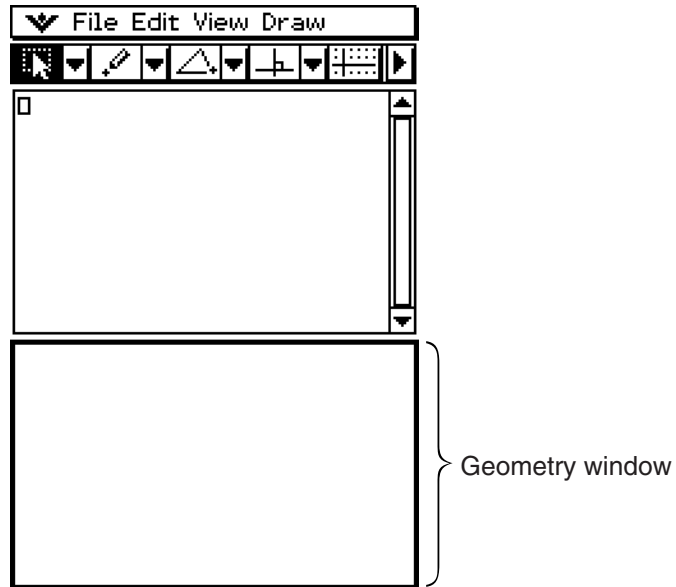

- (3) Draw a triangle on the Geometry window.
- (4) Select two sides of the triangle and drag them to the Main window.
 - This inserts the equations of the sides in the Main window.

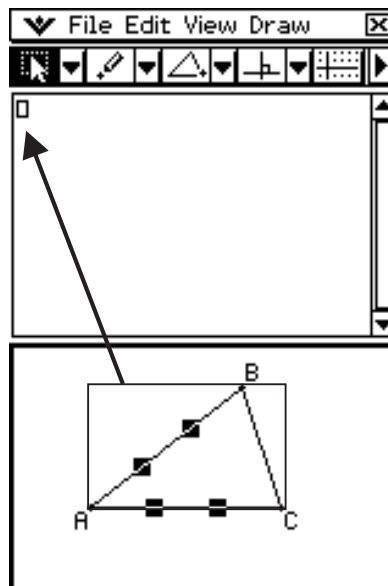

(5) Press EXE .

- Notice that the solution is the same as the coordinates of point A.

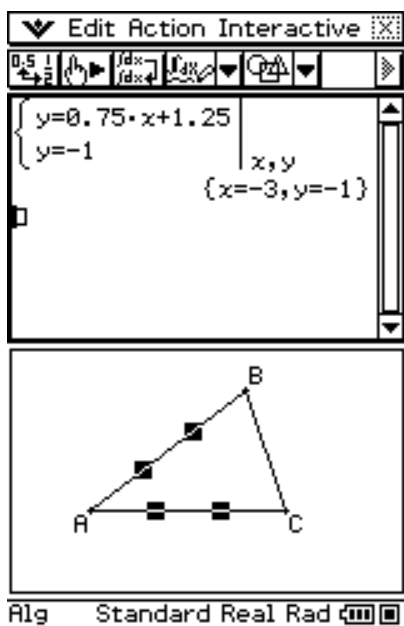

- To show the coordinates of A, just select point A. Its coordinates will be displayed in the status bar.

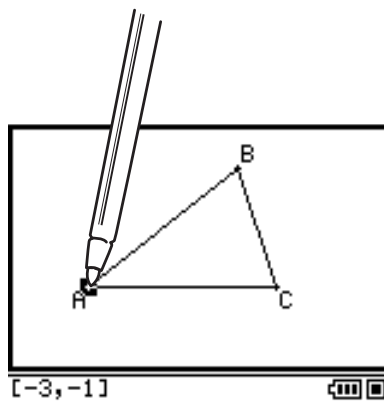

Tip

- Try using this drag and drop method to find the point of intersection of two lines. This is a great way to find the solution to a system of equations.
- To view a fractional result as a decimal, tap the input row and then $\frac{\square}{\square}$.
- The information that appears when you drop a figure into another application depends on the figure you are dragging. Many of the possible outcomes are listed in the table below.

Geometric Figure	Drag and drop into another application transforms to:	Support for drag and drop into a Geometry Link row* in an eActivity
Point	An Ordered Pair	yes
Line Segment	Linear Equation	yes
Infinite Line	Linear Equation	yes
Ray	Linear Equation	yes
Vector	An Ordered Pair (head of vector, assuming the tail is at the origin)	no
Circle	Equation of a Circle	yes
Arc	Equation of a Circle	yes
Ellipse	Equation of an Ellipse	yes
Function ($y=f(x)$)	Equation of the Function	yes
Two Lines	System of Equations	no
Polygon	Matrix Containing each Vertex Point	no
Open Polygon created by Animation	Matrix Containing each Vertex Point	no
Pairs of points related by a transformation	Expression Showing Point Relationship	no

* For details about a Geometry Link row, see "Dynamically Linked Data" on page 8-6-5 and "Inserting a Geometry Link Row" on page 10-3-17.

- When the Geometry application cannot determine what is dropped into it, the dropped data is displayed as text.

Copy and Paste

In addition to drag and drop, you can also copy figures or columns from an animation table, and paste them into another application.

Dynamically Linked Data

Another nice feature of the ClassPad is the ability to create a dynamic link between a geometric figure and its equation in the eActivity window. When a geometric figure is dynamically linked to an equation, you will notice a link symbol (\mathcal{L}) in front of the equation in the eActivity window. Changing the graph in the Geometry window will automatically update the linked data in the eActivity window. Also, changing the data in the eActivity window will update the graph in the Geometry window. Note that this feature is available only within the eActivity application.

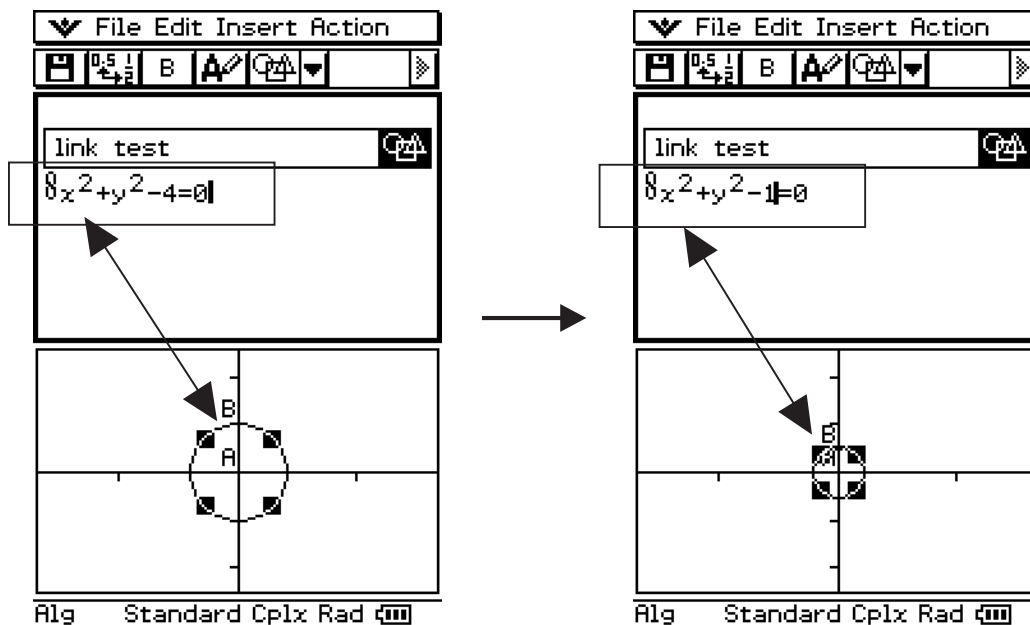

Example of dynamically linked data

For information on how to create a dynamic link between a geometric figure and its equation in the eActivity window, see “Inserting a Geometry Link Row” on page 10-3-17.

8-7 Managing Geometry Application Files

This section covers file management operations such as save, open, delete, rename, move, etc.

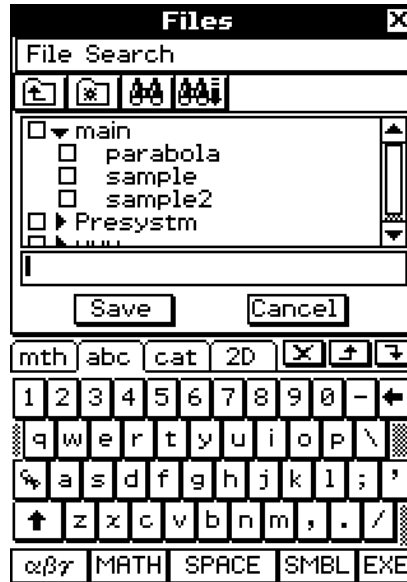

Tip

- You can also use the Variable Manager (page 1-8-1) to manage Geometry application files.

File Operations

• To save a file

- Tap [File] and then [Save].
 - This displays the Files dialog box.

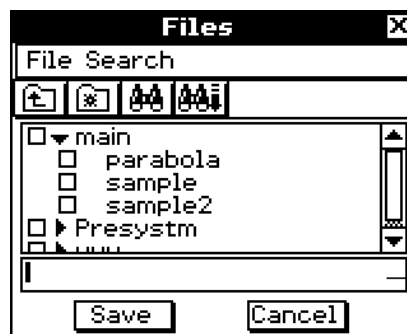

File name edit box

- Tap the name of the folder where you want to save the file so it is selected.
- In the file name edit box, input up to 8 bytes for the file name.
- Tap [Save].

- **To open an existing file**

- (1) Tap [File] and then [Open].
 - This displays the Files dialog box.
- (2) Open the folder that contains the file you want to open.
- (3) Tap the name of the file you want to open so it is selected, and then tap [Open].

- **To search for a file**

- (1) Tap [File] and then [Open].
 - This displays the Files dialog box.
- (2) Tap [Search].
 - This displays the Search dialog box.

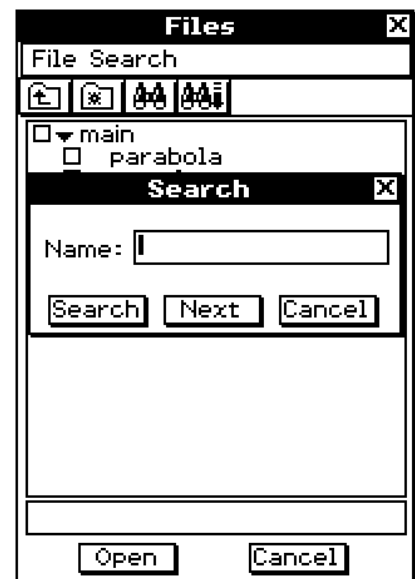

- (3) Enter the file name you want to find and then tap [Search].
 - File names that match the one you enter become highlighted on the display. Tapping [Open] opens the highlighted file.
 - To search for the next occurrence of the file name, tap [Search] again and then tap [Next] on the Search dialog box.

- **To save a file under a different name**

(1) Tap [File] and then [Save].

- This displays the Files dialog box.

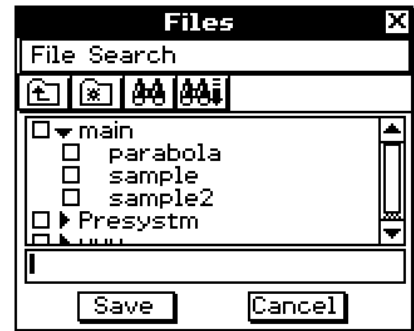

(2) Tap the name of the folder where you want to save the file so it is selected.

(3) Input up to 8 bytes for the new name under which you want to save the file.

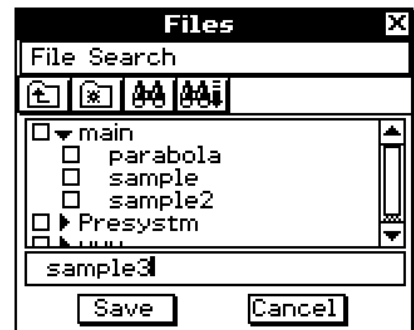

(4) Tap [Save].

- **To delete a file**

(1) Tap [File] and then [Open].

- This displays the Files dialog box.

(2) Select the check box next to the file you want to delete.

- You can select multiple files for deletion, if you want.
- Selecting a check box next to a folder name automatically checks the boxes for all files inside that folder.

(3) Tap [File] and then [Delete].

(4) In response to the confirmation dialog box that appears, tap [OK] to delete the file(s) or [Cancel] to cancel.

(5) To close the Files dialog box, tap [Cancel].

Tip

- Selecting a folder in the above procedure deletes the folder and all of its contents. Note, however, that the “main” folder cannot be deleted, even if you check it.

• To rename a file

- (1) Tap [File] and then [Open].
 - This displays the Files dialog box.
- (2) Tap the name of the file you want to rename so it is selected.
- (3) Tap [File] and then [Rename].
 - This displays the Rename dialog box.
- (4) Enter the new file name.
- (5) In response to the confirmation dialog box that appears, tap [OK] to rename the file or [Cancel] to cancel.
- (6) To close the Files dialog box, tap [Cancel].

• To move a file to another folder

- (1) Tap [File] and then [Open].
 - This displays the Files dialog box.
- (2) Select the check box next to the file you want to move.
 - To move multiple files, select all of their check boxes.
- (3) Tap [File] and then [Move].
 - This causes a dialog box for selecting the destination folder to appear.
- (4) On the dialog box, tap the down arrow button and then select the destination folder from the list that appears.
- (5) Tap [OK].
- (6) To close the Files dialog box, tap [Cancel].



Folder Operations**• To create a new folder**

- (1) Tap [File] and then [Open].
 - This displays the Files dialog box.
- (2) Tap [File] and then [Create Folder], or tap .
- This displays the Create Folder dialog box.
- (3) Enter up to 8 bytes for the folder name.
- (4) In response to the confirmation dialog box that appears, tap [OK] to create the folder or [Cancel] to cancel.
- (5) To close the Files dialog box, tap [Cancel].

- **To delete a folder**

Warning!

Deleting a folder also deletes all files inside of it. Please double-check to make sure you no longer need the contents of a folder before deleting it.

- (1) Tap [File] and then [Open].
 - This displays the Files dialog box.
- (2) Select the check box next to the folder you want to delete.
 - You can select multiple folders for deletion, if you want.
 - Selecting a check box next to a folder name automatically selects the check boxes for all of the files inside that folder.
- (3) Tap [File] and then [Delete].
- (4) In response to the confirmation dialog box that appears, tap [OK] to delete the folder or [Cancel] to cancel.
- (5) To close the Files dialog box, tap [Cancel].

Tip

- You cannot delete the “main” folder.

- **To rename a folder**

Use the procedure under “To rename a file” on page 8-7-4 to rename a folder. Simply select a folder instead of a file.



Chapter 9



Using the Numeric Solver Application

9

This chapter provides information about the functions of the Numeric Solver application, referred to as NumSolve, and explains how to perform Numeric Solver procedures. Numeric Solver lets you obtain the value of any variable in an equation without the need to transform or simplify the equation.

9-1 Numeric Solver Application Overview

9-2 Using Numeric Solver

9-1 Numeric Solver Application Overview

This section describes the configuration of the Numeric Solver application windows and provides basic information about Numeric Solver menu and commands.

Starting Up the Numeric Solver Application

Use the following procedure to start up the Numeric Solver application.

- **ClassPad Operation**

- On the application menu, tap .

Numeric Solver Application Window

Starting up Numeric Solver application displays the window shown below.

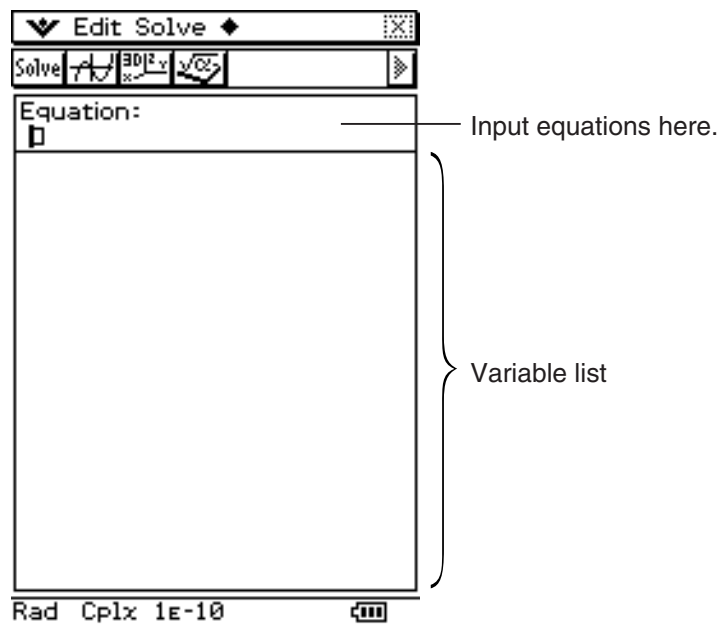

Numeric Solver Menus and Buttons

This section explains the operations you can perform using the menus and buttons of the Numeric Solver window.

- For information about Format related items on  Menu, see “Application Format Settings” on page 1-9-4.

■ Menu

To do this:	Select this  menu item:
Make the Num Solver window active	NumSolve
Make the Graph Editor window active	Graph Editor
Make the 3D Graph Editor window active	3D Graph Editor
Make the Main application active	Main

■ 🗨️ Menu

To do this:	Select this 🗨️ menu item:
Clear all 1-character input variables (a through z)	Clear a-z
Initialize the upper boundary and lower boundary	Initialize Bound
Change the convergence range	Convergence

Important!

- Performing “Clear a-z” operation clears all 1-character variables, regardless of variable data type. Programs and functions with file names from “a” through “z” are also cleared.

■ Toolbar

The toolbar provides you with easy access to the Main application, 3D Graph Editor, Graph Editor, and, of course, Solve.

■ Dragging an Expression from the Other Application to the Numeric Solver Window

You can drag expression and equations from the Main application window or Graph Editor window and drop them into the Numeric Solver window.

• ClassPad Operation

- On the Graph Editor window, input the equation $x^3 + 4 \cdot x^2 + x - 2$.
- Tap the equation to the right of “y1=”. Next, tap [Edit] and then [Select All].
- Drag the equation $x^3 + 4 \cdot x^2 + x - 2$ to the “Equation:” cursor position.

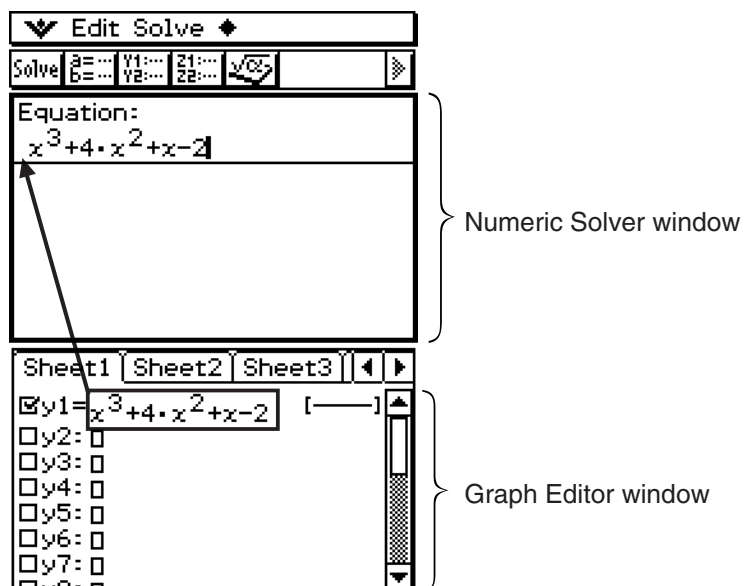

9-2 Using Numeric Solver

Numeric Solver lets you obtain the value of any variable in an equation, without the need to transform or simplify the equation.

Example: t is the time it would take for an object thrown straight up with initial velocity v to reach height h .

Use the formula below to calculate the initial velocity v for a height of $h = 14$ meters and a time of $t = 2$ seconds. Gravitational acceleration is $g = 9.8 \text{ m/s}^2$.

$$h = vt - \frac{1}{2}gt^2$$

• ClassPad Operation

(1) Tap  to display the application menu, and then tap .

- This starts up the Numeric Solver application.

(2)   

(3) Input the equation as it is written, and then tap .

- If you do not input an equal sign (=), the ClassPad assumes that the entire expression is on the left side of the equal sign and that the right side is zero. Inputting more than one equal sign causes an error.

(4) On the list of expression variables that appears, enter values for the variables you want.

You can also specify upper and lower limit values for the solution.

- An error occurs if there is no solution within the range of values you specify.

(5) Select the variable for which you want to solve (so the button next to the variable becomes .

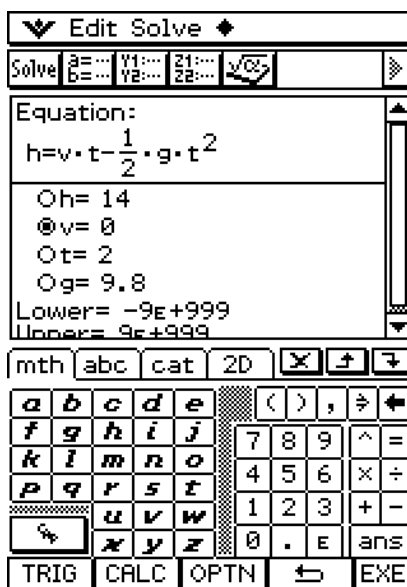

(6) Tap , or tap [Solve] and then [Execute] on the Numeric Solver menu.

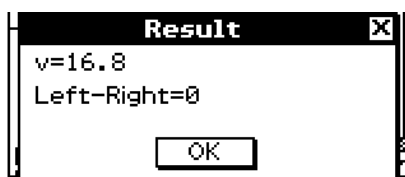

- The [Left–Right] value shows the difference between the left side and right side results.

Tip

- Numeric Solver solves functions by calculating approximations based on Newton’s method. This means that solutions may include errors that are not actual solutions. The accuracy of solutions can be determined by viewing the [Left–Right] value. The closer the [Left–Right] value is to zero, the more accurate the results.
- If ClassPad judges that the displayed results are not converging sufficiently, it displays the message “Did not converge. Do you wish to continue a calculation?” Tap [Yes] to continue, or [No] to cancel the calculation.

Example: Solve the equation $86 = 56.01205897 \log(61 - x)$

- In this example, the initial convergence value is $1E-13$. This is the default setting of the ClassPad unit.

• ClassPad Operation

(1) Tap  to display the application menu, and then tap .

(2)  

(3) Input the equation as written, then tap .

- The variable x is automatically selected because it is the only variable in the equation.

(4) Tap , or tap [Solve] and then [Execute] on the Numeric Solver menu.

- This completes the procedure. If the software is unable to converge to a solution, steps (5) through (8) apply.

(5) The error message appears.



Tap [OK].

9-2-3
Using Numeric Solver

(6) Tap  then [Convergence].

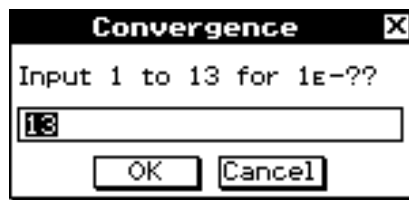

(7) Enter 10 and then tap [OK].

(8) Tap , or tap [Solve] and then [Execute] on the Numeric Solver menu.



- The software is now able to converge to a solution.



Chapter 10

Using the eActivity Application

An eActivity is both a documentation tool, and a student notebook. As a documentation tool, a teacher can create electronic examples and practice problems with accompanying text, mathematical expressions, 2D and 3D graphs, geometric drawings, and tables. eActivities provide the student the means to explore problems, document their learning and problem solving by entering notes, and share their learning by saving their work to a file.

10

10-1 eActivity Application Overview

10-2 Creating an eActivity

10-3 Inserting Data into an eActivity

10-4 Working with eActivity Files

10-5 Transferring eActivity Files

eActivity Data Download Center

A variety of eActivity files are available for download at the CASIO Website. Visit the URL below for more information.

<http://edu.casio.com/products/classpad/>

- After you download an eActivity file, you will need to use FA-CP1 software to transfer it from your computer to your ClassPad. See the instructions provided at the CASIO Website for more information.

10-1 eActivity Application Overview

The eActivity application lets you input and edit text, mathematical expressions, and ClassPad application data, and save your input in a file called an “eActivity”. The techniques you will use are similar to those of a standard word processor, and they are easy to get used to.

Starting Up the eActivity Application

Use the following procedure to start up the eActivity application.

- **ClassPad Operation**

On the application menu, tap .

This starts the eActivity application and displays the eActivity window.

eActivity Application Window

The eActivity application can be used to create a file called an “eActivity”. A basic eActivity can contain text along with application data, which is embedded as a row or a strip. A row can be a “Text Row”, a “Calculation Row”, or a “Geometry Link”. A strip can be an “application data strip” (Main, Geometry, Graph & Table, Conics, Sequence, and so on).

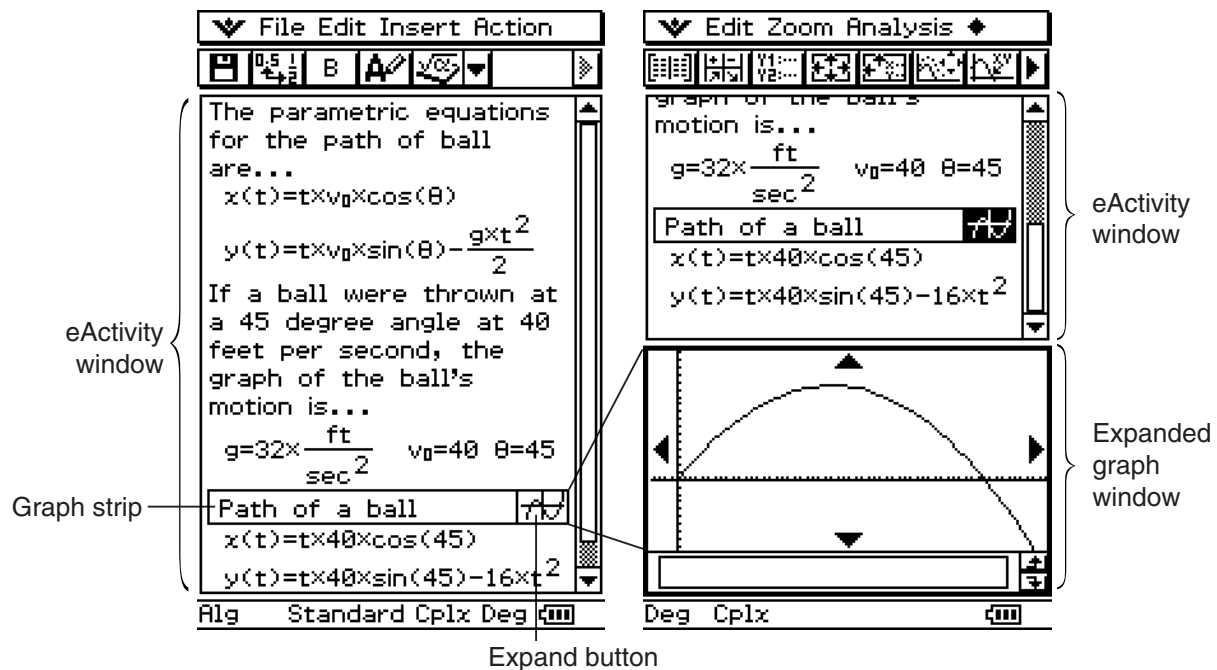

Creating an eActivity is as simple as typing in text and adding application data using the toolbar.



Example eActivity Windows

eActivity Application Menus and Buttons

This section explains the operations you can perform using the menus and toolbar buttons of the eActivity application.

- For information about the  menu, see “Using the  Menu” on page 1-5-4.

■ File Menu





















To do this:	Select this File menu item:
Start a new eActivity	New
Open an existing eActivity	Open
Save the current eActivity to a file	Save
Load the original file again	Reload

■ Edit Menu

To do this:	Select this Edit menu item:
Undo the last operation or redo an operation that was just undone	Undo/Redo
Cut the currently selected string and place it onto the clipboard	Cut
Copy the currently selected string and place it onto the clipboard	Copy
Paste the current clipboard contents onto the screen	Paste
Select all rows and strips on the display	Select All
Delete the contents of the line where the cursor is located	Delete Line
Clear variables that contain numbers, lists and matrices	Clear All Variables
Clear the eActivity window	Clear All



■ Insert Menu







To do this:	Tap this button	Or select this Insert menu item:
Insert a calculation row	—	Calculation Row
Insert a text row	—	Text Row
Insert a Geometry-linked data row	—	Geometry Link
Insert an application data strip		Strip - Graph
		Strip - Graph Editor
		Strip - 3D Graph
		Strip - 3D Graph Editor
		Strip - Conics Graph
		Strip - Conics Editor
		Strip - Geometry
		Strip - Spreadsheet
		Strip - Stat Graph
		Strip - Stat Editor
		Strip - DiffEqGraph
		Strip - DiffEqGraph Editor
		Strip - Financial
		Strip - Probability
		Strip - NumSolve
		Strip - Sequence Editor
		Strip - Picture
		Strip - Notes
		Strip - Main
		Strip - Verify
Add help text to the currently selected strip	—	Add Strip Help

■ Action Menu

To do this:	Do this:
Insert a command (page 2-8-1)	Tap [Action].

Other Buttons

The operations described below are available from the toolbar only. There are no corresponding menu commands for these buttons.

To do this:	Tap this button:
Open the Files dialog box (page 10-2-2)	
Toggles a calculation result between standard (fractional result) and decimal (approximate result)	
Recalculate the equation just for the current line where the cursor is currently located	
Bold the text that is currently selected	
Converts a text row to a calculation row	
Converts a calculation row to a text row	

eActivity Application Status Bar

The information that appears in the eActivity application status bar is same as the Main application status bar information. See “Using Main Application Modes” on page 2-1-4.

eActivity Key Operations

In the eActivity application, the cursor key,  key, and  key operate differently than they do in other modes.



Cursor Key

- The cursor key moves the cursor around the eActivity window.
- Though you can always move the cursor up and down, you may not always be able to move it left and right. The left and right cursor key operations move the cursor left and right in the current row, but for the most part they cannot be used to move the cursor between rows of different types.
- Up and down cursor operations move the cursor between rows, regardless of type.

Key





- Pressing the  key deletes the character to the left of the current cursor position.





Key

- Pressing the  key while the cursor is in a text row inserts a carriage return and adds a new line.
- Pressing the  key while the cursor is in a calculation row re-calculates the expression of the current calculation row as well as all of the calculation rows below the current row.
- Pressing the  key while the cursor is in a Geometry Link row re-calculates the data in the link and updates the corresponding graph in the Geometry window.



Tip

When the shift operation is assigned to the ClassPad  key, you can select a range of characters with the left and right cursor keys. Simply press the ClassPad  key and then press  or . Each press of the cursor key will select (highlight) the next character in the applicable direction.

Example: If the cursor is currently located between the “c” and “1” in “abc123”, press  and then    will select 123.

For information about assigning key operations to the ClassPad’s hard keys, see page 16-16-1





10-2 Creating an eActivity

This provides a general overview of eActivity operations, from starting up the eActivity application to saving an eActivity file. It also presents precautions you need to keep in mind when managing eActivity files.

Basic Steps for Creating an eActivity

The following are the basic steps you need to perform when creating an eActivity. Detailed information about each step is provided in the other sections of this chapter.

• ClassPad Operation

- (1) Tap  to display the application menu, and then tap  to start the eActivity application.
 - This displays the eActivity window as it appeared the last time it was used.
 - If you are already in the eActivity application and there is data on the display, tap [File] and then [New]. Note that [New] clears data from the display without saving it.
- (2) On the eActivity window, insert the text, expressions, application data, and other data you want to include in the eActivity.
 - There are four types of data you can insert into an eActivity: text rows, calculation rows, Geometry Link rows, and application data strips. For details about inserting each type of data, see “10-3 Inserting Data into an eActivity”.

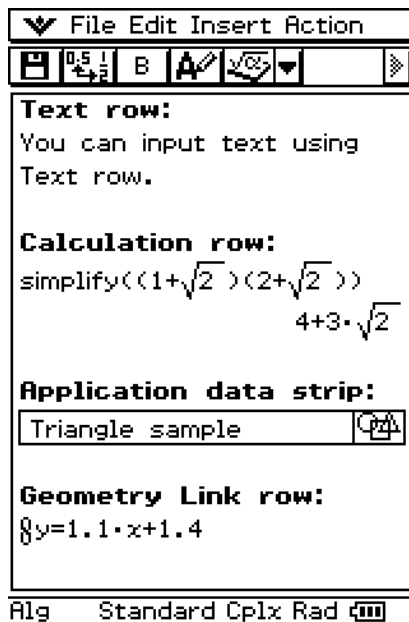

10-2-2
Creating an eActivity

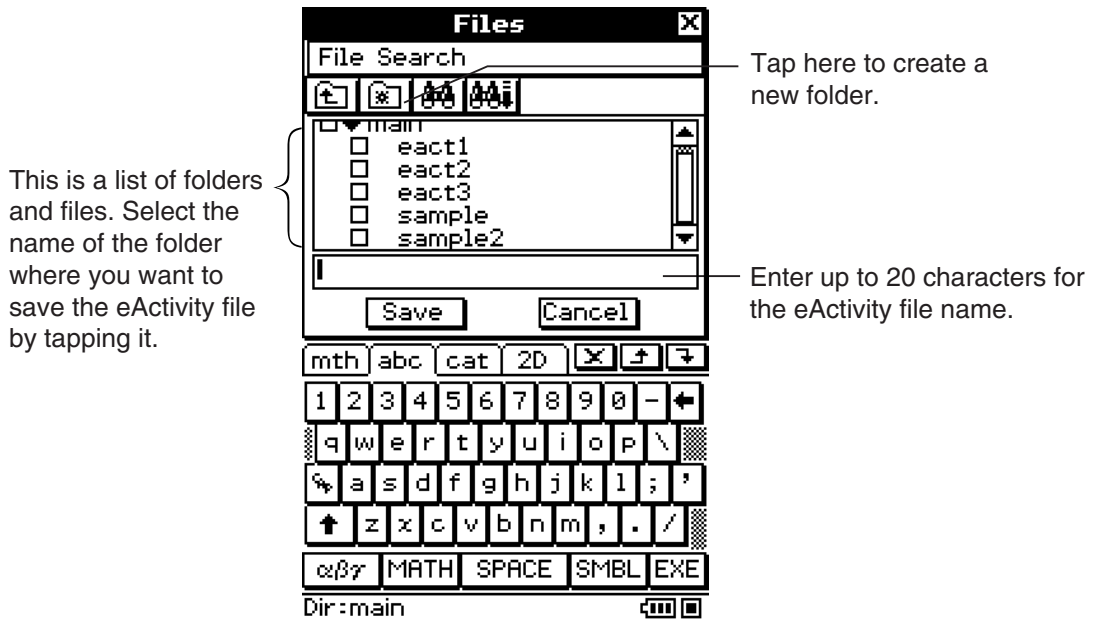

(3) After the eActivity is the way you want, tap [File] and then [Save].

- This displays the Files dialog box.



(4) After selecting a folder and entering a file name, tap [Save] to save the eActivity.

Warning!

- If you do not save the eActivity you are creating before tapping  on the icon panel to display the application menu or before tapping  to display the Main application, the unsaved eActivity data may be deleted.



Managing eActivity Files

This section covers file management operations like save, open, delete, rename, move, etc. Performing one of these operations displays a Files dialog box like the ones shown below. The buttons that appear in the dialog box depend on the operation you performed to display the Files dialog box.

Tap [File] and then [Save].

Tap [File] and then [Open].

Tap .

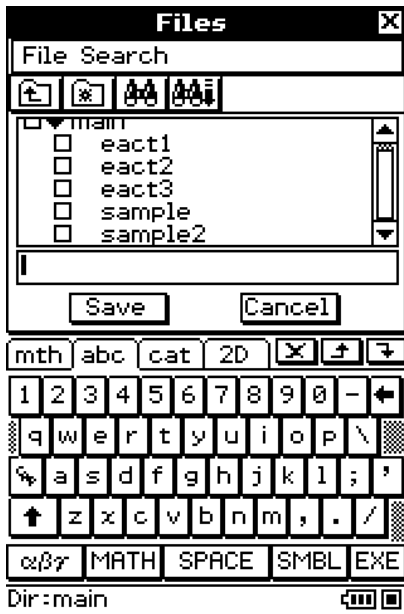

(Includes [Save] button.)

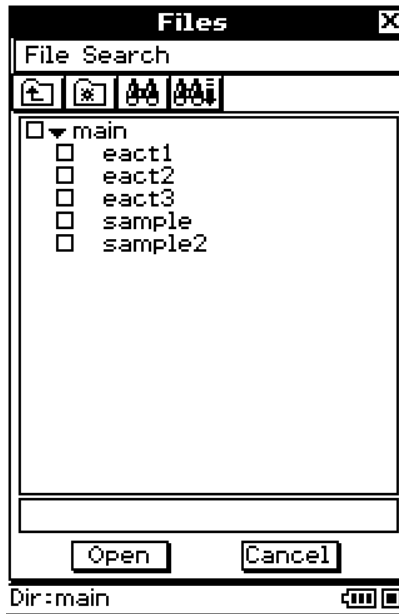

(Includes [Open] button.)

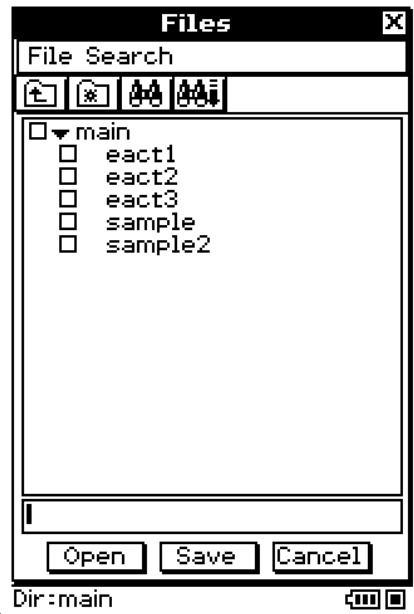

(Includes [Save] and [Open] buttons.)

The operations you can perform on the Files dialog box are identical to those of the Geometry application Files dialog box, except that eActivity file names can contain up to 20 characters (bytes). For details, see “8-7 Managing Geometry Application Files”.

Important!

- eActivity files are stored in a memory area that is separate from that used for storing other types of data (variable data, Geometry data, Presentation data, etc.) Because of this, you cannot access eActivity files data using the Variable Manager. You have to use the eActivity application to perform eActivity file management operations.

10-3 Inserting Data into an eActivity

The following describes the four types of data you can insert into an eActivity.

Text Row

A text row can be used to insert text data and mathematical expression text in natural format. You can also bold the text in a text row.

Calculation Row

Use the calculation row to insert any of the calculation operations that are available in the Main application.

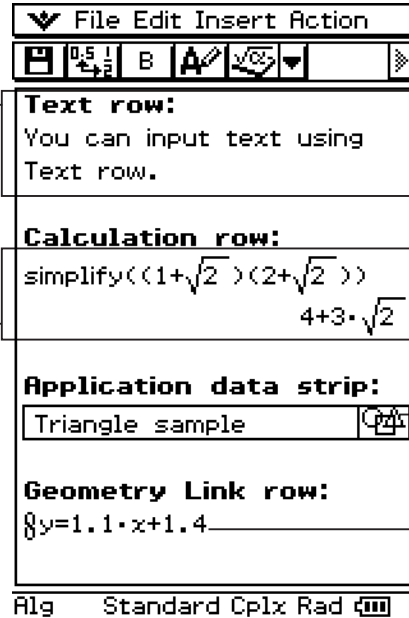

Application data strip

The application data strip lets you display a window from a ClassPad application (Main, Graph & Table, Geometry, etc.) and use the window to create data, which is inserted into the eActivity.

Geometry Link Row

Use this row to insert data that is linked with a Geometry window figure.

Inserting a Text Row

Text rows make it possible to display and edit text directly in the eActivity window. Text rows can contain multiple lines, as well as mathematical expressions. A mathematical expression contained in a text row is not evaluated. Pressing EXE , while in the Text Input mode, will advance you to the next line without displaying results.

Tip

- You can also use the 2D soft keyboard to input mathematical expressions into a text row.



• To select the input mode

- On the eActivity window toolbar, tap the fifth button from the left (A / A) to toggle the input mode between Text Input and Calculation Input.



A button indicates the Text Input mode is selected.

Tip

- The toolbar button for switching between input modes appears as  while the cursor is located in a text row, and  while the cursor is located in a calculation row.

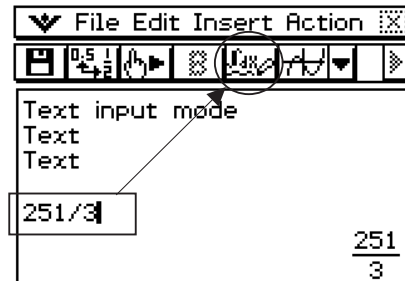
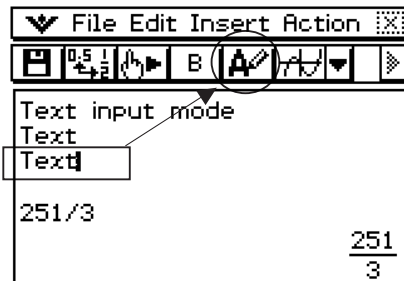

- To insert a Text Row**

(1) Tap  to change a row to the Text Input mode.

- If the cursor is located in a line that already contains input data, place the cursor at the end of the line, tap [Insert] and then [Text Row]. This inserts a text row on the next line.

(2) Use the soft keyboard or keypad keys to input the text you want.

- You can use the alphabet (abc) keyboard to input alphabetic characters.
- Use the other keyboards to input mathematical expressions, commands, etc. Note that any mathematical expressions or commands you input into a text row are treated as text. They are not executed.
- When the text that is input into a text row is too long to fit within the width of the screen, it will wrap automatically to the next line. However, if you are using the 2D soft keyboard to input an expression into a text row using natural display, your input will not wrap to the next line if it does not fit. Instead, the expression will run off the side of the display. Arrows (\blacktriangleleft \blacktriangleright) will appear on the display to indicate when there is something running off the left or right side of the display.

This is the example for word wrap function. When the text line is long, it automatically wrapped to next line.

2D math expression doesn't wrap to next line even if the expression is long.



$$\lim_{a \rightarrow 1} \int_a^b x^2 e^{ax} \left(\sin(x) + \frac{1}{x} + \cos(x) \right) dx$$

This is the example for word wrap function. When the text line is long, it automatically wrapped to next line.

2D math expression doesn't wrap to next line even if the expression is long.

$$\lim_{a \rightarrow 1} \int_a^b x^2 e^{ax} \left(\sin(x) + \frac{1}{x} + \cos(x) \right) dx$$

- **To bold text**

- (1) Drag the stylus across the range of text you want to bold so it is selected (highlighted).
- (2) Tap .
- (3) To unbold text, select it and then tap  again.

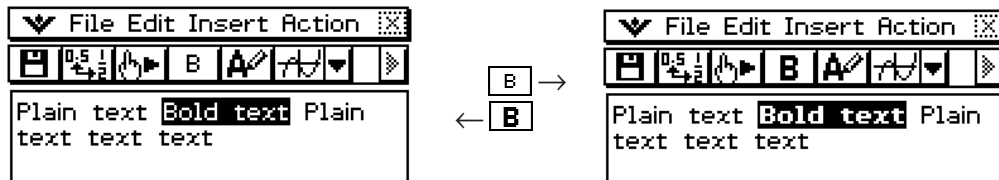

Important!

- You cannot bold numeric expressions of a natural display expression that you input with the 2D soft keyboard.



Inserting a Calculation Row

Calculation rows let you perform calculations in an eActivity. When you input a mathematical expression, the output expression (result) appears, right justified, in the next line. An eActivity that contains only calculation rows looks very much like the Main application window. Note that you can edit the input expression, but not the output expression (result). You can also copy, paste, drag and drop input and output expressions. Both the input and output rows scroll independently in a horizontal direction.

Tip

- If the input expression of a calculation row is not a valid expression, the row will contain only the input expression, without an output expression.

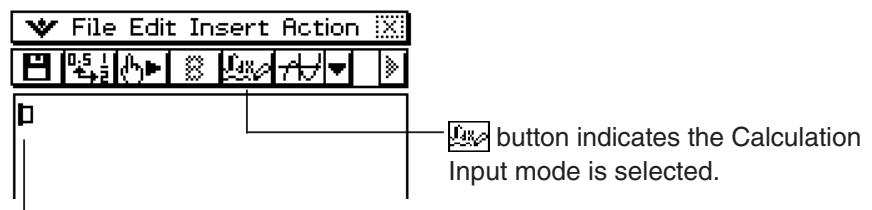

- **To select the input mode**

- (1) On the eActivity window toolbar, tap the fifth button from the left ( / ) to toggle the input mode between Text Input and Calculation Input.



This mark is displayed at the head of the line while the Calculation Input mode is selected.

Tip

- The toolbar button for switching between input modes appears as  while the cursor is located in a text row, and  while the cursor is located in a calculation row.

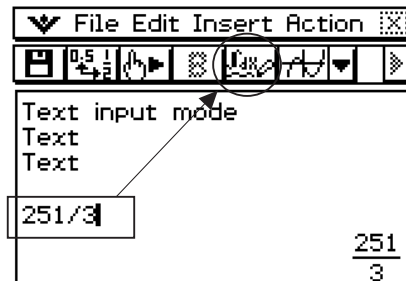
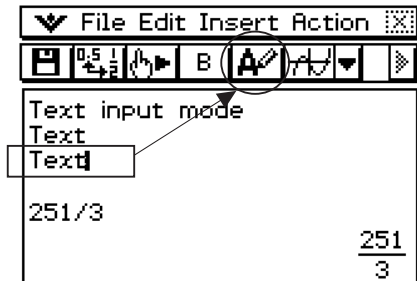

- To insert a Calculation Row**

- Tap  to change a row from the Text Input mode to the Calculation Input mode.
 - If the cursor is located in a line that already contains input data, place the cursor at the end of the line, tap [Insert] and then [Calculation Row]. This inserts a calculation row on the next line.
- Use the soft keyboard or keypad keys to input the mathematical expression you want.
 - Mathematical expression input techniques are identical to those in the Main application. See Chapter 2 for more information.
- Press EXE after inputting an expression to display its result.

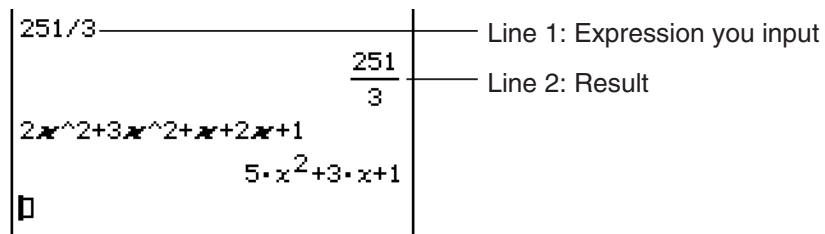

- If you want to input an expression without displaying its result, do not press EXE . Instead, tap [Insert] and then [Text Row] to input a text row. Or you could change the current row from a calculation row to a text row by tapping  while the cursor is in the row.

Important!

- If you edit the expression in an existing calculation row and then press EXE , all of the expressions following the line you edited are re-calculated and their results are refreshed. Even mathematical expressions you originally input into the eActivity without calculating their results are calculated, and their results appear.

Changing “10 \Rightarrow b ” to “20 \Rightarrow b ” in the example below and pressing EXE causes all of the expressions under “20 \Rightarrow b ” to be re-calculated.

File Edit Insert Action		File Edit Insert Action	
$5 \Rightarrow a$	5	$5 \Rightarrow a$	5
$10 \Rightarrow b$	10	$20 \Rightarrow b$	20
$a+b$	15	$a+b$	25
$a-b$	-5	$a-b$	-15
a/b	$\frac{1}{2}$	a/b	$\frac{1}{4}$
\square		\square	

- Tap to the right of “10”.
- Press \leftarrow twice, and then input “20”.

- Press EXE .

• To run a program in the eActivity application

You can use an eActivity application calculation row to specify a program name, and execute the program. For more information, see “2-13 Running a Program in the Main Application.”

Inserting an Application Data Strip

An application data strip can be used to embed data from other ClassPad applications into an eActivity. An application data strip contains the elements shown below.

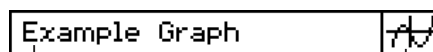





















Title
You can enter a title, if you want.

Expand button
Tap here to display the application data in the lower window.

■ Inserting an Application Data Strip into an eActivity

Tap the [Insert] menu or the right most toolbar down arrow button, and then select the command or button that corresponds to the type of application data you want to insert.

To insert this type of application data:	Select this [Insert] menu item:	Or tap this button:
Graph & Table application Graph window data	Strip - Graph	
Graph & Table application Graph Editor window data	Strip - Graph Editor	
3D Graph application 3D Graph window data	Strip - 3D Graph	
3D Graph application 3D Graph Editor window data	Strip - 3D Graph Editor	
Conics application Conics Graph window data	Strip - Conics Graph	
Conics application Conics Editor window data	Strip - Conics Editor	
Geometry application Geometry window data	Strip - Geometry	
Spreadsheet window data	Strip - Spreadsheet	
Statistics application Statistical Graph window data	Strip - Stat Graph	
Statistics application Stat Editor window data	Strip - Stat Editor	
Differential Equation application Differential Equation Graph window data	Strip - DiffEqGraph	
Differential Equation application Differential Equation Graph Editor window data	Strip - DiffEqGraph Editor	
Financial application window data	Strip - Financial	
Probability window* ¹ data	Strip - Probability	
NumSolve application Numeric Solver window data	Strip - NumSolve	
Sequence application Sequence Editor window data	Strip - Sequence Editor	
Picture Viewer window* ²	Strip - Picture	
Notes window* ²	Strip - Notes	
Main application work area window data	Strip - Main	
Verify window* ¹ data	Strip - Verify	

*¹ The Probability window and Verify window can be used with the eActivity application and Main application. For more information see “2-11 Using Verify” and “2-12 Using Probability”.

*² The Picture Viewer window and Notes window can be used with the eActivity application only.

Example 1: To insert a Geometry data strip

• **ClassPad Operation**

(1) From the eActivity menu, tap [Insert], [Strip], and then [Geometry].

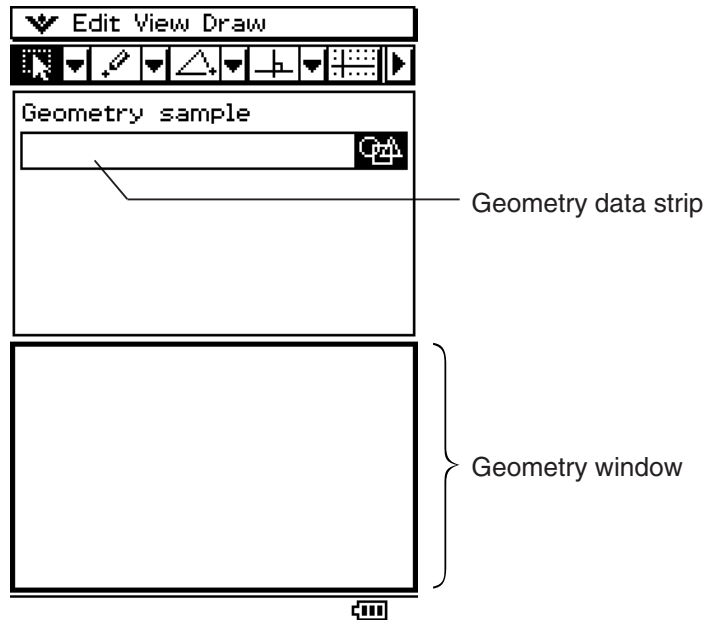

- This inserts a Geometry data strip, and displays the Geometry window in the lower half of the screen.

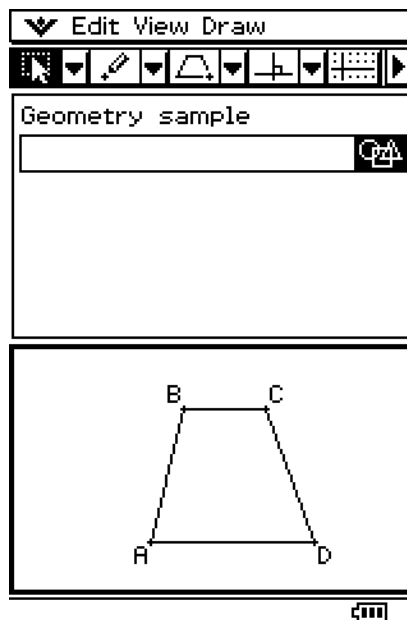

(2) On the Geometry window, draw the figure you want.

- For details about Geometry window operations, see Chapter 8.



(3) After you finish performing the operation you want on the Geometry window, tap , or tap  and then [Close] to close the Geometry window and return to the eActivity window.

(4) Tap the title box of the Geometry data strip and enter the title you want.



- If you want to input more data into the eActivity, tap the next line or use the [Insert] menu to select the type of strip you want to insert next.

Example 2: To insert a Graph data strip

• **ClassPad Operation**

(1) On the eActivity window, tap [Insert], [Strip], and then [Graph].

- This inserts a Graph data strip, and displays the Graph window in the lower half of the screen.

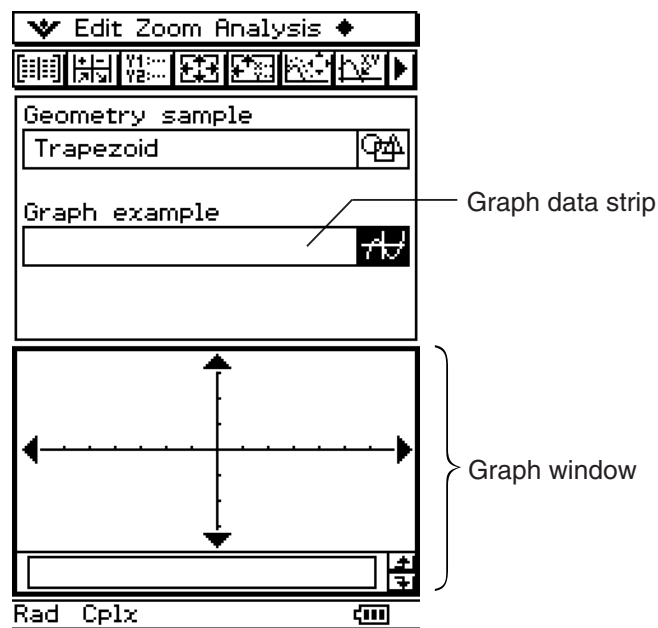

(2) On the Graph window, draw the graph you want.

- Tap the  button to display the Graph & Table application's Graph Editor window, enter a function to graph, and then graph the function. For details about inputting functions on the Graph Editor window and graphing functions, see Chapter 3.

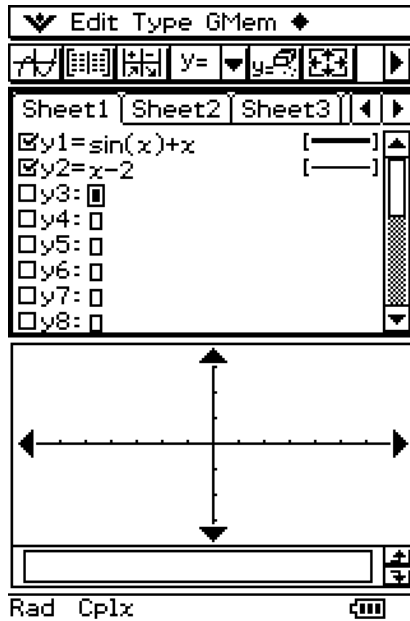

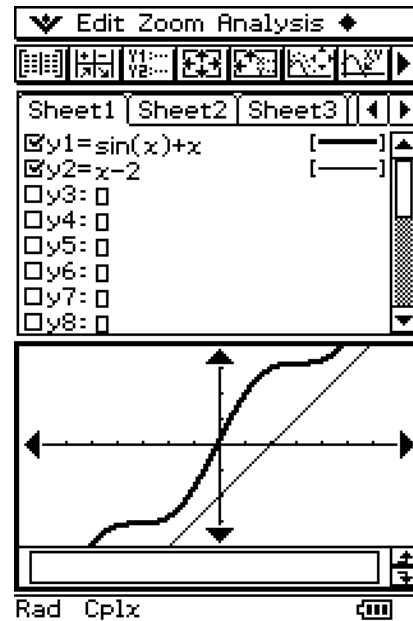

Display the Graph Editor window and input the function.

Tap .



Graph the function.

(3) After you finish performing the operation you want on the Graph window, tap , or tap  and then [Close] to close the Graph window. You will also need to tap the Graph Editor window, and then select  then [Close] to return to the eActivity window.

(4) Tap the title box of the Graph data strip and enter the title you want.

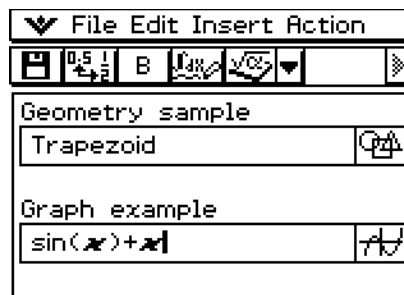

- If you want to input more data into the eActivity, tap the next line or use the [Insert] menu to select the type of row or strip you want to insert next.

Example 3: To use Notes in an eActivity

Notes is a simple text editing tool for taking notes or including in-depth explanations within an eActivity. You can use Notes to store information for later use, or as a place to jot down ideas.

- **ClassPad Operation**

(1) On the eActivity window, tap [Insert], [Strip], and then [Notes].

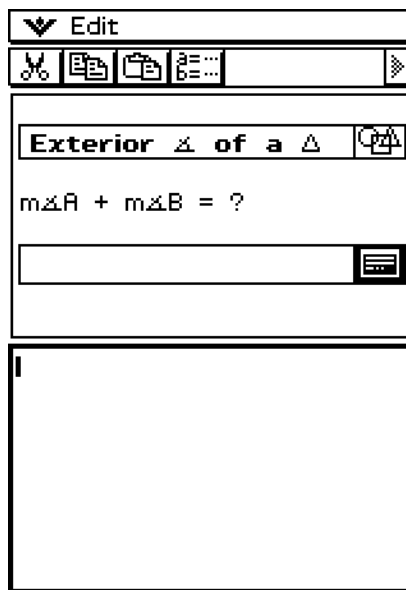

- This inserts a Notes strip and displays the Notes window in the lower half of the screen.



(2) Enter text you want in the Notes window.

- You can use the Edit menu and toolbar to perform following operations while the Notes window is on the display.

To do this:	Select this Edit menu item:	Or tap this button:
Undo the last operation or redo an operation that was just undone	Undo/Redo	—
Bold a range of selected text	—	
Unbold a range of selected text	—	
Cut the currently selected string and place it onto the clipboard	Cut	
Copy the currently selected string and place it onto the clipboard	Copy	
Paste the current clipboard contents onto the screen	Paste	
Select all text on the Notes window	Select All	—
Clear all text from the Notes window	Clear All	—
Display the Variable Manager (page 1-8-1)	—	

- (3) After you finish entering text, you can close the Notes window by tapping , or tapping  and then [Close].

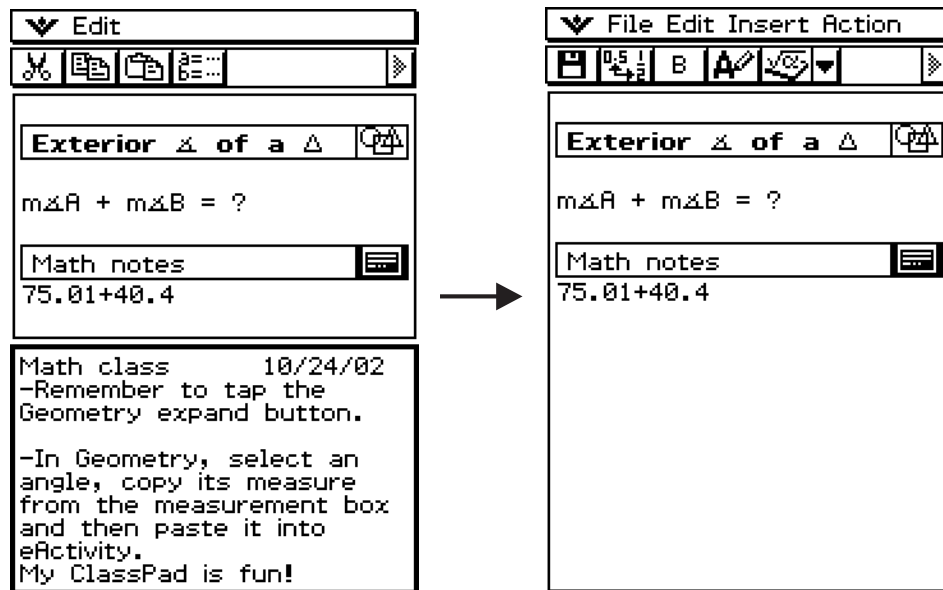

Tip

- You can use the Notes window to enter notes, homework assignments, in-depth details, etc.
- All information you enter is treated as text.
- When inputting text into a Notes window, the cursor will jump down to the beginning of the next line when the right edge of the current line is reached.
- The Notes application is available only in eActivity.

Example 4: To use the Picture Viewer with eActivity

You can use Picture to display a bitmap image (PICT data type) in an eActivity. You can also save displayed images with a different name.

Tip

- For details about data whose data type is PICT, see “Variable Data Types” on page 1-7-3.

• ClassPad Operation

(1) On the eActivity window, tap [Insert], [Strip], and then [Picture].

- This will insert a Picture strip and display the Picture window in the lower half of the display.

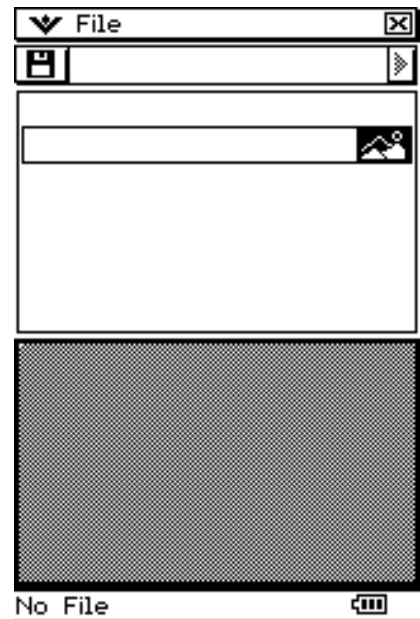

(2) Tap [File] - [Open].

- This displays the Files dialog box. The Files dialog box displays only data whose data type is PICT.

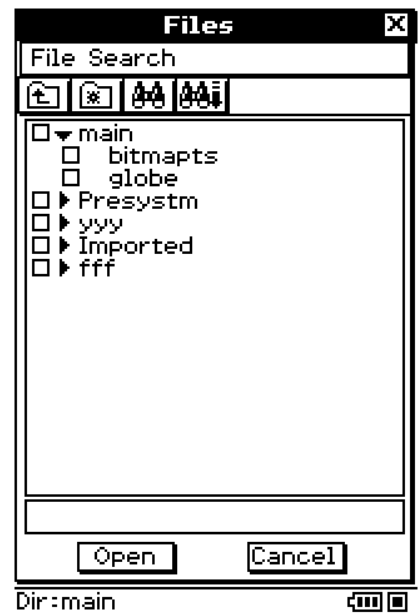

(3) On the Picture window, tap the name of the PICT data you want to view.

(4) Tap [Open].

- This will display the PICT data you selected in the Picture window.

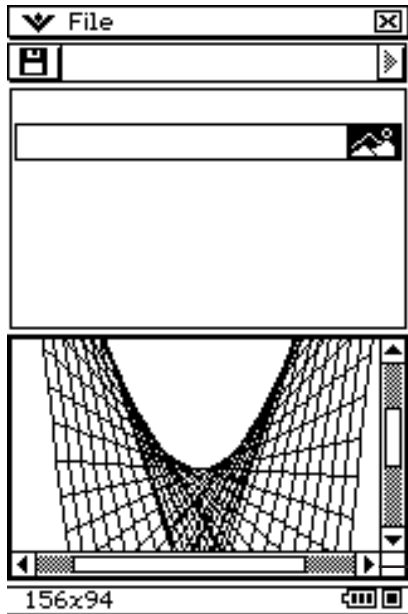

A scroll bar will appear along the bottom of the window if the PICT data does not fit.

- You can use the File menu and toolbar to perform following operations while the Picture window is on the display.



To do this:	Select this File menu item:	Or tap this button:
Open a bitmap (PICT data type) image	Open	—
Save an open bitmap image	Save	

(5) After performing all the operations you want, tap the button in upper right corner to close the Picture window.

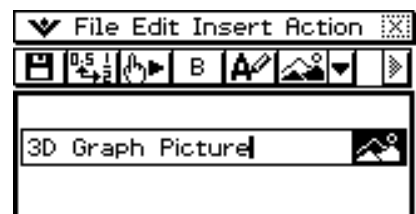
(6) Tap the title box of the Picture strip and enter the title you want.



Strip Help Text

You can add help text to any strip. A strip that has help text is indicated by a  button. Tapping a  button will display the help window along with the application window.

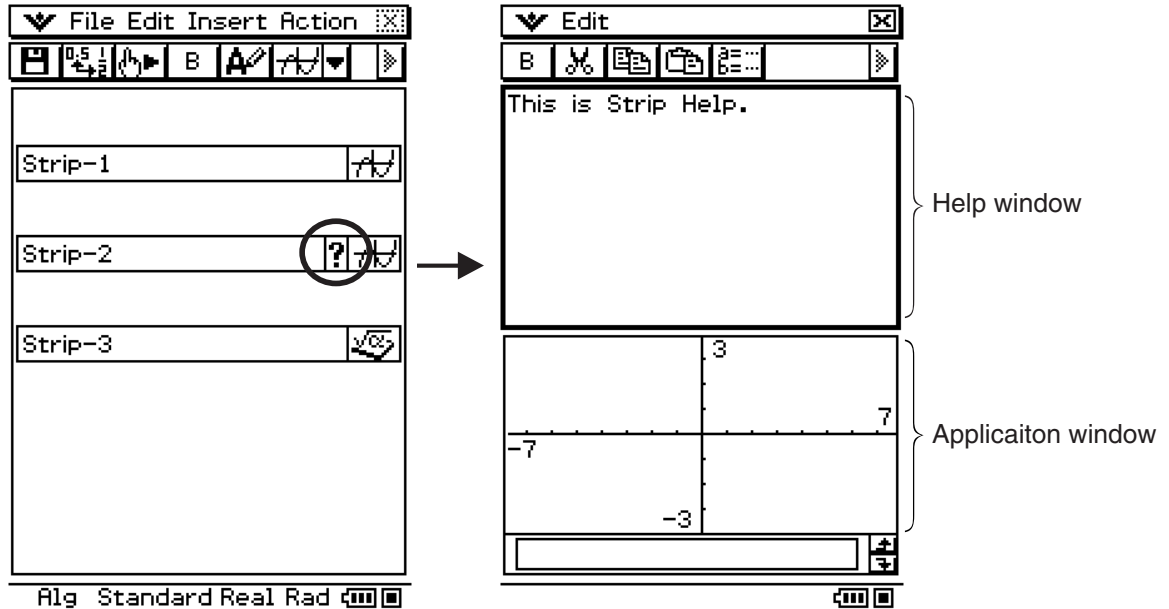

• To add help text to a strip

- (1) Tap the title box of the strip to which you want to add help text.
- (2) Tap [Insert] - [Add Strip Help].

- A help window appears in the upper half of the display, while the application that was called from the strip appears in the lower half of the display.

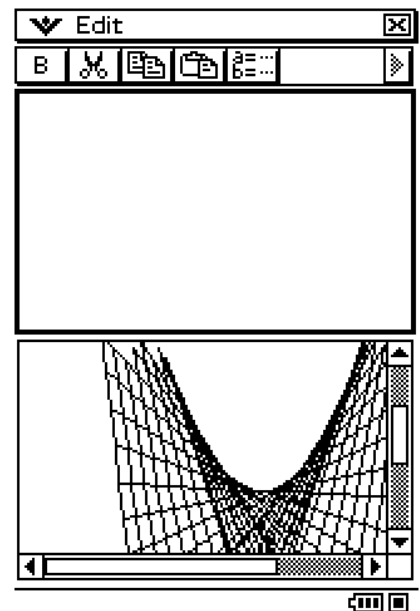

(3) Input the help text into the help window.

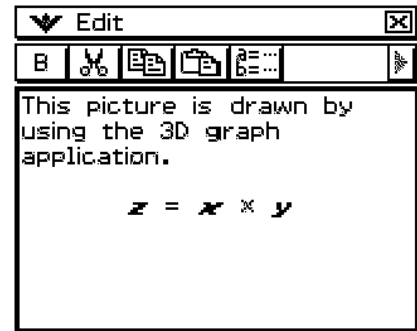

- The operations you can perform while inputting help text are the same as those you use for eActivity notes. For more information, see “Example 3: To use Notes in an eActivity” on page 10-3-10.

(4) After inputting all the text you want, tap the  button in upper right corner to close the help window.

- The strip will now have a  button.

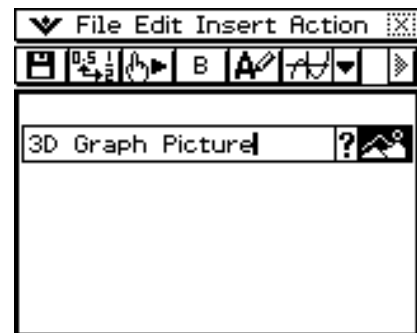

• To delete help text from a strip

(1) Tap the title box of the strip whose help text you want to delete.

(2) Tap [Insert] - [Remove Strip Help].

- This will delete the help text and cause the  button to disappear.

Moving Information Between eActivity and Applications

An eActivity is like an interactive notebook or textbook that allows you to explore the world of mathematics right on the page. You can take almost any expression from an eActivity page and send it to another application. You can also take information from an application and insert it into an eActivity page.

■ Cut, Copy, and Paste

You can cut, copy, or paste text or mathematical expressions between the eActivity and any other application. You can also cut, copy, and paste text and mathematical expressions inside an eActivity.

Depending on the application, you can cut or copy, and paste text and mathematical expression data into an eActivity. For example, you can copy a line in the Geometry measurement box and paste it into an eActivity as an expression.

■ Drag and Drop

You can drag and drop text or mathematical expressions between eActivity and other applications. You can also drag and drop within an eActivity. Depending on the application, you can drag text and mathematical expressions from an eActivity to another application window. For example, you can drag an equation from the eActivity directly onto a graph window.

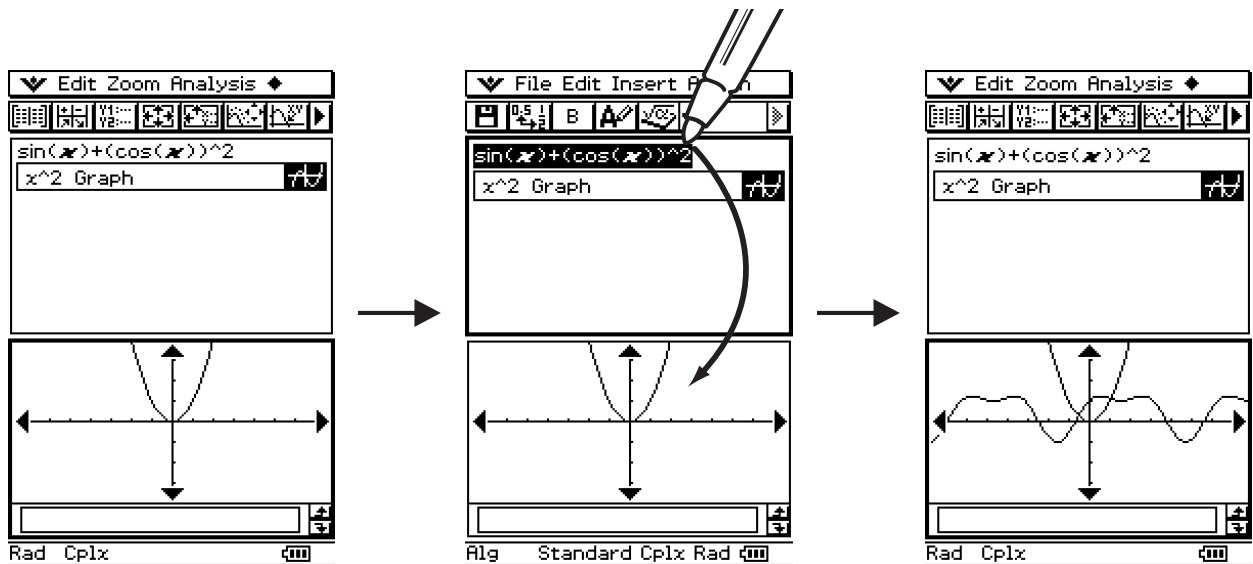

(1) Graph strip is expanded in the lower window.

(2) Expression is selected in the eActivity.

(3) Expression has been dragged into the graph window.

Tip

- For details about what you can drag and drop between the eActivity window and Geometry window, see “8-6 Using the Geometry Application with Other Applications”.

Inserting a Geometry Link Row

A Geometry Link row dynamically links data in the Geometry window with the corresponding data in an eActivity. You can display lines and figures drawn in Geometry as values and mathematical expressions in a Geometry Link row.

Dragging a line or figure from the Geometry window to a Geometry Link row in an eActivity converts the line or figure to its mathematical expression. This expression is interlinked with its Geometry window figure, so modifying one causes a corresponding change in the other.

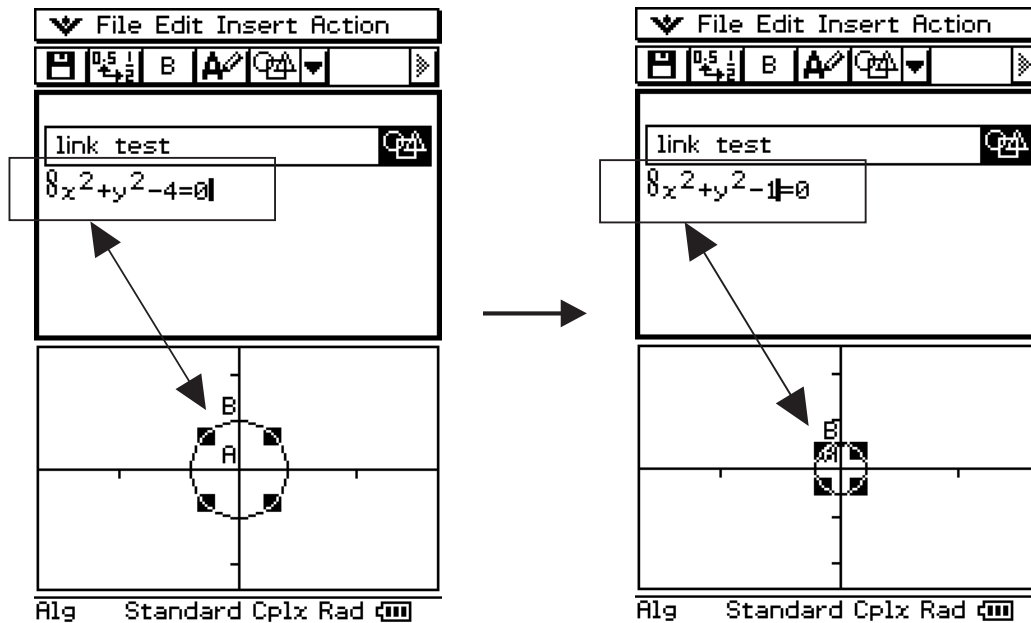

Example of inserting a Geometry Link row

Modifying the equation in a Geometry Link updates the figure in the Geometry window. Conversely, changing the shape, position, or some other parameter of the figure on the Geometry window updates the equation in the Geometry Link.

• To input a Geometry Link row

Example: To drag one side of a triangle drawn on the Geometry window and link it to an eActivity

- (1) Open the eActivity application. Next, tap [Insert], [Strip], and then [Geometry] to insert a Geometry strip.
- (2) On the Geometry window that appears in the lower half of the screen, draw a triangle.
 - For details about Geometry window operations, see Chapter 8.
- (3) Tap the eActivity window just below the Geometry strip.
 - This makes eActivity the active window.

(4) Tap [Insert] and then [Geometry Link].

- This inserts a Geometry Link row in the next line.

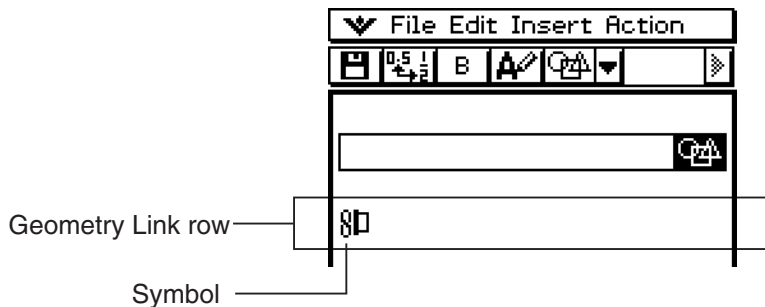

(5) Tap the Geometry window to make it active.

(6) Tap one side of the triangle to select it, and then drag it to the link symbol in the eActivity window.

- This inputs the equation of the line that represents the side of the triangle into the link.
- Modifying the equation in the Geometry Link row and pressing EXE causes a corresponding change in the Geometry window (lower right screenshot).
- The example below shows how the isosceles triangle ABC ($CA = BC$) changes when the equation in the Geometry Link row is changed from $y = 1.91x + 0.983$ to $y = x + 2$.

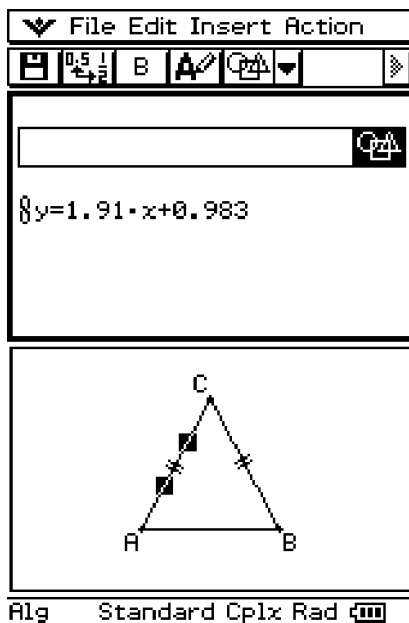

- Drag the stylus across $1.91x + 0.983$.

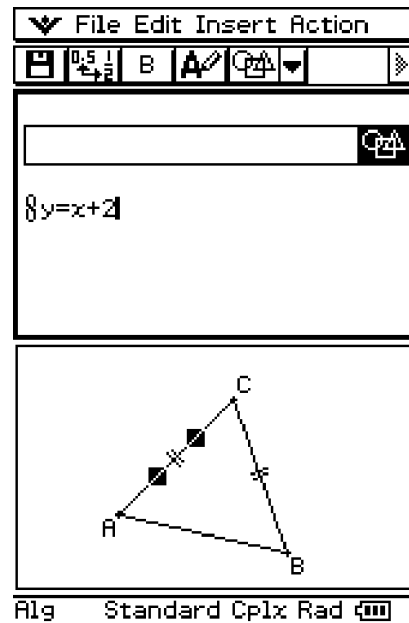

- Input $x + 2$.
- Press EXE .

Tip

- Dragging a line or figure from the Geometry window to a text row or calculation row in an eActivity also converts the figure to its value or equation. In this case, however, data in the text row or calculation row is not interlinked with the Geometry window figure.
- Pressing EXE after changing data in a Geometry Link updates the corresponding figure in the Geometry window.
- Changing the figure in the Geometry window will cause the linked data in an eActivity to update accordingly.

10-4 Working with eActivity Files

You can perform basic file operations on eActivity files. You can open previously saved files, edit an existing file, and save a file under a new name.

Opening an Existing eActivity

Perform the following steps to open an existing eActivity file.

• ClassPad Operation

(1) On the eActivity window, tap [File] and then [Open].

- This displays the Files dialog box.

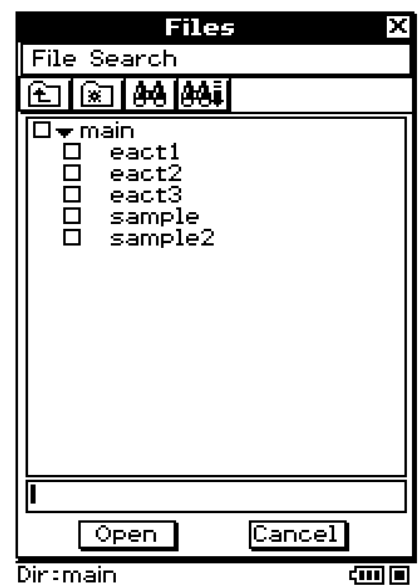

(2) Select the name of the eActivity file you want to open by tapping it.

(3) Tap [Open].

- This opens the eActivity you selected in step (2).

Browsing the Contents of an eActivity

- When you first open an eActivity, its data appears on the window starting from line 1. Use the scroll bar to scroll the window contents if necessary.
- To view the contents of an application data strip in the eActivity, tap the expand button (which is the icon in the data strip). For more information, see “Expanding an Application Data Strip” below.

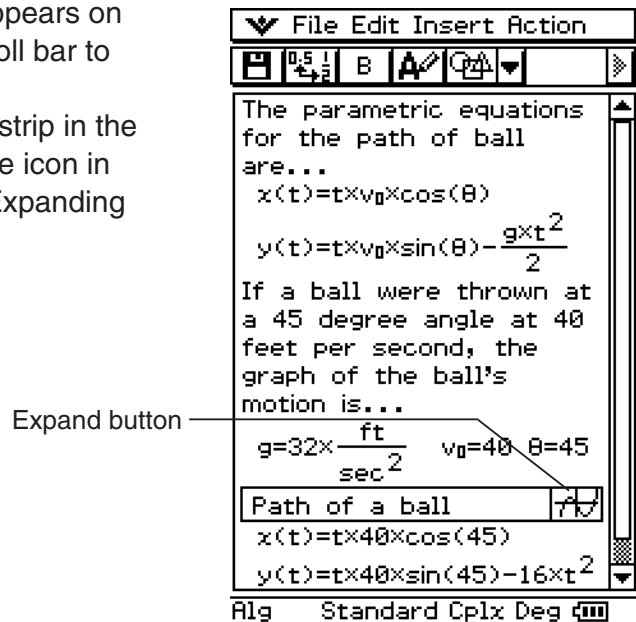

Editing the Contents of an eActivity

To edit an eActivity, you can use the same procedures that you used when you created it. For more information, see “10-3 Inserting Data into an eActivity”.

Expanding an Application Data Strip

Tapping the expand button of an application data strip expands the application data in the lower window. The expand button of a data strip is highlighted to indicate that it is expanded in the lower window.

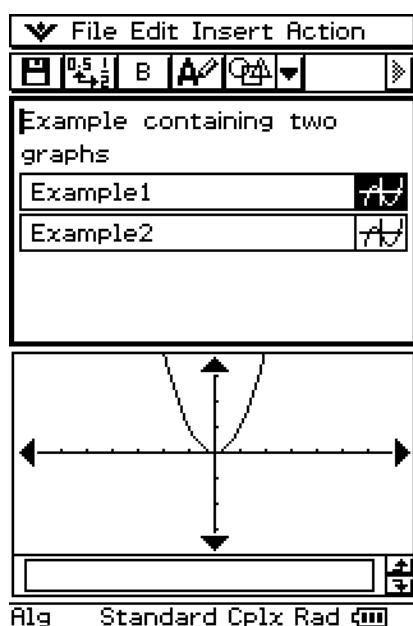

Indicates Example 1 is expanded.

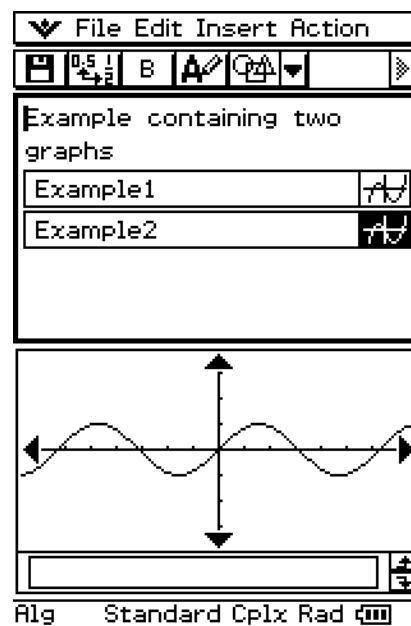

Indicates Example 2 is expanded.

Modifying the Data in an Application Data Strip

Modifying application data on an application window in the lower eActivity window causes the eActivity data to be modified as well. If you change the equation in the eActivity Graph window, for example, the new graph will become the data of the eActivity.

This means that when you save and then reopen an eActivity file, tapping the application data strip's expand button again will cause the new graph to be displayed.

Saving an Edited eActivity

As with any other file, there are two ways to save an edited eActivity: resaving the original eActivity with the newly edited eActivity, or saving the edited data under a different file name as a new eActivity, without changing the originally opened eActivity.

• To replace the original eActivity file with the newly edited version

(1) On the eActivity window, tap [File] and then [Save].

- This displays the Files dialog box.



Current eActivity file name

(2) Tap [Save] without changing the displayed file name.

- This causes the original eActivity file to be replaced by the newly edited version.

• To save an edited eActivity under a different name

- (1) On the eActivity window, tap , or tap [File] and then [Save].
 - This displays the Files dialog box.
- (2) If you want, tap the name of the folder where you want the new eActivity file to be saved.
- (3) Tap the file name input box, and input the new file name you want to use.
- (4) When everything is the way you want, tap [Save].
 - This saves the eActivity as a new file under the file name you specified.



10-5 Transferring eActivity Files

Note the following precautions when using the ClassPad's data communication function to transfer eActivity files with another ClassPad unit or a computer.

Transferring eActivity Files between Two ClassPad Units

■ Transferring eActivity Files to Another ClassPad Unit

To transfer an eActivity file to another ClassPad unit, the receiving unit must support all of the following types of application data strips.*

Application Data Strips

Graph, Graph Editor, 3D Graph, 3D Graph Editor, Conics Graph, Conics Editor, Geometry, Spreadsheet, Stat Graph, Stat Editor, DiffEqGraph, DiffEqGraph Editor, Financial, Probability, NumSolve, Sequence Editor, Picture Viewer, Notes, Main, Verify

*For details about application data strips, see "Inserting an Application Data Strip" on page 10-3-5.

Important!

- If you transfer an eActivity file to a ClassPad unit that does not support all of the application data strips listed above, the receiving ClassPad unit will not be able to open the file.
- Do not transfer eActivity files to a ClassPad unit that does not support all of the application data strips listed above.
- The functions of this ClassPad unit are different from the functions of a ClassPad unit that does not support all of the application data strips listed above. Because of this their eActivity files are incompatible with each other. Do not transfer eActivity files between two ClassPad units that are equipped with different application data strips.



■ Transferring eActivity Files from Another ClassPad Unit

To transfer an eActivity file from another ClassPad unit, your ClassPad unit must support all of the application data strips that are supported by the sending unit.

Important!

- If you transfer an eActivity file from a ClassPad unit that supports application data strips that are not supported by this ClassPad unit, you will not be able to open the file.
- Do not transfer eActivity files from another ClassPad unit if your ClassPad unit does not support all of the application data strips of the sending unit.
- The functions of this ClassPad unit are different from the functions of a ClassPad unit that supports application data strips not supported by this unit. Because of this their eActivity files are incompatible with each other. Do not transfer eActivity files between two ClassPad units that are equipped with different application data strips.

Transferring eActivity Files between a ClassPad Unit and a Computer

You can use FA-CP1 to transfer eActivity files between your ClassPad and computer. Before doing so, however, you should check the version numbers of the FA-CP1 application running on your computer and the operating system running on your ClassPad to make sure they are compatible with each other. For details, see the FA-CP1 User's Guide.



Chapter 11

Using the Presentation Application

The Presentation application lets you capture screenshots of other application windows. Screenshots can be used in the classroom or for other presentations simply by connecting the ClassPad to an OHP projector.



- 11-1 Presentation Application Overview**
- 11-2 Building a Presentation**
- 11-3 Managing Presentation Files**
- 11-4 Playing a Presentation**
- 11-5 Editing Presentation Pages**
- 11-6 Configuring Presentation Preferences**
- 11-7 Presentation File Transfer**

11-1 Presentation Application Overview

The Presentation application lets you capture screenshots produced by the ClassPad, and arrange them into a “presentation” that you can play back. With this application you can build and play a presentation, and edit the contents of a presentation. A presentation, for example, can show how to obtain intermediate and final results of calculation operations.

Specifically, the Presentation application can be used as follows.

- A teacher can use Presentation to create materials that explain mathematical concepts, and distribute them to students.
- A student can use Presentation as a tool to present reports, assignments, and projects.
- Students and teachers can use Presentation to store ClassPad screenshots for later reference.

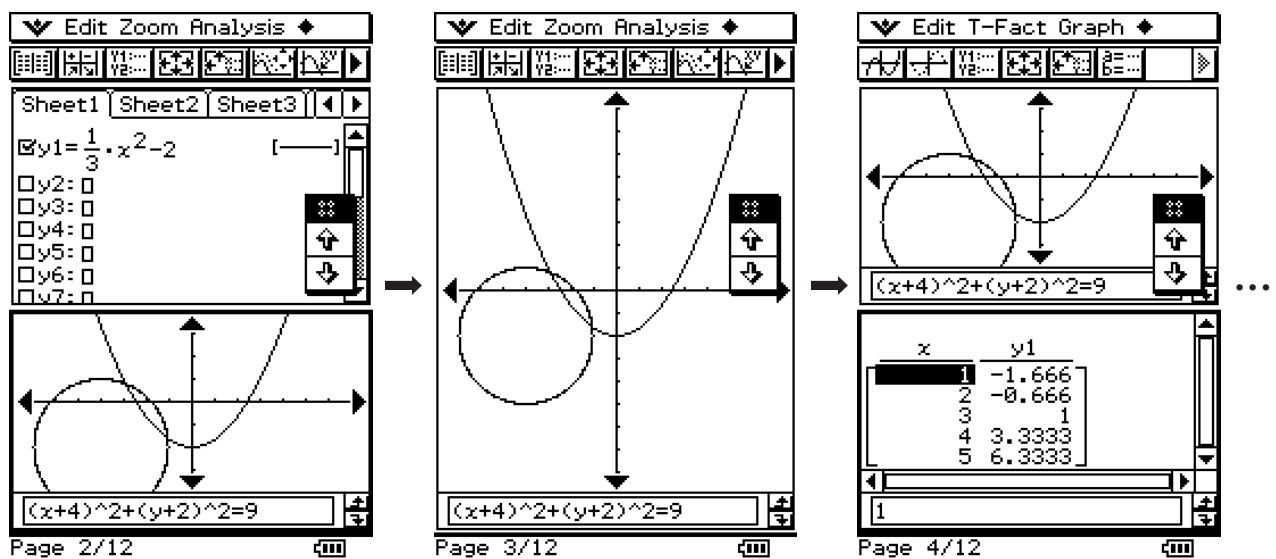

Sample Presentation

Starting Up the Presentation Application

Use the following procedure to start up the Presentation application.

• ClassPad Operation

- On the application menu, tap .

Presentation Application Window

Tapping  on the application menu starts the Presentation application and displays its initial screen.

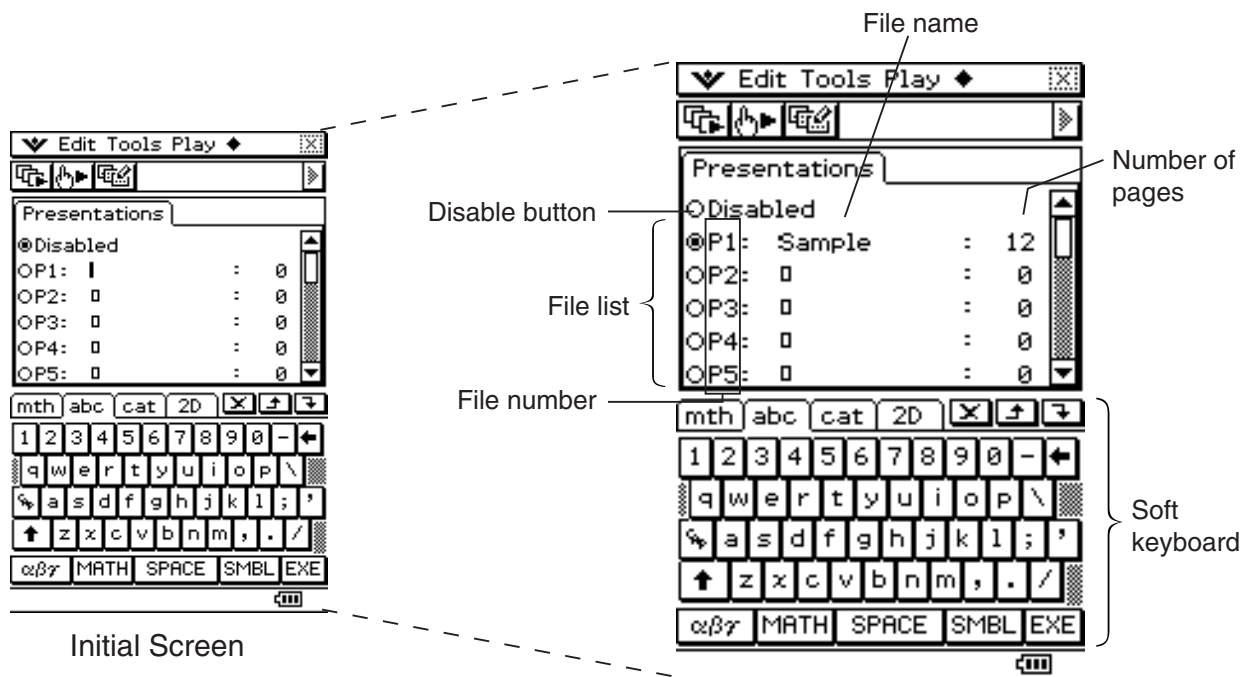



- Selecting [Disabled] will cause the [Screen Copy To] setting on the Presentation and Communication dialog boxes to change automatically to [Outer Device]. For more information, see “11-6 Configuring Presentation Preferences”.
- Files are numbered P1 through P20. These numbers are fixed and cannot be changed. When creating a new presentation file, you can input the file name you want.
- The soft keyboard is automatically displayed when you open the Presentation application.

Presentation Application Menus and Buttons

This section explains the operations you can perform using the menus and buttons of the Presentation application's initial screen.

■ Initial Screen Menu Commands and Buttons

To do this:	Tap this button:	Or select this menu item:
Delete the presentation file whose option button is currently selected (page 11-3-1)	–	Edit - Delete
Delete all presentation files (page 11-3-1)	–	Edit - Delete All
Enter the Editing mode and display the editing tool palette (page 11-5-1)		Tools
Start auto play (page 11-4-1)		Play - AutoPlay
Start manual play (page 11-4-2)		Play - ManualPlay
Insert a white screen at the end of the selected presentation file (page 11-2-3)	–	◆ - White Screen
Append PICT data to the end of the selected presentation file (page 11-2-3)	–	◆ - Add



Screen Capture Precautions

Note the following precautions when capturing screens for a presentation.

- The operation that is performed when you tap  depends on the current [Screen Copy To] setting as described below.

When the [Screen Copy To] setting is this:	Tapping  does this:
Outer Device	Sends the screenshot to an external device.
P1 - P20	Adds the screenshot to the presentation file.

To change the [Screen Copy To] setting, tap , and then [Presentation] or [Communication]. For more information, see “Presentation Dialog Box” on page 1-9-14.

- Tapping  will capture either the full screen or half the screen, depending on how you have Presentation preferences configured. For more information, see “11-6 Configuring Presentation Preferences”.
- Screen capture is disabled when any of the following conditions exists.
 - While a calculation, graph draw, or similar operation is in progress
 - While a data communication operation is in progress
 - While the stylus (or your finger or other object) is in contact with the screen
- In addition to the conditions detailed above, screen capture may be disabled by other operations that have a higher priority than screen capture.
- The status bar is not included in screen captures when [Screen Copy To] setting is “P1” - “P20”.



11-2 Building a Presentation

Presentations are created by capturing screenshots that are produced by the applications of the ClassPad. Before actually beginning to capture the screenshots, it is important to carefully think about and plan the type of information you want to include in your presentation so that your screenshots display the information that you want. This is not to say, however, that you must create a perfect presentation the first time around. You can always change the sequence of pages or edit a pages at any time.

• To create a new presentation



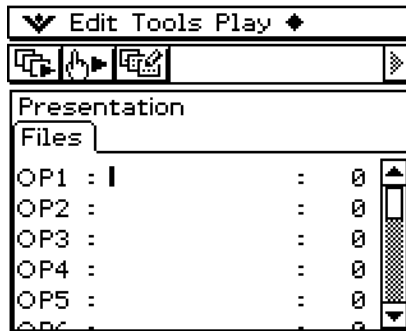

- (1) On the application menu, tap  to start the Presentation application.
- (2) On the file list, tap the line (P1 through P20) where you want to store the new presentation file.
 - This causes a cursor to appear on the line you tap.

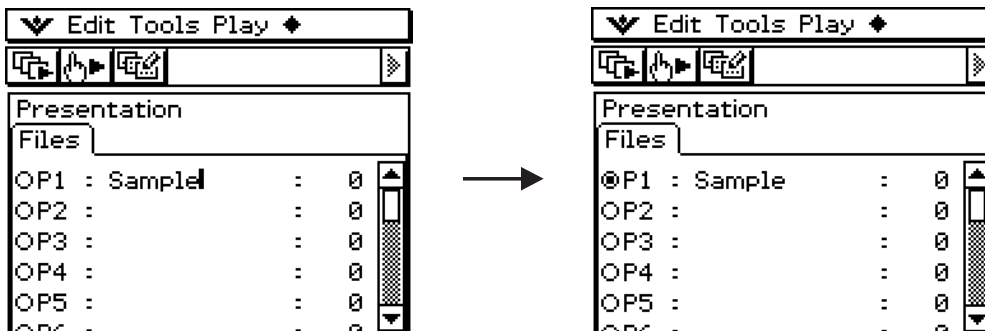

- (3) Enter up to eight bytes for the presentation file name, and then tap .
 - Check to make sure that the file name you just input is selected (button is on).



- (4) Tap  to display the application menu, and then start the application whose screens you want to capture.
- (5) Perform the required operations in the application to display the screen you want to capture.

- (6) With the screen you want to capture on the display, tap  .
- The currently displayed screen is captured as soon as you tap  . Its image is added to the pages of the presentation file you selected in step (3).
 - If the capture is successful, “” appears in the status bar for about one second.
- (7) Repeat steps (5) and (6) to capture other screens as required.
- Note that you can change to other applications as required.
- (8) After capturing all of the images you want, tap  to display the application menu, and then tap  to return to the Presentation application.

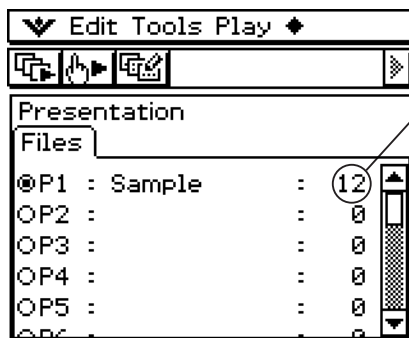

This value shows how many pages (images) you have captured and added to the presentation.

- Even after you return to the Presentation application, you can restart screen capture to add more pages. To do so, simply return to step (4) of this procedure.
- (9) To check the current contents of the presentation, tap  .
- This starts auto play, which scrolls through the pages of the new presentation automatically. For more information, see “Using Auto Play” on page 11-4-1.

Adding a Blank Page to a Presentation

Perform the procedure on page 11-2-3 when you want to add a blank page to the end of a presentation. After adding a blank page, you can put text on it or move it to another location inside the presentation.

You can use blank pages to indicate the end of a presentation, to separate a presentation into sections, or to insert commentary text.



• **To insert a blank page into a presentation**

- (1) On the Presentation application initial screen, tap the button next to the presentation file into which you want to insert the blank page, so it is selected.

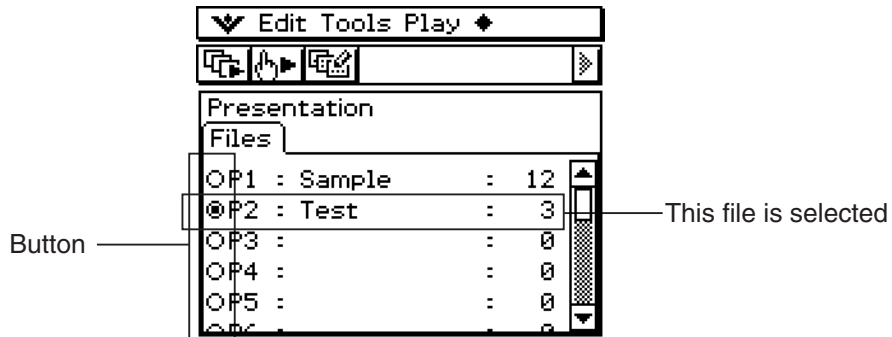

- (2) Tap and then [White Screen].

- This inserts a blank page as the final page of the presentation file you selected in step (1), and increases the number of pages for the presentation by one.

Tip

- For information about inserting text and moving the blank page, see “11-5 Editing Presentation Pages”.

• **To append PICT data to the end of a presentation**

- (1) On the Presentation application initial screen, tap the button next to the presentation file where you want to append the PICT data so it is selected.

- (2) Tap and then [Add].

- This displays the Select Data dialog box.

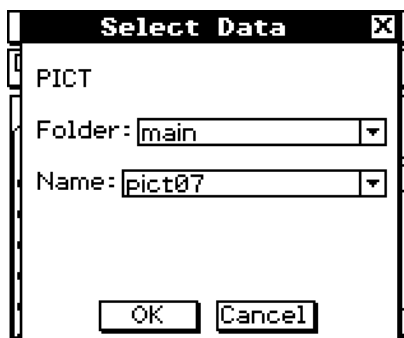

- (3) On the Select Data dialog box, select the folder where the PICT data you want to insert is stored, and specify the name of the data.

- (4) Tap [OK].

- This closes the Select Data dialog box and appends the PICT data to the end of the presentation.

Tip

- If the size of the PICT data is different from the ClassPad display size, the upper left corner of the PICT data is aligned with the upper left corner of the ClassPad display, and any data that does not fit is cut off.

11-3 Managing Presentation Files

After you create a presentation file, you can rename it or delete it.

• To rename a presentation file

- (1) On the Presentation application initial screen, tap the name of the file you want to rename so it is selected.
- (2) Press .
 - This causes a cursor to appear to the right of the last character of the file name.
- (3) Change the file name.
 - A file name can be up to eight bytes long.
- (4) After the file name is the way you want, tap **EXE**.

• To delete a single presentation file

- (1) On the Presentation application initial screen, tap the button next to the name of the file you want to delete so it is selected.
- (2) Tap [Edit] and then [Delete].
- (3) In response to the confirmation message that appears, tap [OK].
 - This deletes the file you selected in step (1).

• To delete all presentation files

- (1) Display the Presentation application initial screen.
- (2) Tap [Edit] and then [Delete All].
- (3) In response to the confirmation message that appears, tap [OK].
 - This deletes all of the presentation files.

- A presentation file is actually a user folder, so presentation files appear as folders on the Variable Manager folder list.

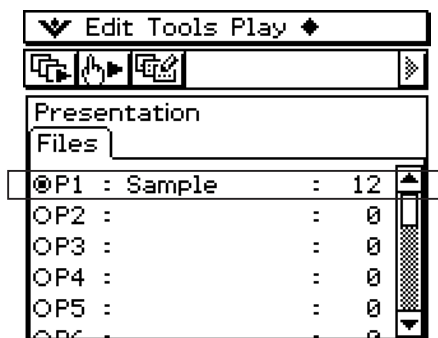

Presentation File List

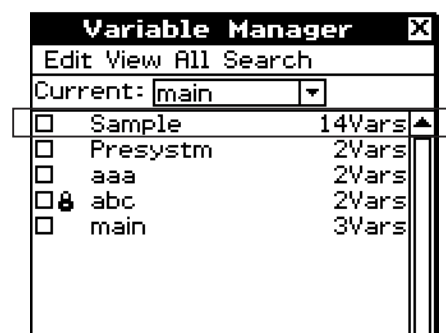

Variable Manager Folder List

For details about using the Variable Manager, see “1-8 Using the Variable Manager”.

Important!

- PICT format image data files (PICT data type variables) captured with the  icon are stored in folder that is created when you create a Presentation file.
- The “Presystm” folder (whose contents you can view with the Variable Manager) contains files for managing presentations. Normally, you should never edit or delete the “Presystm” folder or any of its contents. If these files are damaged or deleted, they will be restored when you run the presentation.



11-4 Playing a Presentation

This section explains the various methods you can use to play a presentation.

Using Auto Play

With auto play, the pages of the presentation are scrolled automatically at a fixed interval.

• ClassPad Operation

- (1) On the Presentation application initial screen, tap the button next to the presentation file you want to play, so it is selected.

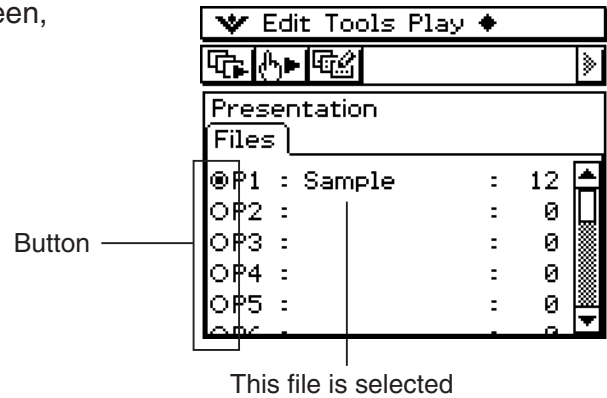

- (2) Tap , or tap [Play] and then [AutoPlay].

- This starts auto play, which displays the pages of the presentation in sequence.

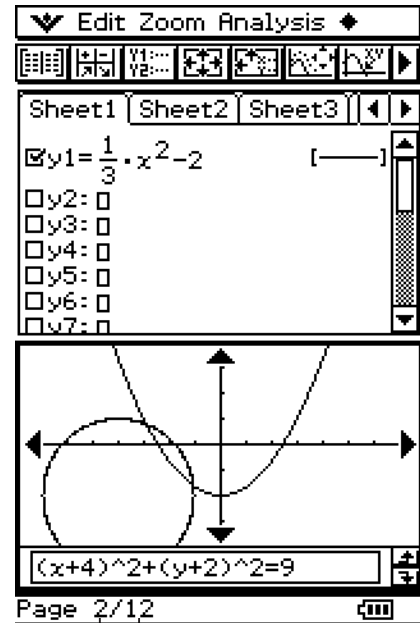

Current page number Total number of pages

- (3) When playback reaches the final page it stops, and then the Presentation application initial screen appears.

- To stop an auto play operation part way through, tap **ESC** on the icon panel or press the **Clear** key.

Tip

- You can configure Presentation preferences to specify the page change speed and to turn page number display in the status bar on or off. For more information, see “11-6 Configuring Presentation Preferences”.
- You can also configure auto play so it repeats when the final page of a presentation is reached. For more information, see “Using Repeat Play” on page 11-4-3.

Using Manual Play



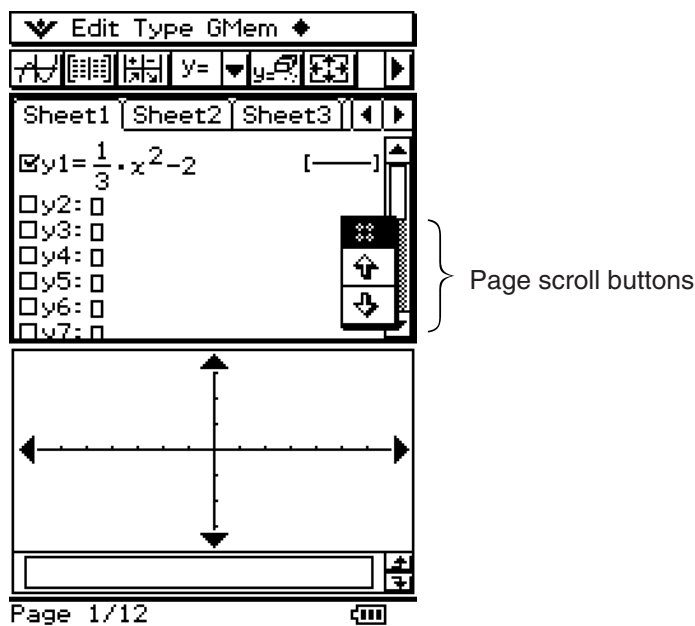

With manual play, you control when page change operations are performed during presentation play. Manual play lets you scroll forward or back through presentation pages, and you can display a pointer on a page.

• **ClassPad Operation**

- (1) On the Presentation application initial screen, tap the button next to the presentation file you want to play, so it is selected.
- (2) Tap , or tap [Play] and then [ManualPlay].
 - This starts manual play, which displays the first page of the presentation.



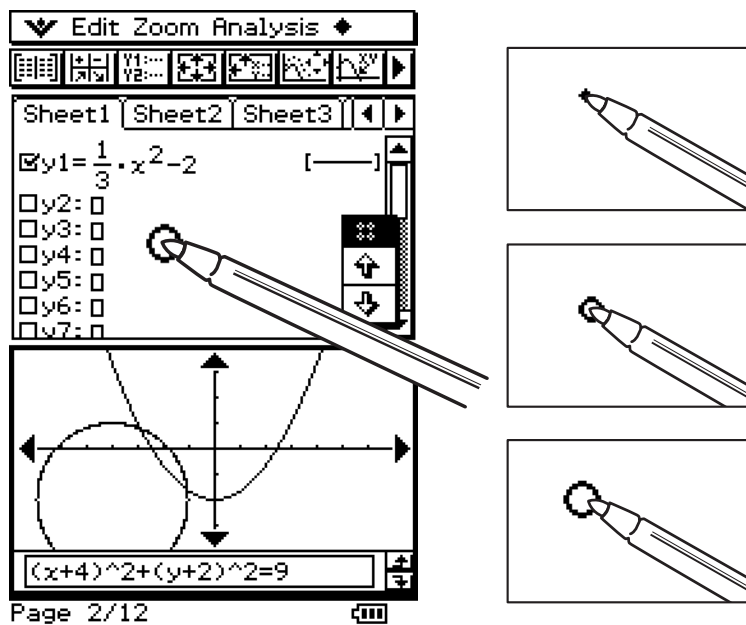

- (3) You can perform the following operations while a manual play operation is in progress.

When you want to do this:	Do this:
Advance to the next page	Tap the  page scroll button or press the  cursor key
Return to the previous page	Tap the  page scroll button or press the  cursor key
Display a round pointer	Hold or drag the stylus on the screen



(4) Tapping  while the final page of the presentation is displayed causes the message “End of Files” to appear in the status bar.

- Tapping  while the message “End of Files” is in the status bar exits the manual play operation and displays the Presentation initial screen. Tapping  while “End of Files” is in the status bar returns you to the final page of the presentation and continues the manual play operation.

Tip

- You can turn display of the page number in the status bar on and off. For more information, see “11-6 Configuring Presentation Preferences”.

Using Repeat Play

Repeat play causes auto play to restarts the presentation from the beginning each time the final page of a presentation is reached.

Use the Presentation dialog box (page 11-6-1) to turn repeat play on or off.

The initial default setting is repeat play off.

The following describes how repeat play works for auto play.

■ Repeat Auto Play













- When the final page of the presentation is reached, the presentation is restarted from the first page.
- The presentation continues playing until you tap **ESC** on the icon panel or press the  key to stop it.

11-5 Editing Presentation Pages

This section explains how to use the Editing mode of the Presentation application to modify the pages of an existing presentation.

About the Editing Tool Palette

An editing tool palette appears on the display whenever you enter the Editing mode. The following describes how to use the editing tool palette.

To do this:	Tap this tool button:
Move the currently displayed page one page back	
Move the currently displayed page one page forward	
Delete the currently displayed page	
Copy the currently displayed page	
Paste a copied page into the location before the currently displayed page	
Delete the lower half of the screen	
Insert text into a page	
Draw a straight line on a page	
Draw an arrow on a page	
Use the eraser	
Save a page after editing it	
Exit the Editing mode and return to the Presentation application initial screen	

Entering the Editing Mode

Perform the following steps to enter the Editing mode when you want to edit the pages of an existing presentation.

• ClassPad Operation

- (1) On the Presentation application initial screen, tap the button next to the presentation file you want to edit, so it is selected.
- (2) Tap , or tap [Tools].
 - This enters the Editing mode and displays the editing tool palette and page scroll buttons. Page 1 of the presentation file you selected in step (1) appears first.

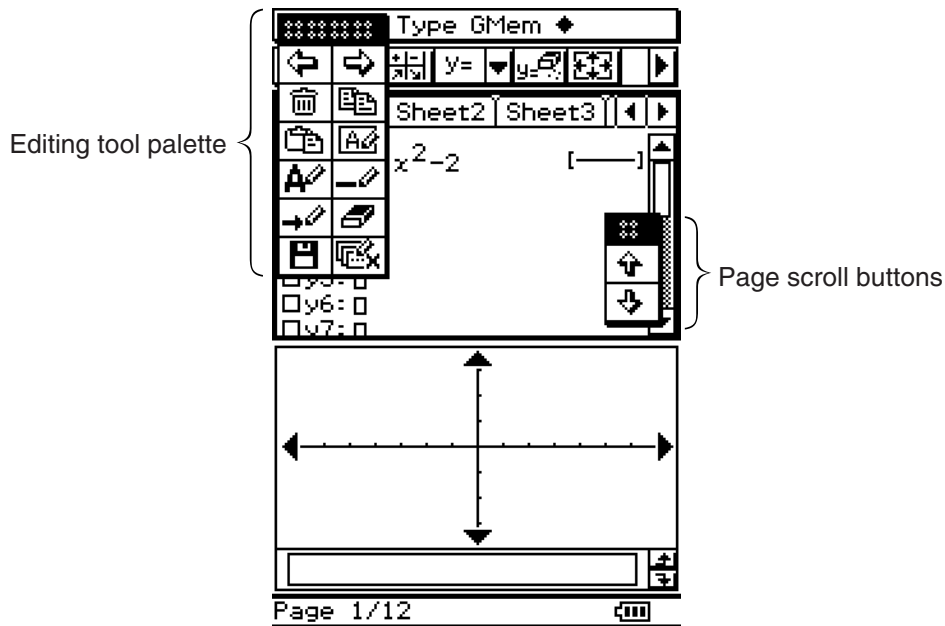

(3) Use the editing tool palette buttons to edit the pages.

- For details about editing operations, see “Editing Operations” on page 11-5-3.
- You can drag the editing tool palette and page scroll buttons to any location on the display. Simply use the stylus to drag the handle of the palette or buttons.

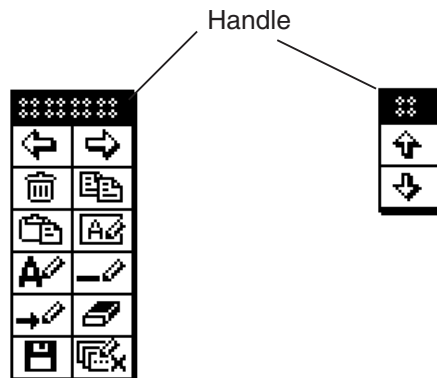





• To exit the Editing mode

On the editing tool palette, tap , or tap **ESC** on the icon panel, or press **Clear** to exit the Editing mode and return to the Presentation application initial screen.

Editing Operations

This section provides details about the page editing operations you can perform with the Presentation application's editing tool palette.

• To move a page

- (1) Enter the Editing mode of the Presentation application (page 11-5-1).
- (2) Use the page scroll buttons to display the page you want to move.
- (3) Tap  to move the currently displayed page back one page, or tap  to move it forward one page.
 - The illustrations below show the effect of tapping  or  while page C of a five-page presentation file is selected.

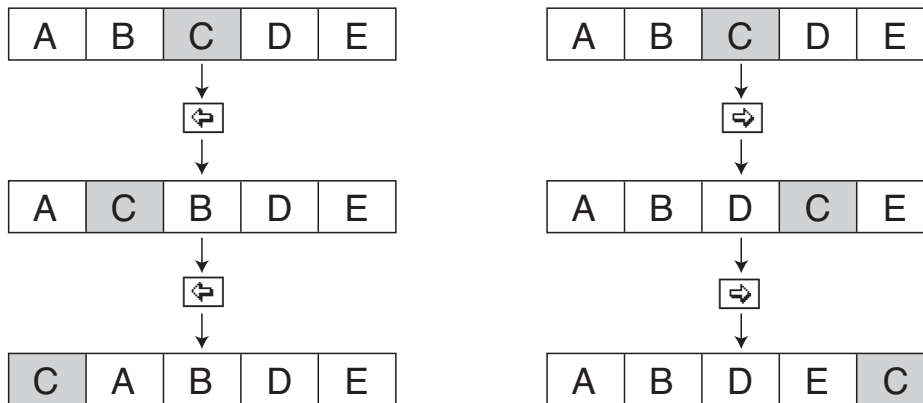

• To delete a page

- (1) Enter the Editing mode of the Presentation application (page 11-5-1).
- (2) Use the page scroll buttons to display the page you want to delete.
- (3) Tap .
- (4) In response to the confirmation dialog box that appears, tap [OK] to delete the page or [Cancel] to cancel.
 - This deletes the currently displayed page and then displays the following page. Deleting the final page of a presentation displays the page preceding the deleted page.



• To copy and paste a page

- (1) Enter the Editing mode of the Presentation application (page 11-5-1).
- (2) Use the page scroll buttons to display the page you want to copy, and then tap .
 - This copies the currently displayed page to the clipboard.
- (3) Use the page scroll buttons to display the page that you want to follow the copied page.
 - The illustrations below show the effect of copying page E of a five-page presentation file and pasting it between pages B and C.

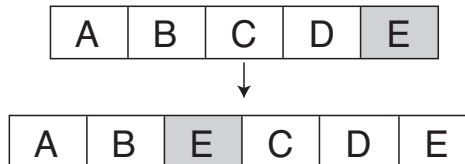

- (4) Tap .
 - This pastes the page at the location in front of the currently displayed page.

• To insert text into a page

- (1) Enter the Editing mode of the Presentation application (page 11-5-1).
- (2) Use the page scroll buttons to display the page into which you want to insert text, and then tap .
 - This displays a text input dialog box along with a soft keyboard.
- (3) Enter the text and then tap [OK].
 - In this example we input the text “full-screen”.
- (4) Place the stylus on the screen and hold it there.
 - This causes the text you input in step (3) to appear at the location where you are pointing with the stylus.
- (5) Drag the text to the location you want, and then lift the stylus from the screen.

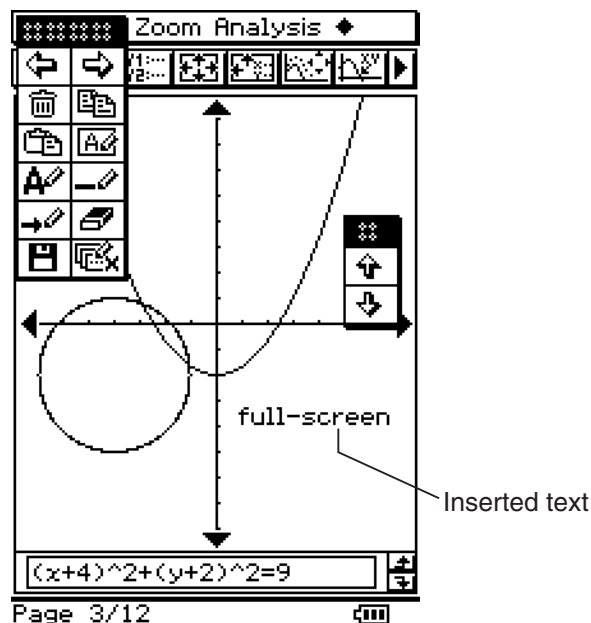

(6) To save the result of the text insert operation, tap  and then tap [OK] on the confirmation dialog box that appears.

• **To clear the bottom half of the screen**

(1) Enter the Editing mode of the Presentation application (page 11-5-1).

(2) Use the page scroll buttons to display the page whose bottom half you want to clear.

(3) Tap .

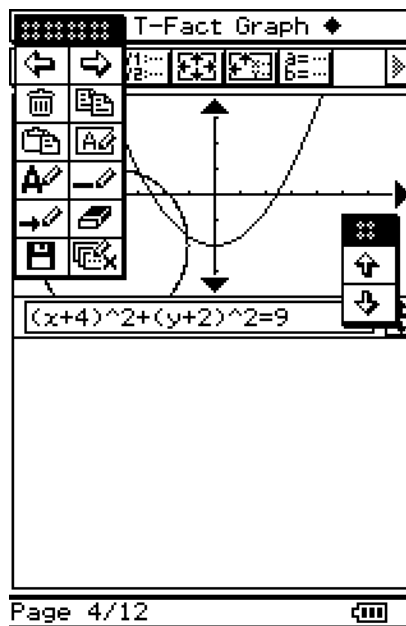

- This clears the bottom half of the displayed page.





(4) To save the result of the operation, tap  and then tap [OK] on the confirmation dialog box that appears.

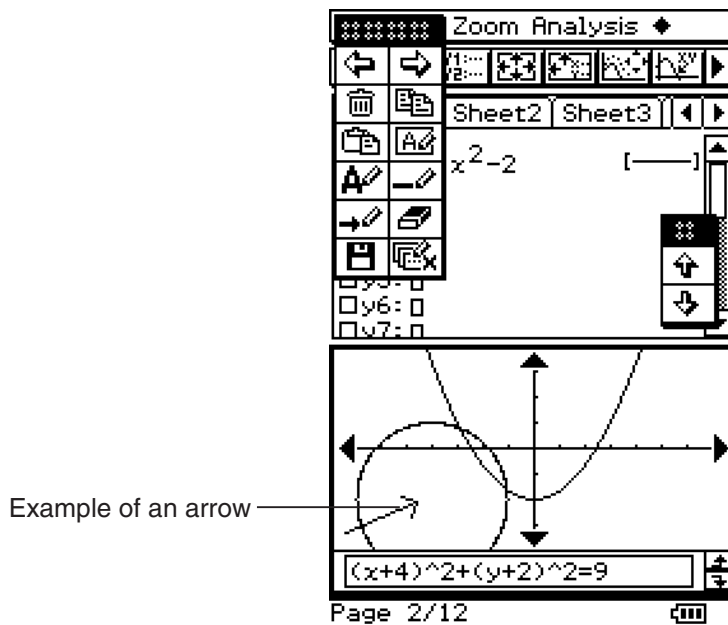

- **To draw a straight line or an arrow on a page**

- (1) Enter the Editing mode of the Presentation application (page 11-5-1).
- (2) Use the page scroll buttons to display the page on which you want to draw a straight line or arrow.
- (3) Tap  if you want to draw a line or  if you want to draw an arrow.
- (4) Tap the point where you want one end of the line segment or arrow to be, and then tap the point where you want the other end to be.
 - A line segment or arrow appears between the points you tapped.
 - If you are drawing an arrow, the arrow head appears on the end you specify last.



- (5) To save the result of the draw operation, tap  and then tap [OK] on the confirmation dialog box that appears.

Using the Eraser

The eraser allows you to erase parts of an image, text, arrows, or lines you have added to a page.

- **To erase part of a page with the eraser**

- (1) Enter the Editing mode of the Presentation application (page 11-5-1).
- (2) Use the page scroll arrows to display the page that contains the figures you want to erase.
- (3) Tap .

Important!

- Whenever the  tool button is selected, dragging the stylus across the screen erases a 3×3 -pixel area (centered on the stylus).
- (4) Drag the eraser across the screen to erase the figures you want.

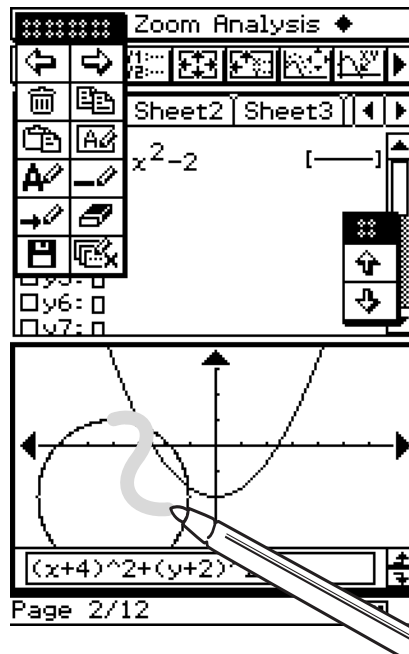

- (5) To save the result of the erase operation, tap , and then tap [OK] on the confirmation dialog box that appears.

11-6 Configuring Presentation Preferences

You can use the procedure below to configure various Presentation application preferences.



• ClassPad Operation

(1) Tap , and then [Presentation].

- This displays the Presentation dialog box.



(2) Use the Presentation dialog box to configure the preferences you want.

To do this:	Do this:
Send hard copy data generated by tapping  to an external device	Select [Outer Device].*
Save hard copy data internally as Presentation data	Select "P1:<File name>*" through "P20:<File name>*" for [Screen Copy To].
Specify the page change speed for Auto Play	Specify a [Play Speed] value from 1 (fastest) to 10 (slowest).
Capture the upper half of the screen when  is tapped	Select the [Half Screen Capturing] check box.
Capture the entire screen when  is tapped	Clear the [Half Screen Capturing] check box.*
Turn on repeat playback of files during Auto Play	Select the [Repeat] check box.
Turn off repeat playback of files during Auto Play	Clear the [Repeat] check box.*
Turn on page number display during playback and editing	Select the [Page Number] check box.*
Turn off page number display during playback and editing	Clear the [Page Number] check box.

- Items marked with an asterisk (*) are initial defaults. The initial default [Play Speed] setting is 4.
- Selecting [Disabled] on the Presentation application initial screen will cause the [Screen Copy To] to change automatically to [Outer Device].

** <File name> will show the name of the presentation file.

(3) To close the dialog box and apply its settings, tap [Set]. To close the dialog box without applying its settings, tap [Cancel] or the  button in the upper right corner of the dialog box. To restore all the settings on the dialog box to their initial defaults, tap [Default].

Tip

- The following examples show the area of the screen that is captured when you tap  while the [Half Screen Capturing] check box is selected. The captured areas are indicated by the thick boundaries in each example.

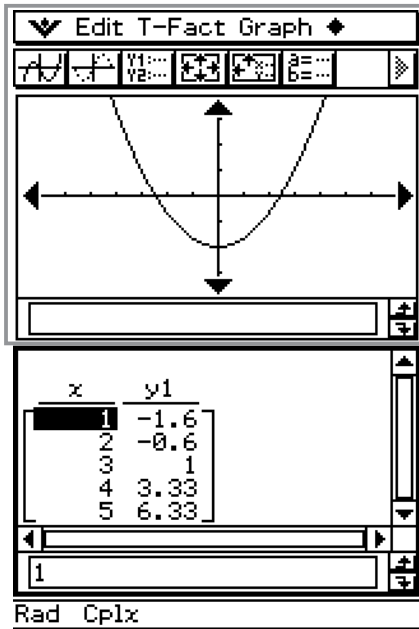

Sample Screenshot

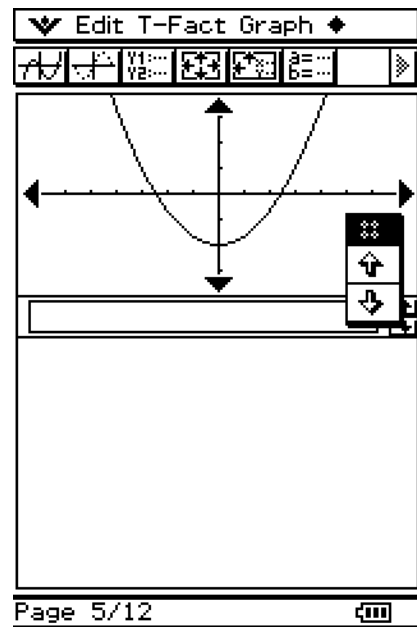

Captured Image Data

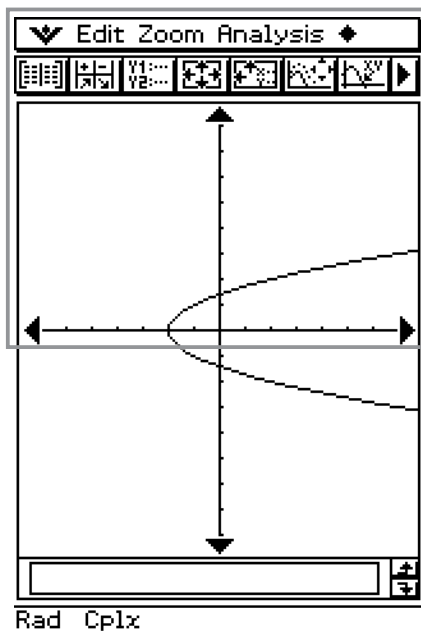

Sample Screenshot

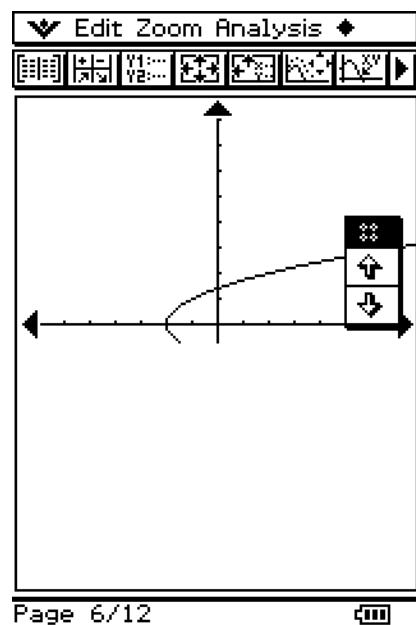

Captured Image Data

11-7 Presentation File Transfer

A presentation file is actually a kind of user folder (called a “presentation folder”) that contains the images that make up the presentation. This folder may be transferred to another ClassPad unit or a computer in order to play the presentation.

Caution

- A presentation created with Version 3.0 of the ClassPad software cannot be played on a ClassPad or a computer that is running an earlier version.



Chapter 12

Using the Program Application

The Program application comes in handy when you need to perform the same calculation a number of times. You can create programs that automate graphing and other operations.

- 12-1 Program Application Overview**
- 12-2 Creating a New Program**
- 12-3 Debugging a Program**
- 12-4 Managing Files**
- 12-5 User-defined Functions**
- 12-6 Program Command Reference**
- 12-7 Including ClassPad Functions in Programs**

12

12-1 Program Application Overview

The Program application consists of a Program Editor for inputting and editing programs, and a Program Loader for loading and executing existing programs.

Starting Up the Program Application

Use the following procedure to start up the Program application.

- **ClassPad Operation**

On the application menu, tap  .

This starts the Program application and displays the Program Loader window.

Program Loader Window







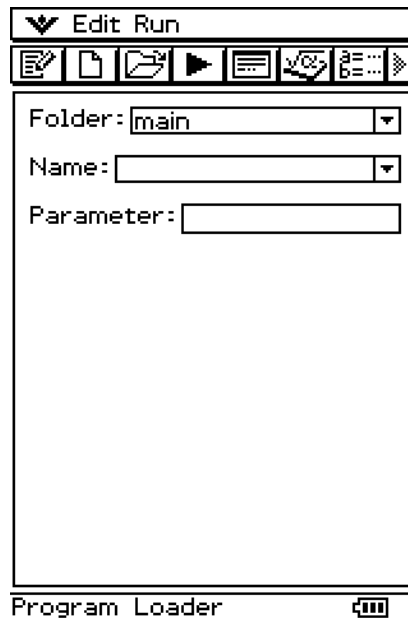

Use the Program Loader window to recall and run existing programs.

- **To display the Program Loader window**

On the application menu, tap  to start up the Program application. The Program Loader window appears when you start up the Program application.



■ Program Loader Window Menus and Buttons



To do this:	Tap this button:	Or select this menu item:
Display the Program Loader window	—	▼ - Program Loader
Display the Program Editor window		▼ - Program Editor
Display the Program Output window		▼ - Program Output
Display the Text File Contents window	—	▼ - Text File Contents
Display the Main application work area window		▼ - Main
Display the Program Editor window		Edit - Open Editor
Create a new file		Edit - New File
Open an existing file		Edit - Open File
Clear the screen	—	Edit - Clear All
Run a program		Run - Run Program
Display the Variable Manager (page 1-8-1)		▼ - Variable Manager



Program Editor Window

You can use the Program Editor window to input a new program or to edit an existing program. You can also use the Program Editor window to input and edit user-defined functions.





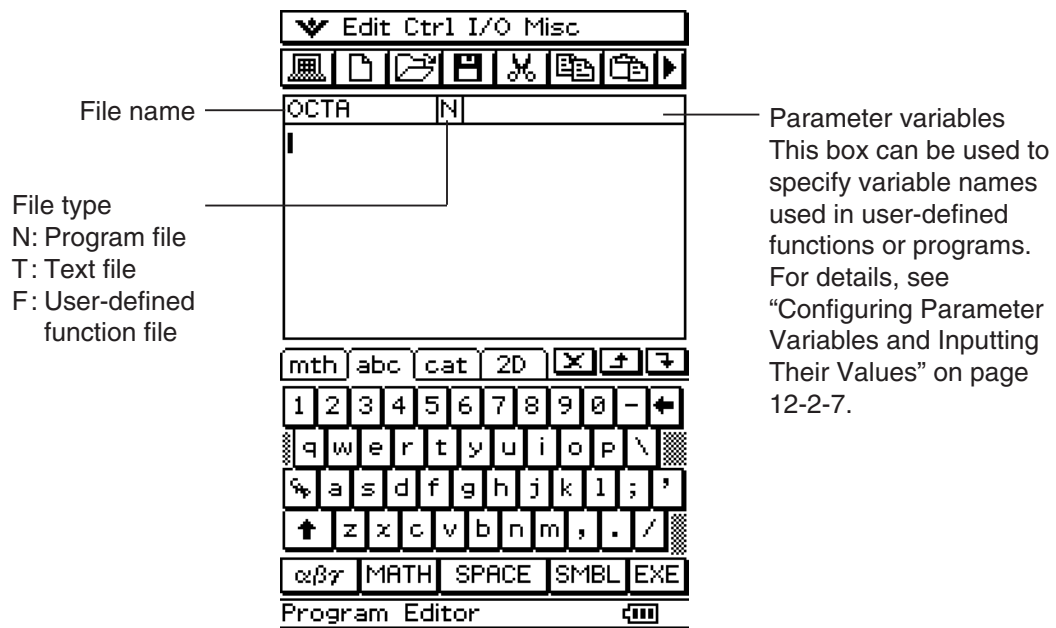





• To display the Program Editor window

- (1) On the application menu, tap  to start up the Program application.
- (2) On the window that appears, tap , or tap  and then [Program Editor].



■ Program Editor Window Menus and Buttons

The following describes the menu and button operations you can perform on the Program Editor window.

To do this:	Tap this button:	Or select this menu item:
Display the Program Loader window		▼ - Program Loader
Display the Program Editor window	—	▼ - Program Editor
Display the Program Output window		▼ - Program Output
Display the Text File Contents window	—	▼ - Text File Contents
Display the Main application work area window	—	▼ - Main
Close the currently active window	—	▼ - Close
Create a new file		Edit - New File
Open an existing file		Edit - Open File
Save a file		Edit - Save File
Save a file under a new name	—	Edit - Save As
Close a file	—	Edit - Close File
Convert a file to a program file	—	Edit - Mode Change - ►Normal
Convert a file to a text file	—	Edit - Mode Change - ►Text
Convert a file to an edit prohibited program file	—	Edit - Compress
Put a selection onto the clipboard and delete the original		Edit - Cut
Put a selection onto the clipboard without affecting the original		Edit - Copy
Paste the clipboard contents		Edit - Paste
Select everything on the screen	—	Edit - Select All
Search for a newly specified text string		Edit - Search - New Search
Search again for a previously specified text string		Edit - Search - Search Next
Jump to the beginning of a program	—	Edit - Search - Jump to Top
Jump to the end of a program	—	Edit - Search - Jump to Bottom
Clear the contents of the Program Editor window	—	Edit - Clear All
Display the Variable Manager (page 1-8-1)		▼ - Variable Manager



To do this:	Select this submenu item:	Select this menu item:
Input a command from the [Ctrl] menu • For details about each command, see “12-6 Program Command Reference”.	Ctrl - :	—
	Ctrl - ⇒	—
	Ctrl - Jump	Lbl, Goto
	Ctrl - If	If, Then, Elseif, Else, IfEnd
	Ctrl - For	For, To, Step, Next
	Ctrl - Do	Do, LpWhile
	Ctrl - While	While, WhileEnd
	Ctrl - Switch	Switch, Case, Default, SwitchEnd
	Ctrl - Control	Skip, Return, Break, Stop, Wait, Pause
	Ctrl - Logic	=, ≠, <, >, ≤, ≥, and, or, xor, not
Ctrl - Misc	’, ”, Define	
Input a command from the [I/O] menu • For details about each command, see “12-6 Program Command Reference”.	I/O - Input	Input, InputStr, InputFunc, GetKey, GetPen
	I/O - Output	Print, Locate, Message, PrintNatural
	I/O - Display	DispText, DispFTable, DispSmryTbl, DispSeqTbl, DispDfrTbl, DispQutTbl, DispDQTbl, DispFibTbl, DispListEditor, DispStat
	I/O - Draw	DrawGraph, DrawShade, DrawFTGCon, DrawFTGPlot, DrawSeqCon, DrawSeqPlt, DrawSeqEtrCon, DrawSeqEtrPlt, DrawConics, Draw3D, DrawStat
	I/O - Sketch	Plot, PlotChg, PlotOff, PlotOn, plotTest, PxlChg, PxlOff, PxlOn, pxlTest, Distance, Line, Circle, Horizontal, Vertical, TangentLine, NormalLine, Inverse, Text
	I/O - Clear	Cls, ClrText, ClrGraph
	I/O - Communication	OpenComPort38k, CloseComPort38k, Send38k, Receive38k, SendVar38k, GetVar38k



To do this:	Select this submenu item:	Select this menu item:
Input a command from the [Misc] menu <ul style="list-style-type: none"> • For details about each command, see “12-6 Program Command Reference”. 	Misc - Statistics(1)	StatGraph, StatGraphSel, Scatter, xyLine, NPPlot, Histogram, MedBox, ModBox, NDist, Broken, LinearR, MedMed, QuadR, CubicR, QuartR, LogR, ExpR, abExpR, PowerR, SinR, LogisticR
	Misc - Statistics(2)	Square, Cross, Ldot, Dot, DefaultListEditor
	Misc - Graph&Table(1)	GraphType, GTSelOn, GTSelOff, SmryTSelOn, ViewWindow, LogP, CallUndef, ZFactor, ZAuto, PTCross, PTDot, PTNormal, PTSquare, PTBrokenThck, PTThick, SheetActive, SheetName, ClearSheet
	Misc - Graph&Table(2)	StoGMem, StoPict, StoVWin, RclGMem, RclPict, RclVWin
	Misc - Sequence	SeqSelOn, SeqSelOff, SeqType
	Misc - 3D Graph	SelOn3D, SheetName3D, SheetActive3D, ViewWindow3D, ClearSheet3D
	Misc - Variable	NewFolder, DelFolder, LockFolder, UnlockFolder, GetFolder, SetFolder, MoveVar, CopyVar, Rename, DelVar, Clear_a_z, Lock, Unlock, GetType, Local
	Misc - String	ChrToNum, ExpToStr, NumToChr, NumToStr, StrJoin, StrCmp, StrInv, StrLeft, StrLen, StrLwr, StrMid, StrRight, StrRotate, StrShift, StrSrc, strToExp, StrUpr, #



To do this:	Select this submenu item:	Select this menu item:
Input a command from the [Misc] menu • For details about each command, see “12-6 Program Command Reference”.	Misc - Setup(1)	On, Off, DefaultSetup, SetStandard, SetDecimal, SetReal, SetComplex, SetDegree, SetGrad, SetRadian, SetNormal, SetFix, SetSci
	Misc - Setup(2)	SetDrawCon, SetDrawPlt, SetSimulGraph, SetDispGCon, SetAxes, SetBG, SetCoord, SetDeriv, SetFunc, SetGrid, SetLabel, SetLeadCursor, SetTVariable, TableInput, SetSmryTable, VWin, SetSmryTableQD
	Misc - Setup(3)	SetStatWinAuto, SetCellWidth, SetSequence, StepDisp, Set Σ disp, SetAxes3D, Box, SetCoordOff3D, SetCoordPol3D, SetCoordRect3D, SetLabel3D





12-2 Creating a New Program

This section explains the steps you need to perform in order to create a new program.

General Programming Steps

The following are the general steps for creating and running a program.

1. Open a new file.
 - Tap , or select the [Edit] menu and then [New File].
2. Input a name and tap [OK].
3. Input the expressions and commands that make up the program.
4. Input display commands as required into the program.
If you do not include display commands in your program, calculation results will not appear on the display.
5. Save the program.
6. Display the Program Loader window by tapping .
7. Run the program by tapping , or by selecting the [Run] menu and then [Run Program].

Creating and Saving a Program

Example: To create a program named “OCTA” that calculates the surface areas (cm^2) and volumes (cm^3) of three regular octahedrons, the lengths of whose sides are 7, 10, and 15 cm

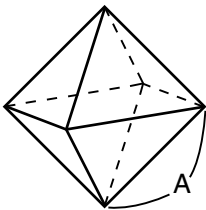



The following formulas calculate the surface area S and volume V of a regular octahedron for which the length of side A is known.

$$S = 2\sqrt{3}A^2, \quad V = \frac{\sqrt{2}}{3}A^3$$



• ClassPad Operation

- (1) Tap  to display the application menu, and then .
- (2) Tap , or tap [Edit] and then [New File].
- (3) Configure the settings for the new file as described below.

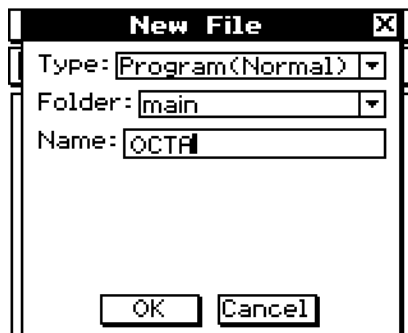

- Leave the [Type] setting as “Program(Normal)”.
 - Tap the [Folder] down arrow button and then select the name of the folder where you want to save the program file.
 - In the [Name] box, use the soft keyboard to input up to eight bytes for the program file name.
- (4) Tap [OK].
 - (5) Input the necessary expressions and commands.

- Each mathematical expression and command must be followed either by a carriage return or colon (:).

- **To input the “SetDecimal” command**



On the menu bar, tap [Misc], [Setup(1)] and then [SetDecimal].

- **To input the “Input” and “Print” commands**

On the menu bar, tap [I/O] and then select the command you want to input.

[I/O] [Input] [Input]
[I/O] [Output] [Print]

- **To input the variable name “A”**

On the soft keyboard  tab, tap  and then .

- **To input a carriage return**

Tap  or press .

Inputting a carriage return causes the cursor to move to the beginning of the next line. No carriage return symbol appears on the display.

- **To input values and symbols**

On the soft keyboard  tab, tap the value or symbol you want.

OCTA		N
SetDecimal		
Input A		
Print approx(2*sqrt(3)*A^2)		
Print approx(sqrt(2)/3*A^3)		



(6) After the program is the way you want, tap , or tap [Edit] and then [Save File] to save it.

- To run this program see “Running a Program” on page 12-2-5.
- If a message appears when you try to save the program, make the necessary corrections and try again. For details about making corrections to a program, see “12-3 Debugging a Program”.

Tip

- The file name you input in step (3) of the above procedure is subject to the same rules as folder names. For more information, see “Folder Name Rules” on page 1-7-5.
- Tapping [Cancel] in step (3) of the above procedure returns you to the Program Editor window.
- To input a program and save it without running it, perform the above procedure up to step (6), and then tap [Edit] and then [Close File].
- When you close a program containing changes since you last saved the file, a dialog box appears asking if you would like to save your changes.
- If the “WARNING! Save changes?” dialog box appears, perform one of the operations described below.

To do this:	Tap this button:
Save and close the program	Yes
Close the program without saving	No
Return to the Program Editor window without saving the program	Cancel

Tapping [Yes] or [No] causes the message “No File” to appear on the display.

- You can use a calculation result obtained within a program in another calculation by using the \Rightarrow command to assign the result to a variable. Then simply include the variable name in subsequent calculations. Note that calculation results produced within programs are not stored in Ans memory.



■ Specifying the File Type

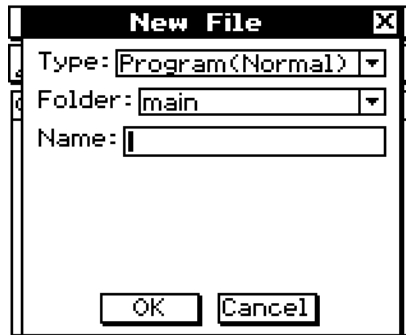

Tapping  or tapping [Edit] and then [New File] on the Program Editor window displays the dialog box shown above.

Tap the [Type] down arrow button and then select one of the options described below from the list of options that appears.

To specify this type of file:	Select this option:
Program file	Program(Normal)
Text file	Program(Text)
User-defined function file	Function

Tip

- For information about text files, see “Using Text Files” below.
- For information about user-defined functions, see page 12-5-1.
- Program files can be converted to text files, and vice versa. For more information, see “12-4 Managing Files”.

■ Using Text Files

- Running a text file from the Program Loader window displays the contents of the file.
- Inserting a text file name inside a program causes the contents of the text file to be displayed when execution reaches the name.

Example:

```
CAUTION | T |
Be sure to check angle
unit setting!
```

File Name: “CAUTION”

```
bas | N |
CAUTION()
Input A
Print approx(sin(A))
```

Program that displays contents of “CAUTION” file







Running a Program

The following procedure shows how to run the sample program we input under “Creating and Saving a Program” on page 12-2-1.

• ClassPad Operation

(1) Display the Program Loader window.

- From the Program Editor window, tap , or tap  and then [Program Loader].
- From another application, tap  and then .
- This causes the Program Loader window to appear.

(2) Tap the [Folder] down arrow button, and then select the name of the folder you want.

(3) Tap the [Name] down arrow button, and then tap the name of the file you input in step (3) of the example on page 12-2-2.

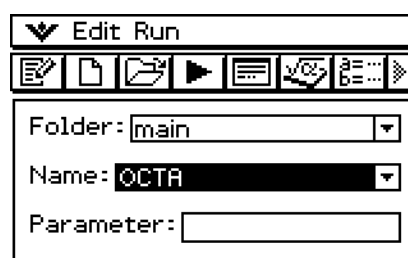

(4) Tap , or tap [Run] and then [Run Program] to run the program.

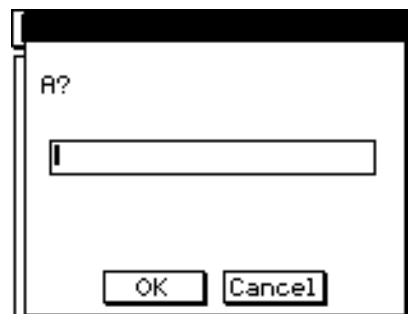

(5) Input a side length of 7 and tap [OK] twice.

7 [OK] [OK]

(6) Tap the Program Loader window and repeat steps (4) and (5) for sides of length 10 and 15.

 10 [OK] [OK]

 15 [OK] [OK]

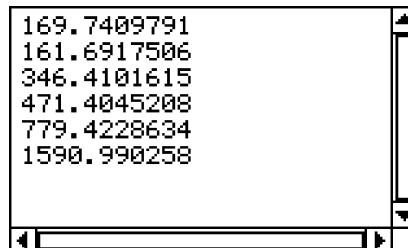

Tip

- In step (4) of the above procedure, you can specify parameters before running the program. For more information, see “Configuring Parameter Variables and Inputting Their Values” on page 12-2-7.
- You can run a program from the Main application or the eActivity application. For more information, see “2-13 Running a Program in the Main Application.”

Pausing Program Execution

You can specify where execution of a program should pause by including either a **Pause** command or a **Wait** command inside the program.

■ Using the Pause Command

A **Pause** command causes program execution to pause when it reaches that point. To resume program execution, tap the  button on the right side of the status bar (which will also cause the button to disappear).

Example

OCTA	N
SetDecimal	
Input A	
Print approx($2 \times \sqrt{3} \times A^2$)	
Pause	
Print approx($\sqrt{2} / 3 \times A^3$)	

■ Using the Wait Command

The syntax of the **Wait** command is: Wait <seconds>. When program execution reaches the **Wait** command, it pauses for the specified number of seconds and then resumes automatically. If you do not specify a value for the number of seconds, execution remains paused until you tap the screen or press a key.





Tip

- To input the **Pause** or **Wait** command, tap [Ctrl] on the menu bar, tap [Control], and then select the command you want.

Terminating Program Execution

Pressing  while a program is running terminates the program.

Tip

- Pressing  does not terminate the program if program execution is already paused by the **Pause** command (indicated by  on the status bar). In this case, tap  to resume program execution, and then press .



Configuring Parameter Variables and Inputting Their Values

If you input the names of variables used in a program into the parameter variable box when inputting or editing a program on the Program Editor window, you will be able to input values for the variables on the Program Loader window when you run the program.

Example

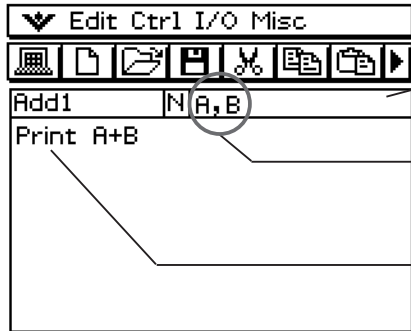

Parameter variable box

Indicates variables named "A" and "B" are used within the program.

When running the program, inputting values for "A" and "B" calculates the total of the two values.

Program Input

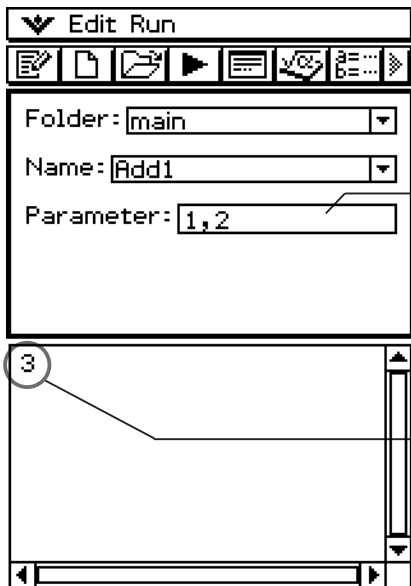

Parameter value input box

Inputting 1, 2 before running the program assigns A = 1 and B = 2.

Executing the program produces the result $A + B = 1 + 2 = 3$.

Program Loader window

Tip

- When running a program that includes parameter variables, be sure to correctly specify the values of the parameters. An error will occur if the number of values you input is not consistent with the number of parameter variables.

Local Variables

A local variable is a variable that can be created temporarily and used in a program. Use the **Local** command to create a local variable.

Syntax: Local □ <variable name> (□ indicates a space.)

Example: Local abc
The above creates a local variable named “abc”.

Tip

- Local variables are deleted automatically after execution of a program is complete.
- Note that local variables are stored in their own special folder, so local variable names do not affect the names of other variables in ClassPad memory. Because of this, you do not need to worry if you assign a local variable a name that is already being used by another type of variable.
- Variables that are specified as parameter variables within a program are automatically treated as local variables. Variables created with the **Define** command are also automatically treated as local variables.

Using Subroutines

Including the name of another program file inside of a program causes execution to jump to the specified program file. The program that execution jumps from is called the “main program”, while the program to which execution jumps is called a “subroutine”.

When program execution returns to the main program, it resumes from the point immediately after the command that jumped to the subroutine.

Tip

- Note that any program can be a subroutine. The thing that makes any program a subroutine is being jumped to from another program.

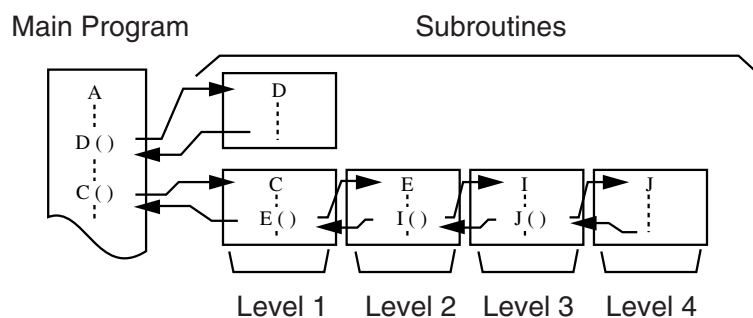

Subroutines can be used in a variety of ways to help make calculations easier. Let's say you have a formula that needs to be calculated more than once in a program, or that needs to be calculated by a number of different programs. Simply store the formula as a separate program file (subroutine), and then you can jump to the program file that contains the formula whenever you need it.

Example 1: Jumping to a subroutine without assigning values to the subroutine's parameter variables

Main Program

Input A

Input B

Sub1() ← Jumps to subroutine program "Sub1"

Print C

Subroutine (Program Name: "Sub1")

$A+B \Rightarrow C$

Return

Example 2: Jumping to a subroutine while assigning values to the subroutine's parameter variables

- In this example, the main program assigns values to parameter variable "E" in a subroutine named "Sub1", and to parameter variables "F" and "G" in a subroutine named "Sub2".

Main Program

Input A

Input B

Sub1(A) ← Assigns the value of main program variable "A" to the parameter variable (E) in subroutine "Sub1", and then jumps to subroutine "Sub1".

Print C

Sub2(A,B) ← Assigns the values of main program variables "A" and "B" to the parameter variables (F and G) in subroutine "Sub2", and then jumps to subroutine "Sub2".

Print D

Subroutine Program 1 (Program Name "Sub1")

$E \times 2 \Rightarrow C$ ← Requires input of variable name E into the parameter variable box.

Return

Subroutine Program 2 (Program Name "Sub2")

$F + G \Rightarrow D$ ← Requires input of variable names F and G into the parameter variable box.

Return

Tip

- The subroutine does not need to be located in the current folder. To specify a subroutine named "Sub1" that is located in a folder named "f1", for example, you would specify "f1\Sub1()".



12-3 Debugging a Program

A programming error that causes a program to behave in a manner not intended by the writer of the program is called a “bug”. Finding and eliminating such errors is called “debugging the program”.

Any of the following conditions can indicate that your program has a bug and requires debugging.

- If an error message appears when you try to save the program
- If an error message appears when you try to run the program
- When a program produces some abnormal or unexpected result

Debugging After an Error Message Appears

When an error occurs, a dialog box appears to explain the cause of the error. Carefully read the text of the error message and then tap its [OK] button. This closes the dialog box and positions the cursor on at the location where the error occurred. Make the necessary corrections in accordance with the explanation provided by the error message.

Tip

- If the cause of the error cannot be specified for some reason, tapping [OK] on the error message dialog box displays the Program Loader window, without positioning the cursor at the location of the error.
- In the case of a program for which editing is prohibited (a program for which “EXE” is indicated as the variable data type), tapping [OK] on the error message dialog box displays the Program Loader window, without positioning the cursor at the location of the error.

Debugging a Program Following Unexpected Results

If execution of a program produces unexpected or abnormal results, carefully read through the program and correct errors as required.

The following commands can come in handy when debugging a program to locate unexpected results.

To do this:	Execute this command:
Move the cursor to the beginning of the program	Edit - Search - Jump to Top
Move the cursor to the end of the program	Edit - Search - Jump to Bottom



Modifying an Existing Program to Create a New One

You can use the procedure described below to recall an existing program, modify it, and then run the result as a new program. This helps reduce key input requirements.

The following shows how to modify the “OCTA” program we created on page 12-2-1 to handle tetrahedrons.

Example: To create a program named “TETRA” that calculates the surface areas (cm²) and volumes (cm³) of three regular tetrahedrons, the lengths of whose sides are 7, 10, and 15 cm

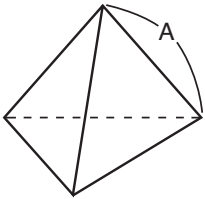

The following formulas calculate the surface area S and volume V of a regular tetrahedron for which the length of one side A is known.

$$S = \sqrt{3} A^2, \quad V = \frac{\sqrt{2}}{12} A^3$$

The following is the program required for this example.

```
Length of One Side A.....Input A
Surface Area S.....Print approx( $\sqrt{3} \times A^2$ )
Volume V .....Print approx( $\frac{\sqrt{2}}{12} \times A^3$ )
```



The following is the “OCTA” program (page 12-2-1).

```
Length of One Side A.....Input A
Surface Area S.....Print approx(2 ×  $\sqrt{3} \times A^2$ )
Volume V .....Print approx( $\sqrt{2} \div$  3 × A3)
```

A comparison of the two programs indicates that the following modifications of the “OCTA” program will produce a program that performs the calculations required by this example.

- Delete “2×” (underlined with a wavy line above).
- Change 3 to 12 (underlined with double lines above).

• ClassPad Operation

- (1) On the application menu, tap .
- (2) Tap , or tap [Edit] and then [Open File].

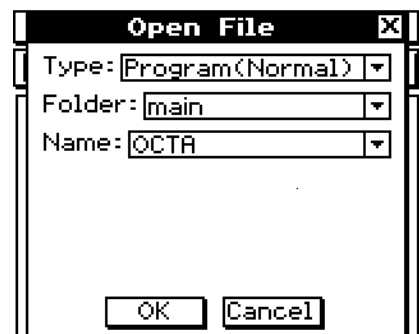

(3) Select the program you want to open and edit, as described below.

For this setting:	Do this:
Type	Tap the down arrow button, and then select "Program(Normal)".
Folder	Tap the down arrow button, and then select the folder that contains the program you want to edit.
Name	Tap the down arrow button, and then select the name of the program you want to open (OCTA).



(4) Tap [OK].

```
OCTA  N
SetDecimal
Input A
Print approx(2*sqrt(3)*A^2)
Pause
Print approx(sqrt(2)/3*A^3)
```

(5) Edit expressions and commands as required.

- a. Change $2 \times \sqrt{3} \times A^2$ to $\sqrt{3} \times A^2$
- b. Change $\sqrt{2}/3 \times A^3$ to $\sqrt{2}/12 \times A^3$
- c. Delete Pause

• **To delete data**

Use the cursor key to move the cursor to the data you want to delete, and then press . Or, highlight the data you want to delete and press .

• **To input data**

Use the cursor key or stylus to move the cursor to the location where you want to insert data, and then use the soft keyboard or the keypad to make the changes you want.

(6) Save the new program.



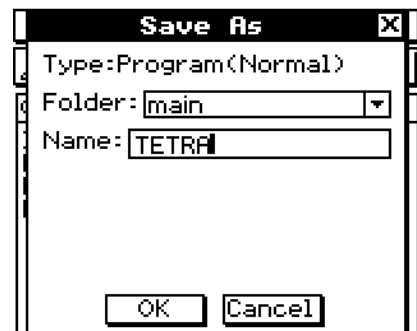

• **To retain the original program and save the new program under a different name**

- Tap [Edit] and then [Save As].
- Use the soft keyboard to type the name you want to assign to the new program into the [Name] box.
- Tap [OK].



• **To replace the original program with the new program**

- Tap , or tap [Edit] and then [Save File].

- (7) After saving the program, tap , or tap  and then [Program Loader] to display the Program Loader window.
- (8) On the dialog box that appears, tap the [Name] down arrow button, and then tap the name of the file you input in step (6) (TETRA).
- (9) Tap , or tap [Run] and then [Run Program].
 - This runs the program.
- (10) Input 7 for the length of side A and tap [OK] twice.
7 [OK] [OK]
- (11) Repeat steps (9) and (10) for sides of length 10 and 15.
 10 [OK] [OK]
 15 [OK] [OK]

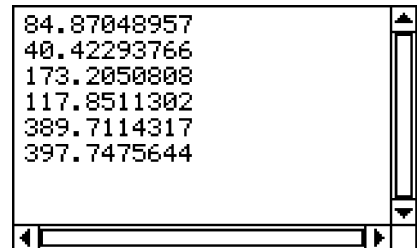

Tip

- To edit a program and save it without running it, perform the above procedure up to step (7), and then tap [Edit] and then [Close File]. If the “WARNING! Save changes?” dialog box appears, perform one of the operations described below.

To do this:	Tap this button:
Save and close the program	Yes
Close the program without saving	No
Return to the Program Editor window without saving the program	Cancel

Tapping [Yes] or [No] causes the message “No File” to appear on the display.







Searching for Data Inside a Program

You can search for data inside a program by specifying a keyword.

Example: To search for the letter “A” within the “OCTA” program

• ClassPad Operation

- (1) From the Program Editor window, select the program you want to search (“OCTA” in this example).
- (2) Tap [Edit], [Search], and then [New Search]. Or, tap  to scroll the toolbar and tap .
 - This displays a dialog box for inputting the search keyword.
- (3) Enter the data you want to find and then tap [OK].
 - This causes the cursor to appear in front of the data you specified (“A” in this example).
- (4) Tap [Edit], [Search], and then [Search Next]. Or, tap  to scroll the toolbar and tap .
 - This causes the cursor to appear in front of the next instance of the data you specified (“A” in this example).
- (5) Repeat step (4) as many times as you want.

Tip

- The message “Not Found” appears if the keyword you specify does not exist in the program.
- The keyword you specify for [New Search] remains in effect until you close the Program Editor window. Executing the [Search Next] command when there is no keyword specified by [New Search] causes the error message “No word is specified” to appear.





12-4 Managing Files

Renaming a File

Use the following procedure when you want to change the name of a file.

• ClassPad Operation

- (1) Tap  to display the Variable Manager.
 - This displays a list of folders.
 - You may need to tap the  icon and scroll the toolbar to see the  icon.
- (2) Tap the name of the folder that contains the file you want to rename.
 - This displays all of the files/variables in the folder.
- (3) Tap the name of the file you want to rename.
- (4) Tap [Edit] and then [Rename].
 - This displays a dialog box for inputting a file name.
- (5) Enter the new file name and then tap [OK].
- (6) Tap [Close] twice to close the Variable Manager.

Tip

- See “1-8 Using the Variable Manager”.

Deleting a Program

The following procedure deletes a program file name, which also deletes the program.

• ClassPad Operation

- (1) Tap  to display the Variable Manager.
 - This displays a list of folders.
- (2) Tap the name of the folder that contains the file you want to delete.
 - This displays all of the files/variables in the folder.
- (3) Select the check box next to the file you want to delete.
 - You can select one file or multiple files for deletion.
- (4) Tap [Edit] and then [Delete].
- (5) On the confirmation dialog box that appears, tap [OK] to delete the selected file, or [Cancel] to cancel the operation without deleting anything.
- (6) Tap [Close] twice to close the Variable Manager.

Tip

- Be sure to close a file before you try to rename or delete it. Trying to rename or delete an open file will cause an error.
- See “1-8 Using the Variable Manager”.



Changing the File Type

You can use the following procedures to change the file type.

- **To change a program file to a text file**

While a program file is open, tap [Edit], [Mode Change], and then [▶Text].

- **To change a text file to a program file**

While a text file is open, tap [Edit], [Mode Change], and then [▶Normal].

Tip

- Note that the above operations are not possible while a user-defined function is open.

- **To change an editable file to an edit prohibited program file**

(1) Open the program file you want to make edit prohibited.

(2) Tap [Edit] and then [Compress].

- This displays a dialog box for inputting the backup file name. The backup file is a copy of the original (editable) file, which you can keep on hand if you have trouble changing an edit prohibited program file back to an editable file.

(3) Enter the backup file name and then tap [OK].

- This saves two copies of the file. One is an edit prohibited program file under the name of the original (editable) file. The other is an editable backup file, which is created under the name you specify in step (3), above.

Original File (editable):	sample
Specified File Name:	sample2
Resulting Files:	sample (non-editable) sample2 (editable)

- An edit prohibited program file cannot be opened from the Program Editor window.
- Edit prohibited program files are displayed in the Variable Manager as “EXE” type files.
- Tapping [Cancel] instead of [OK] in step (3) quits the procedure without changing the file type.



12-5 User-defined Functions

ClassPad lets you configure calculation operations as user-defined functions, which can then be used inside of numeric expressions just like its built-in functions. User-defined functions can also be called up in other applications.

- The Program Editor window is used for creating user-defined functions.
- User-defined functions are stored in ClassPad memory as “Function” type variables. Naming, storage, and folder rules are identical to those for user variables.

Creating a New User-defined Function

This procedure is identical to that for storing a program.

- Anything you enter on the Program Editor window is stored as a user variable.

Example

- Function Name: f4
- Expression: $x \times (x + 1) \times (x - 2)$

• ClassPad Operation

- (1) On the application menu, tap  .
- (2) Tap  , or tap [Edit] and then [New File].
- (3) On the screen that appears, configure the settings described below.

For this setting:	Do this:
Type	Tap the down arrow button and then select “Function”.
Folder	Tap the [Folder] down arrow button and then select the name of the folder where you want to save the user-defined function.
Name	Enter up to eight bytes for the user-defined function name.

- (4) After everything is the way you want, tap [OK].
- (5) Input the expression you want.



- Input user-defined function arguments as parameter variables. For more information about parameter variables, see page “Configuring Parameter Variables and Inputting Their Values” on page 12-2-7.

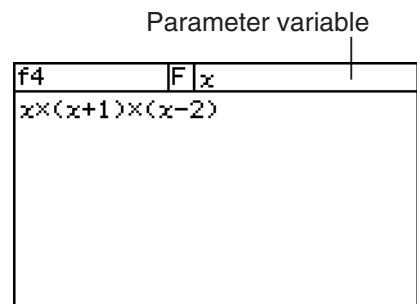

(6) After the function is the way you want, tap $\boxed{\text{F}}$, or tap [Edit] and then [Save File] to save it.

Tip

- A user-defined function can contain only a single mathematical expression. An error “Invalid in a Function or Current Expression” occurs if a user-defined function contains multiple expressions, or is followed by a carriage return.
- A user-defined function cannot contain any command.

■ Creating a User-defined Function Using the Define Command

The procedure below describes how to create a user-defined function by executing the **Define** command from the Main application.

Syntax: Define \square [`<folder name>`] `<function name>` (`[<variable name>`, `<variable name>`...])
= `<expression>`

- Items inside of brackets ([]) can be skipped.
- \square indicates a space.

• ClassPad Operation

- (1) On the application menu, tap .
- (2) Press $\boxed{\text{Keyboard}}$, and then tap the $\boxed{\text{cat}}$ (catalog) tab.
- (3) On the catalog (cat) keyboard that appears, tap the [Form] down arrow button, and then select [Cmd].
- (4) Scroll the list of commands until the **Define** command is visible, and then tap **Define** to select it.
- (5) Tap [INPUT] to input the **Define** command.
- (6) Input the function you want to define.

Example 1: Define folder1 \ f1(x) = 2x + 1 (where folder1 is an existing folder)

Example 2: Define f2(x, y) = 2x + 3y + 1

Example 3: Define sen(x) = sin (x)
- (7) Tap $\boxed{\text{EXE}}$ to store the function.

Tip

- You can include up to 99 arguments in a function.
- If you do not specify a folder, the function is stored in the current folder.
- A function defined using the **Define** command can contain only a single expression. You cannot link multiple expressions or commands using colons (:) or carriage returns.

Executing a User-defined Function

The following is the syntax for executing a user-defined function.

<function name> ([<argument>[,<argument>...]])

The following shows an example of how to perform a manual calculation in the Main application.

Example: The following is a function created under “Creating a New User-defined Function” on page 12-5-1.

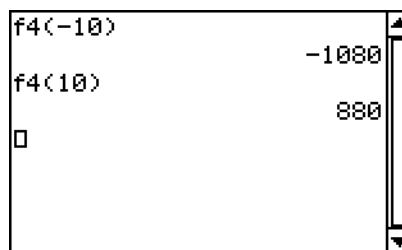

$$f4(x) = x \times (x + 1) \times (x - 2)$$



A screenshot of a calculator interface showing the execution of a user-defined function. The input is 'f4(-10)' and the output is '-1080'. Below that, the input is 'f4(10)' and the output is '880'. There is a small square icon below the second output. The interface has a scroll bar on the right side.

f4(-10)	-1080
f4(10)	880

Tip

- You can use the following steps to recall user-defined functions stored in the “library” folder using the catalog (cat) keyboard. For more information about the “library” folder, see “1-7 Variables and Folders”.
1. Press .
 2. Tap the  (catalog) tab.
 3. On the catalog (cat) keyboard, tap the [Form] down arrow button, and then select [USER].
 4. Scroll the list of functions until the function you want is visible, and then tap the function name you want.
 5. Tap [INPUT].



Editing a User-defined Function

To edit an existing user-defined function, use the same procedures as those described under “Modifying an Existing Program to Create a New One” on page 12-3-2. Editing procedures are the same, regardless of whether you originally created the function using the **Define** command or Program Editor.

Deleting a User-defined Function

To delete an existing user-defined function, use the same procedure as the one described under “Deleting a Program” on page 12-4-1. The delete procedure is the same, regardless of whether you originally created the function using the **Define** command or Program Editor.



12-6 Program Command Reference

Using This Reference

The following table shows the conventions that are used in the descriptions of this section.

If you see something like this:	It means this:
A boldface word, like Input	The boldface word is a command.
□	This indicates a space. Always make sure you input one space between a command and its parameters. Example: GetKey□<variable name>
{ }	You need to select one of the multiple options enclosed inside the braces ({ }). When inputting the command, do not include the braces.
[]	Anything inside brackets ([]) is optional. You can input the item inside the brackets or omit it. When inputting the command, do not include the brackets.
...	The term to the left of ellipsis (...) can be input more than once or repeated.
10	This is a constant.
10 + 20	This is an arithmetic expression.
A	This is a variable.
"AB"	This is a character string.
<string>	You should input what is described inside the angle brackets (< >). When inputting the command, do not include the angle brackets.

Tip

- In addition to program commands, this section also includes descriptions of the following functions.
 - pxlTest(
 - plotTest(
 - strToExp(



Program Application Commands

■ Program Notation

(Carriage Return)

Function: Performs a carriage return operation.

Description

In Program Editor, tap the  button to input a carriage return.

- The carriage return can be used in a user program. It cannot, however, be used in a manual calculation performed in the Main application.

' (Comment)

Function: Any text following this symbol is not executed. You can use this command to include comment text in your program.

Description

Any line that starts with the comment symbol (') is treated as comment text, which is skipped during program execution.

: (Multi-statement Command)

Function: Use this command to link a series of statements into a multi-statement (on a single line).

Description

The multi-statement command can be used in a user program. It cannot, however, be used in a manual calculation performed in the Main application.



Input

GetKey

Syntax: GetKey □ <variable name>

Function: This command assigns the code number of the last key pressed to the specified variable.

Description

- This command assigns the code number of the last key pressed to the specified variable. The following shows a list of available code numbers.

Key	Code	Key	Code
0	48	(40
1	49)	41
2	50	?	44
3	51	(-)	45
4	52	x	60856
5	53	y	60857
6	54	z	60858
7	55	^	94
8	56	EXE	13
9	57	▲	28
.	46	▼	29
EXP	147	◀	30
+	43	▶	31
-	45	Keyboard	144
×	60944	← (Back Space)	8
÷	47	ON/OFF	145
=	61	Clear	12

- 0 is assigned to the variable if no key was pressed.

GetPen

Syntax: GetPen <variable name 1>, <variable name 2>

Function: This command assigns the coordinates of the point tapped on the screen to a specified variable.

Description

This command assigns the x -coordinate (horizontal axis) to <variable 1> and the y -coordinate (vertical axis) to <variable 2>. The coordinates at the point in the upper left corner of the screen are (1, 1), and coordinate values are specified in the range of 1 to 160 for the x -coordinate and 1 to 240 for the y -coordinate.

Input

Syntax: Input <variable name>[, "<string 1>"][, "<string 2>"]]

Function: When program execution reaches the **Input** command, the user is prompted for input of a value, which is assigned to the specified variable.

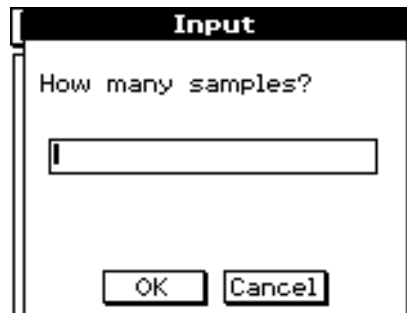

Description

- If you do not specify anything for "<string 1>", the prompt "<variable name>?" appears by default.
- The text specified for "<string 2>" is used as the input dialog box title.
- The **Input** command pauses program execution and displays a dialog box that contains the text string indicated by "<string 1>" and an input box. A text string enclosed within quotation marks (" ") or a variable name can be specified for "<string 1>".
- Specifying a long text string can cause part of it to be cut off when it is displayed in the dialog box.
- When the dialog box appears, input a value into the input box and then tap [OK]. This closes the dialog box, assigns the input value to the applicable variable and resumes program execution.
- Tapping [Cancel] on the dialog box terminates program execution.
- During execution of the **Input** command, program execution is paused for input of data. While a program is paused, you can input individual mathematical expressions only. You cannot input commands or multiple expressions joined by colons (:).

InputFunc

Syntax: InputFunc \square <user-defined function name> (<argument>[,<argument>...])
[, "<string 1>"[, "<string 2>"]]

Function: When program execution reaches the **InputFunc** command, the user is prompted to input the contents of the user-defined function.

Example: InputFunc v(v0, t), "To define function v0(m/s), t(sec)", "define function"

Description

- If you do not specify anything for "<string 1>", the prompt "<variable name>?" appears by default.
- The text specified for "<string 2>" is used as the input dialog box title.
- The **InputFunc** command pauses program execution and displays a dialog box that contains the text string indicated by "<string 1>" and an input box. The dialog box that appears is identical to the **Input** command dialog box. A text string enclosed within quotation marks (" ") or a variable name can be specified for "<string 1>".
- Specifying a very long display text string can cause part of it to be cut off when it is displayed in the dialog box.
- When the dialog box appears, input an expression into the input box and then tap [OK]. This closes the dialog box, assigns the input expression to the applicable variable and resumes program execution.
- Tapping [Cancel] on the dialog box terminates program execution.

InputStr

Syntax: InputStr \square <variable name>[, "<string 1>"[, "<string 2>"]]

Function: When program execution reaches the **InputStr** command, the user is prompted for input of a string, which is assigned to a variable.

Description



- The **InputStr** command pauses program execution and displays a dialog box that contains the text string indicated by "<string 1>" and an input box. The dialog box that appears is identical to the **Input** command dialog box. A text string enclosed within quotation marks (" ") or a variable name can be specified for "<string 1>".
- Specifying a long display text string can cause part of it to be cut off when it is displayed in the dialog box.
- When the dialog box appears, input a string into the input box and then tap [OK]. This closes the dialog box, assigns the input string to the applicable variable and resumes program execution.
- Tapping [Cancel] on the dialog box terminates program execution.
- The text specified for "<string 2>" is used as the input dialog box title.
- If you do not specify anything for "<string 1>", the prompt "<variable name>?" appears by default.



■ Output

About the Program Output window

The “Program Output window” shows text displayed by program execution. The term “Program Output window” does not include dialog boxes displayed by **Message** and other commands.

- Only one Program Output window can be stored at a time. Executing the **ClrText** command or using Program Loader to execute a text file clears the currently stored Program Output window.
- The Program Output window can be displayed by tapping  and then [Program Output], or by tapping  on the Program Loader window. The Program Output window also appears whenever the **DispText** command is executed in a program.

ClrText

Syntax: ClrText

Function: This command clears text from the Program Output window.

DispText

Syntax: DispText

Function: This command displays the Program Output window.

Description: You can use this command to re-display the Program Output window following display of the Graph window, Table window, or other window.

Example: To re-display the Program Output window after it has been cleared by a graphing operation or some other operation

```

GraphType "y="
Define y1(x) = sqrt(x)
GTSElOn 1
ViewWindow -7.7, 7.7, 1, -3.8, 3.8, 1
0 => FStart
10 => FEnd
1 => FStep
ClrText ← Initializes the Program Output window.
Print "y1(x) = sqrt(x)" ← Displays the graph expression on the Program Output window.
Print "Tap Continue button." ← Tells user what to do to continue program execution after reading the
message.

Pause ← Pauses program execution to allow user to read Program Output window message.
DrawGraph ← Draws the graph.
DispFTable ← Displays the table.
Pause ← Pauses program execution to allow for graph and table editing. Program Output window is not
displayed at this time.

DispText ← Re-displays the Program Output window.
Pause ← Pauses program execution to allow user to read Program Output window message.

```



Locate

Syntax 1: `Locate` `<x-coordinate>`, `<y-coordinate>`, `<expression>`

Syntax 2: `Locate` `<x-coordinate>`, `<y-coordinate>`, `"<string>"`

Function: This command displays the result of the specified expression or the specified text string at the specified coordinates on the display screen.

Description

- The coordinates of the point at the upper left corner of the effective area of the **Locate** command are (1, 1), and coordinate values can be specified in the range of 1 to 290 for the *x*-coordinate and 1 to 290 for the *y*-coordinate. Note, however, that the actual dot count of the ClassPad screen is 160 × 240.
- An expression result is displayed as a single line.

Message

Syntax: `Message` `"<string 1>"` [`,"<string 2>"`]

Function: This command pauses program execution and displays a dialog box containing the text specified by `"<string 1>"`. The text is positioned flush top left. The text specified for `"<string 2>"` is used as the dialog box title.



Description

- Text strings enclosed within quotation marks (" ") or variable names can be specified for `"<string 1>"` and `"<string 2>"`.
- Tapping [OK] closes the dialog box and resumes program execution.
- Tapping [Cancel] terminates program execution.

Print

Syntax 1: `Print` `<expression>`

Syntax 2: `Print` `"<string>"`

Function: This command displays the result of the specified expression or the specified text string.

Description

An expression result is displayed as a single line. When the result is a long expression, fraction, or string, it may not fit on the display. In such a case, use the **PrintNatural** command instead.

PrintNatural

Syntax: PrintNatural \square <expression>[, "<string>"]

Function: This command pauses program execution and displays the result of the specified expression in natural format.

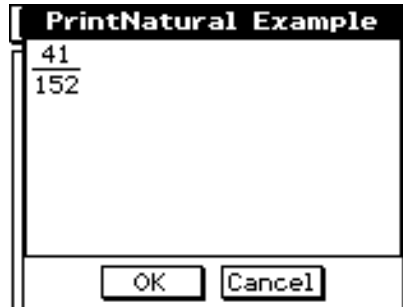

Description

- A text string enclosed within quotation marks (" ") or a variable name can be specified for "<string>".
- Tapping [OK] closes the dialog box and resumes program execution. Tapping [Cancel] terminates program execution.

■ Program Execution

#

Syntax: # <string variable name>

Function: This command specifies a string variable whose string is a variable name.

Example 1: When the content of variable exp1 is π and the content of variable str1 is "exp1", $\sin(\#\text{str1})$ calculates $\sin(\pi)$.

Example 2: To cause a folder to be created during program execution:

InputStr \square name, "Foldername"

NewFolder \square #name

\Rightarrow

Syntax 1: $\left\{ \begin{array}{l} \langle \text{expression} \rangle \\ \langle \text{string} \rangle \end{array} \right\} \Rightarrow \langle \text{variable name} \rangle$

Syntax 2: $\left\{ \begin{array}{l} \langle \text{expression} \rangle \\ \langle \text{string} \rangle \end{array} \right\} \Rightarrow \langle \text{list element} \rangle$

Syntax 3: $\langle \text{expression} \rangle \Rightarrow \langle \text{matrix element} \rangle$

Function: With this command, the content of the expression on the left is evaluated, and the result is assigned to the item on the right.

Break

Syntax: Break

Function: This command terminates a loop and causes execution to advance to the next command following the loop process.

Description

- **Break** terminates a loop and causes execution to advance to the next command following the loop process.
- **Break** can be used inside of a **For**, **Do**, **While**, or **Switch** process.

Define

Syntax: Define □ [<folder name> \]<function name>([<variable name>[,<variable name>...]]) =<expression>

- Items inside of brackets ([]) can be skipped.

Function: Creates a user-defined function.

Description: See page 12-5-2.

Do~LpWhile

Syntax: Do
 [<statement>] ...
 LpWhile □ <expression>

<expression> is a condition that evaluates to true or false.

Function: The specified statements are repeated as long as the condition is true.

Description

- The statements between **Do~LpWhile** are repeated as long as the condition is true. When the condition becomes false, execution jumps to the next command after the **LpWhile** command.
- Since the condition comes after **LpWhile**, the condition is not evaluated until the end of the loop is reached.
- You can use a multi-statement command (:) in place of the carriage return to separate statements.
- It is always a bad idea to use the **Goto** command to exit a **Do~LpWhile** loop. Not only is it poor programming, it can cause problems due to improper termination of internal processes used by the loop operation.



For~To~(Step~)Next

Syntax:

For <expression 1> => <control variable name> To <expression 2> [Step <expression 3>]
 [<statement>] ...

Next

<expression 1> is the initial value, <expression 2> is the end value, and <expression 3> is the step.

Function

Anything between the **For** command and the **Next** command is repeated for a count starting with the initial value of the control variable and ending when the control variable reaches the end value. Each pass causes the value of the control variable to be changed by the value specified by the step value. The loop is terminated whenever the control variable value exceeds the end value.

Description

- 1 is used for the step if a step value is not specified.
- The initial value can be less than the end value, as long as a positive value is specified for the step. In this case, the value of the control value is increased by the step with each pass.
- The initial value can be greater than the end value, as long as a negative value is specified for the step. In this case, the value of the control value is decreased by the step with each pass.
- You can use a multi-statement command (:) in place of the carriage return to separate statements.
- It is always a bad idea to use the **Goto** command to exit a **For~Next** loop. Not only is it poor programming, it can cause problems due to improper termination of internal processes used by the loop operation.

Goto~Lbl

Syntax: Goto <label name>
 Lbl <label name>

Function: This command causes program execution to jump to a specific location.

Description

- <label name> is a text string that is subject to the same rules as variable names.
- **Goto** and **Lbl** are used in pairs. Program execution jumps from **Goto** to the **Lbl** with the same label name. A single **Lbl** can be used as the jump destination of multiple **Goto** commands.
- This command can be used to loop back to the beginning of a program or to jump to any location within the program.
- An error occurs if ClassPad is unable to find a **Lbl** with the same label as **Goto**.
- Note that the # command cannot be used in a label name.



If~Then~Else~IfEnd

Syntax 1: If \square <expression>

```

Then
  [<statement>] ... } Then <block>
IfEnd

```

Function 1

- If the expression is true, the statement in the **Then** block is executed. After that, execution advances to the next statement after **IfEnd**.
- If the expression is false, execution advances to the next statement after **IfEnd**, without executing the statement in the **Then** block.

Syntax 2: If \square <expression>

```

Then
  [<statement>] ... } Then <block>
Else
  [<statement>] ... } Else <block>
IfEnd

```

Function 2

- If the expression is true, the statement in the **Then** block is executed. After that, execution advances to the next statement after **IfEnd**.
- If the expression is false, the statement in the **Else** block is executed instead of the **Then** block. After that, execution advances to the next statement after **IfEnd**.

Syntax 3: If \square <expression>

```

Then
  [<statement>]... } If Then <block>
Elseif  $\square$  <expression>
  Then
    [<statement>] ... } Elseif Then <block>
IfEnd

```

Function 3

- If the expression is true, the statement in the **If Then** block is executed. After that, execution advances to the next statement after **IfEnd**.
- If the **If** command expression is false, the **Elseif** command expression is tested. If it is true, the statement in the **Elseif Then** block is executed. After that, execution advances to the next statement after **IfEnd**. If it is false, execution advances to the next statement after **IfEnd**.



Syntax 4: If □ <expression>

```

Then
[<statement>] ... } If Then <block>
Elseif □ <expression>
Then
[<statement>] ... } Elseif Then <block>
Else
[<statement>] ... } Else <block>
IfEnd

```

Function 4

- If the expression is true, the statement in the **If Then** block is executed. After that, execution advances to the next statement after **IfEnd**.
- If the **If** command expression is false, the **Elseif** command expression is tested. If it is true, the statement in the **Elseif Then** block is executed. After that, execution advances to the next statement after **IfEnd**. If it is false, the **Else** block statement is executed. After that, execution advances to the next statement after **IfEnd**.

Description

- With all four of the syntaxes described above, you can use a multi-statement command (:) in place of the carriage return to separate **Then** block statements.
- The **If~IfEnd** command can be nested.

Example: Input a

Input b

If a < 0

Then

0 ⇒ a

If b < 0

Then

0 ⇒ b

IfEnd

IfEnd

- The **If~IfEnd** loop can be exited using the **Break** command or **Return** command.
- It is always a bad idea to use the **Goto** command to exit an **If~IfEnd** loop. Not only is it poor programming, it can cause problems due to improper termination of internal processes used by **If**.



Pause

Syntax: Pause

Function: This command pauses program execution and displays a pause indicator on the right side of the status bar.

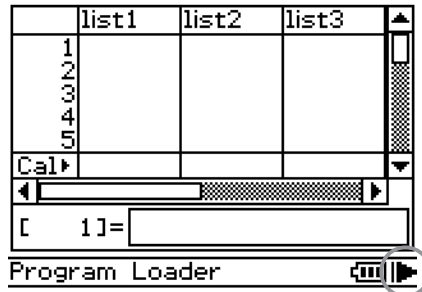

Description

- You can perform manual operations on the ClassPad display screen while program execution is paused by the **Pause** command.
- Program execution remains paused until you tap the  button on the status bar, or until six minutes pass (after which program execution resumes automatically).

Return

Syntax: Return {<variable>}

Function 1 (Main Program)

This command terminates program execution.

Function 2 (Subroutine Program)

This command returns from a subroutine.

Tip

- The **Return** command can be executed during an **If**, **For**, **Do**, **While**, or **Switch** process.
- Appending a <variable> to the **Return** command in the Main application and executing the command will cause the variable to be displayed when the program is complete.

Skip

Syntax: Skip

Function: This command causes execution to jump to the statement at the beginning of a loop.

Description

- **Skip** causes execution to jump to the statement at the beginning of a loop.
- **Skip** can be used inside of a **For**, **Do**, or **While** process.

Stop

Syntax: Stop

Function: This command terminates program execution.

Description: This command terminates all program execution, including that of the main program when a subroutine program is running.

Switch~Case~Default~SwitchEnd

Syntax: Switch□<expression 1>
 Case□<expression 2>
 [<statement>] ...
 Break
 Case□<expression 3> ...
 [<statement>] ...
 Break
 ...
 Case□<expression n>
 [<statement>] ...
 Break
 [Default]
 [<statement>] ...
 SwitchEnd

<expression 1> through <expression n> should be expressions that produce real numbers.

Function: This command executes one of a series of processes based on the value of <expression>.

Description

- This command executes the statement following the **Case** expression that matches the **Switch** expression.
- If there is no matching **Case** expression, the statement following **Default** is executed. If there is no **Default** specified, a non-match jumps to the statement following **SwitchEnd**.
- You can use a multi-statement command (:) in place of the carriage return to separate statements.
- **Switch~SwitchEnd** can be exited using the **Break** command, **Return** command, or **Goto** command.

Wait

Syntax: Wait□[<expression>]

Function: This command pauses program execution, and then restarts it after the number of seconds specified by the expression passes.

Description

- If you do not specify any expression, program execution is paused until you tap the screen, or press a key.
- The maximum valid specification for <expression> is 360 seconds (six minutes). Specifying a value greater than 360 causes program execution to resume after 360 seconds, regardless of the specified value.
- The ClassPad's Auto Power Off function is disabled during a pause caused by the **Wait** command.
- If the Auto Power Off trigger time is reached during the pause, program execution resumes.



While~WhileEnd

Syntax: While \square <expression>
 [<statement>] ...
 WhileEnd

<expression> is a condition that evaluates to true or false.

Function: The specified statements are repeated as long as the condition is true.

Description

- The statements between **While~WhileEnd** are repeated as long as the condition is true. When the condition becomes false, execution jumps to the next command after the **WhileEnd** command.
- Since the condition comes after **While**, the condition is evaluated before the loop is started.
- You can use a multi-statement command (:) in place of the carriage return to separate statements.
- It is always a bad idea to use the **Goto** command to exit a **While~WhileEnd** loop. Not only is it poor programming, it can cause problems due to improper termination of internal processes used by the loop operation.

Application Command List

The commands listed in this section can also be used in other ClassPad applications. You can select these commands by selecting "All" for the [Form] setting on the catalog (cat) soft keyboard. Or, you can simply type the command. Also, many of these commands appear as menu items within the [Ctrl], [I/O] or [Misc] menus.

■ Graph & Table**Circle**

Syntax: Circle \square <center x-coordinate>, <center y-coordinate>, radius

Function: Draws a circle.

Example: Circle -1, -1, 2

ClearSheet

Syntax: ClearSheet \square $\left[\begin{array}{l} \{ <sheet number> \} \\ \{ "<sheet name>" \} \end{array} \right]$

Function: Deletes the sheet name and expressions on the sheet, and returns its settings to their default values. Omitting the argument causes all sheets to be cleared.



ClrGraph**Syntax:** ClrGraph**Function:** Clears the Graph window and returns View Window parameters to their initial default settings.**Cls****Syntax:** Cls**Function:** Clears sketch elements (lines and other figures sketched on the Graph window), and graphs drawn using drag and drop.**DispFTable****Syntax:** DispFTable**Function:** Creates and displays a function table.**DispSmryTbl****Syntax:** DispSmryTbl**Function:** Creates and displays a summary table.**Distance****Syntax:** Distance \square <x-coordinate 1>, <y-coordinate 1>, <x-coordinate 2>, <y-coordinate 2>**Function:** Determines the distance between two points.**Description:** Executing this command makes the Graph window active, displays pointers at the locations of coordinates 1 and 2, and displays the distance between the pointers.**Tip**

- An error occur if <x-coordinate> or <y-coordinate> is outside of the current Graph window.

DrawFTGCon, DrawFTGPlot**Syntax:** DrawFTGCon
DrawFTGPlot**Function:** Graphs a function using a generated number table, in accordance with the conditions of each command.**Description:** FTG stands for “Function Table Graph”. **DrawFTGCon** draws a connect type graph, while **DrawFTGPlot** draws a plot type graph.

DrawGraph

Syntax: DrawGraph□[<expression>]

Function: Graphs the selected expression or an expression specified as a parameter.

Description: <expression> has a $y=$ type expression on the right side. Graphing of any other type of expression is not supported by this command.

Example: DrawGraph: Graphs the currently selected expressions.
DrawGraph $\sin(x)$: Graphs $y = \sin(x)$.

DrawShade

Syntax: DrawShade□<expression 1>, <expression 2>[, <number 1>, <number 2>]

Function: Shades the area between expression 1 (lower curve) and expression 2 (upper curve) from x -values of number 1 to number 2.

Description: Expression 1 and expression 2 have a $y=$ type expression on the right side. Graphing of any other type of expression is not supported by this command.

Example: DrawShade: Shades the area above the first expression and below the second expression from -2 to 2 .
DrawShade $x - 4, x^2, -2, 2$

GraphType

Syntax: GraphType□ $\left\{ \begin{array}{l} "y=" \\ "r=" \\ "xt=" \\ "x=" \\ "y>" \\ "y<" \\ "y\geq" \\ "y\leq" \\ "x>" \\ "x<" \\ "x\geq" \\ "x\leq" \end{array} \right\}$

Function: Specifies the graph expression input type.

Example: GraphType "r ="

GTSelOff

Syntax: GTSelOff□<graph number>

Function: Deselects a graph expression.

Description: Graph number range: 1 to 100



GTSELon**Syntax:** GTSELon \square <graph number>**Function:** Selects a graph expression.**Description:** Graph number range: 1 to 100**Horizontal****Syntax:** Horizontal \square <y-coordinate>**Function:** Draws a horizontal line.**Inverse****Syntax:** Inverse \square <y or x graph number>**Function:** Graphs the inverse of a function.**Description:** Graph number range: 1 to 100**Line****Syntax:** Line \square <start point x-coordinate>, <start point y-coordinate>, <end point x-coordinate>, <end point y-coordinate>**Function:** Draws a line between two specified coordinates.**Example:** Line 1, -2, 2, 3**Tip**

- The line is not drawn if a start point coordinate or end point coordinate is outside of the current Graph window.

NormalLine**Syntax:** NormalLine \square <graph number>, <x-coordinate>**Function:** Draws a normal line.**Example:** NormalLine 1, 2**Description:** Draws a line normal to the graph at the specified x -value.**Plot****Syntax:** Plot \square <x-coordinate>, <y-coordinate>**Function:** Displays a pointer at the location specified by the coordinates and plots a point there.**PlotChg****Syntax:** PlotChg \square <x-coordinate>, <y-coordinate>**Function:** Toggles display of the plot at the specified coordinates on and off.

PlotOff

Syntax: PlotOff \square <x-coordinate>, <y-coordinate>

Function: Turns off display of the plot at the specified coordinates.

PlotOn

Syntax: PlotOn \square <x-coordinate>, <y-coordinate>

Function: Turns on display of the plot at the specified coordinates.

plotTest(

Syntax: plotTest(<x-coordinate>, <y-coordinate>)

Function: Returns 1 when the dot at the specified coordinates is on, and 0 when it is off.

Example: plotTest(2,-3) \Rightarrow a. Result is placed in a.

Description: Only dots within the screen are valid.

PTBrokenThck

Syntax: PTBrokenThck \square <graph number>

Function: Specifies “Broken Thick” (•••) as the graph line type.

Description: Graph number range: 1 to 100

PTCross

Syntax: PTCross \square <graph number>

Function: Specifies “Cross Plot” (⌘) as the graph line type.

Description: Graph number range: 1 to 100

PTDot

Syntax: PTDot \square <graph number>

Function: Specifies “Dot Plot” (••••) as the graph line type.

Description: Graph number range: 1 to 100

PTNormal

Syntax: PTNormal \square <graph number>

Function: Specifies “Normal” (—) as the graph line type.

Description: Graph number range: 1 to 100

PTSquare

Syntax: PTSquare \square <graph number>

Function: Specifies “Square Plot” (■) as the graph line type.

Description: Graph number range: 1 to 100



PTThick

Syntax: PTThick <graph number>

Function: Specifies “Thick” (—) as the graph line type.

Description: Graph number range: 1 to 100

PxlChg

Syntax: PxlChg <x-dot>, <y-dot>

Function: Toggles display of the specified pixel on and off.

Example: PxlChg 5,1

PxlOff

Syntax: PxlOff <x-dot>, <y-dot>

Function: Turns off display of the specified pixel.

Example: PxlOff 3, 3

PxlOn

Syntax: PxlOn <x-dot>, <y-dot>

Function: Turns on display of the specified pixel.

Example: PxlOn 63, 31

pxlTest(

Syntax: pxlTest(<x-dot>, <y-dot>)

Function: Returns 1 when the specified pixel is on, and 0 when it is off.

RclGMem

Syntax: RclGMem <variable name>

Function: Recalls GMem data (graph expression and related information), which was previously saved under the specified name.

Example: RclGMem AZ

RclPict

Syntax: RclPict <picture name>

Function: Recalls a Pict image, which was previously saved under the specified name.

Example: RclPict PIC1



StoPict**Syntax:** StoPict□<picture name>**Function:** Assigns a name to a Pict image and stores it.**Example:** StoPict Pict1**StoVWin****Syntax:** StoVWin□<variable name>**Function:** Assigns a name to View Window values and stores them.**Example:** StoVWin VWIN1**TangentLine****Syntax:** TangentLine□<graph number>, < x -coordinate>**Function:** Draws a line tangent to the graph at the specified x -value.**Example:** TangentLine 1, 1**Text****Syntax:** Text□<horizontal pixel value>, <vertical pixel value>, $\left. \begin{array}{l} \langle \text{numeric value} \rangle \\ \langle \text{string} \rangle \\ \langle \text{variable} \rangle \end{array} \right\}$ **Function:** Displays the specified text on the Graph window.**Example:** Text 8, 2, "Graph"**Vertical****Syntax:** Vertical□< x -coordinate>**Function:** Draws a vertical line passing through the x -coordinate value.

ViewWindow

Syntax 1: ViewWindow \square $\left[\text{LogP} \square \left\{ \begin{array}{c} x \\ y \\ xy \end{array} \right\}, \right]$ [xmin value], [xmax value], [xscale value],
 [ymin value], [ymax value], [yscale value], [t θ min value], [t θ max value],
 [t θ step value]

Syntax 2: ViewWindow CallUndef

Syntax 3: ViewWindow

Function:

Syntax 1: Specifies View Window values.

Syntax 2: Makes all View Window values "Undefined".

Syntax 3: Initializes View Window settings.

Description:

- **LogP** specifies logarithmic settings for the x -coordinate and y -coordinate.
- **LogP** and **CallUndef** are reserved words.
- Skipping values after xmin causes values previously set for each item to be used.

Example: ViewWindow , , 0.065, -0.2, 1.016, 0.01, 0.16

ZAuto

Syntax: ZAuto

Function: Performs Auto Zoom.

ZFactor

Syntax: ZFactor \square <xfactor value>, <yfactor value>

Function: Specifies the Factor Zoom Factor value.



■ 3D

ClearSheet3D

Syntax: ClearSheet3D □ $\left[\begin{array}{l} \{ <sheet\ number> \} \\ \{ "<sheet\ name>" \} \end{array} \right]$

Function: Deletes the sheet name and expressions on the sheet, and returns its settings to their default values. Omitting the argument causes all sheets to be cleared.

Draw3D

Syntax: Draw3D

Function: Draws a 3D graph using current settings.

SelOn3D

Syntax: SelOn3D □ <graph number>

Function: Selects a 3D graph function. Also makes the graph sheet that contains the graph function active, and turns off graphing of all the other functions on the sheet.

SheetActive3D

Syntax: SheetActive3D □ $\left\{ \begin{array}{l} <sheet\ number> \\ "<sheet\ name>" \end{array} \right\}$

Function: Activates the specified 3D graph sheet.

SheetName3D

Syntax: SheetName3D □ "<string>", <sheet number>

Function: Assigns a name to a 3D graph sheet.

ViewWindow3D

Syntax 1: ViewWindow3D □ xmin value, xmax value, xgrid value, ymin value, ymax value, ygrid value, zmin value, zmax value, angle θ , angle ϕ

Syntax 2: ViewWindow3D

Function

Syntax 1: Configures 3D graph View Window settings.

Syntax 2: Initializes 3D graph View Window settings.

Description: Skipping any value and inputting a comma only causes the previous setting for that value to be used. Inputting values part way and then skipping input of remaining values causes the previous settings for the remaining values to be used.



■ Conics

DrawConics

Syntax: DrawConics

Function: Draws a conics graph based on the data registered on the Conics Editor window.

■ Sequence

DispDfrTbl

Syntax: DispDfrTbl

Function: Creates and displays an arithmetic sequence table.

DispDQTbl

Syntax: DispDQTbl

Function: Creates and displays a progression of difference table.

DispFibTbl

Syntax: DispFibTbl

Function: Creates and displays a Fibonacci sequence table.

DispQutTbl

Syntax: DispQutTbl

Function: Creates and displays a geometric sequence table.

DispSeqTbl

Syntax: DispSeqTbl

Function: Creates and displays a recursion table.



DrawSeqCon, DrawSeqPlt

Syntax: DrawSeqCon
DrawSeqPlt

Function: Graphs a recursion expression whose vertical axis is a_n (b_n or c_n) and whose horizontal axis is n using a generated number table, in accordance with the conditions of each command.

Description: **DrawSeqCon** draws a connect type graph, while **DrawSeqPlt** draws a plot type graph.

DrawSeqEtrCon, DrawSeqEtrPlt

Syntax: DrawSeqEtrCon
DrawSeqEtrPlt

Function: Graphs a recursion expression whose vertical axis is Σa_n (Σb_n or Σc_n) and whose horizontal axis is n using a generated number table, in accordance with the conditions of each command.

Description: **DrawSeqEtrCon** draws a connect type graph, while **DrawSeqEtrPlt** draws a plot type graph.

SeqSelOff

Syntax: SeqSelOff $\left[\begin{array}{c} a_{n+1} \\ a_{n+2} \\ b_{n+1} \\ b_{n+2} \\ c_{n+1} \\ c_{n+2} \\ a_n E \\ b_n E \\ c_n E \end{array} \right]$

Function: Deselects the specified sequence expression. Specifying " $a_n E$ ", " $b_n E$ ", or " $c_n E$ " as the argument activates [Explicit]. Specifying any other argument activates [Recursive].



SeqSelOn

Syntax: SeqSelOn $\square \left\{ \begin{array}{l} a_{n+1} \\ a_{n+2} \\ b_{n+1} \\ b_{n+2} \\ c_{n+1} \\ c_{n+2} \\ a_n E \\ b_n E \\ c_n E \end{array} \right\}$

Function: Selects the specified sequence expression. Specifying “ $a_n E$ ”, “ $b_n E$ ”, or “ $c_n E$ ” as the argument activates [Explicit]. Specifying any other argument activates [Recursive].

SeqType

Syntax: SeqType $\square \left\{ \begin{array}{l} "n" \\ "a_{n+1}a_0" \\ "a_{n+1}a_1" \\ "a_{n+2}a_0" \\ "a_{n+2}a_1" \end{array} \right\}$

Function: Specifies the recursion type.

Description: Specifying “ n ” as the argument activates [Explicit]. Specifying any other argument activates [Recursive].

Statistics**abExpReg**

Syntax: abExpReg $\square xList, yList[, [FreqList (or 1)][, [<yn>][, \left\{ \begin{array}{l} \text{On} \\ \text{Off} \end{array} \right\}]]]$

Function: Performs $y = a \cdot b^x$ regression.

Description

$xList$: Name of list for storing x -axis data

$yList$: Name of list for storing y -axis data

$FreqList$: Name of list for storing frequency of “ $xList$ ” and “ $yList$ ” data

- “ $FreqList$ ” can be omitted. Doing so sets “1” for “ $FreqList$ ”.
- “ yn ” is the Graph Editor name (y_1, y_2, \dots) that is the copy destination of the regression expression. Copy is not performed when “ yn ” is skipped.
- “On/Off” turns **Residual calc** on or off. **Residual calc** is turned off when this setting is skipped.



CubicReg

Syntax: CubicReg \square xList, yList[, [FreqList (or 1)], [<yn>], $\left\{ \begin{array}{l} \text{On} \\ \text{Off} \end{array} \right\}$]]

Function: Performs $y = a \cdot x^3 + b \cdot x^2 + c \cdot x + d$ regression.

Description

xList: Name of list for storing x -axis data

yList: Name of list for storing y -axis data

FreqList: Name of list for storing frequency of “xList” and “yList” data

- “FreqList” can be omitted. Doing so sets “1” for “FreqList”.
- “yn” is the Graph Editor name (y1, y2, ...) that is the copy destination of the regression expression. Copy is not performed when “yn” is skipped.
- “On/Off” turns **Residual calc** on or off. **Residual calc** is turned off when this setting is skipped.

DefaultListEditor

Syntax: DefaultListEditor

Function: Initializes the sort sequence and display contents of the list on the Stat Editor window (list1 to list6).

DispListEditor

Syntax: DispListEditor

Function: Displays the Stat Editor window.

DispStat

Syntax: DispStat

Function: Displays previous statistical calculation results.

DrawStat

Syntax: DrawStat

Function: Draws a statistical graph.

ExpReg

Syntax: ExpReg \square xList, yList[, [FreqList (or 1)], [<yn>], $\left\{ \begin{array}{l} \text{On} \\ \text{Off} \end{array} \right\}$]]

Function: Performs $y = a \cdot e^{b \cdot x}$ regression.

Description

xList: Name of list for storing x -axis data

yList: Name of list for storing y -axis data

FreqList: Name of list for storing frequency of “xList” and “yList” data

- “FreqList” can be omitted. Doing so sets “1” for “FreqList”.
- “yn” is the Graph Editor name (y1, y2, ...) that is the copy destination of the regression expression. Copy is not performed when “yn” is skipped.
- “On/Off” turns **Residual calc** on or off. **Residual calc** is turned off when this setting is skipped.



LinearReg

Syntax: LinearReg \square xList, yList[, [FreqList (or 1)], [*yn*][, {On/Off}]]

Function: Performs $y = a \cdot x + b$ regression.

Description

xList: Name of list for storing x -axis data

yList: Name of list for storing y -axis data

FreqList: Name of list for storing frequency of “xList” and “yList” data

- “FreqList” can be omitted. Doing so sets “1” for “FreqList”.
- “*yn*” is the Graph Editor name (y_1, y_2, \dots) that is the copy destination of the regression expression. Copy is not performed when “*yn*” is skipped.
- “On/Off” turns **Residual calc** on or off. **Residual calc** is turned off when this setting is skipped.

LogisticReg

Syntax: LogisticReg \square xList, yList[, [*yn*][, {On/Off}]]

Function: Performs $y = c / (1 + a \cdot e^{-b \cdot x})$ regression.

Description

xList: Name of list for storing x -axis data

yList: Name of list for storing y -axis data

- “*yn*” is the Graph Editor name (y_1, y_2, \dots) that is the copy destination of the regression expression. Copy is not performed when “*yn*” is skipped.
- “On/Off” turns **Residual calc** on or off. **Residual calc** is turned off when this setting is skipped.

LogReg

Syntax: LogReg \square xList, yList[, [FreqList (or 1)], [*yn*][, {On/Off}]]

Function: Performs $y = a + b \cdot \ln(x)$ regression.

Description

xList: Name of list for storing x -axis data

yList: Name of list for storing y -axis data

FreqList: Name of list for storing frequency of “xList” and “yList” data

- “FreqList” can be omitted. Doing so sets “1” for “FreqList”.
- “*yn*” is the Graph Editor name (y_1, y_2, \dots) that is the copy destination of the regression expression. Copy is not performed when “*yn*” is skipped.
- “On/Off” turns **Residual calc** on or off. **Residual calc** is turned off when this setting is skipped.

MedMedLine

Syntax: MedMedLine \square xList, yList[, [FreqList (or 1)], [*yn*][, {On/Off}]]

Function: Performs $y = a \cdot x + b$ Med-Med calculation.

Description

xList: Name of list for storing x -axis data

yList: Name of list for storing y -axis data

FreqList: Name of list for storing frequency of “xList” and “yList” data

- “FreqList” can be omitted. Doing so sets “1” for “FreqList”.
- “*yn*” is the Graph Editor name (y_1, y_2, \dots) that is the copy destination of the regression expression. Copy is not performed when “*yn*” is skipped.
- “On/Off” turns **Residual calc** on or off. **Residual calc** is turned off when this setting is skipped.



MultiSortA

Syntax 1: MultiSortA \square <list name>

Syntax 2: MultiSortA \square <base list name>, <subordinate list name>, <subordinate list name>, ...

Function: Sorts a statistical list in ascending order.

Description

- Syntax 1 performs a simple list sort.
- Syntax 2 sorts multiple lists on the base list. Up to five subordinate lists can be specified.

MultiSortD

Syntax 1: MultiSortD \square <list name>

Syntax 2: MultiSortD \square <base list name>, <subordinate list name>, <subordinate list name>, ...

Function: Sorts a statistical list in descending order.

Description

- Syntax 1 performs a simple list sort.
- Syntax 2 sorts multiple lists on the base list. Up to five subordinate lists can be specified.

OneVariable

Syntax: OneVariable \square x List [, FreqList (or 1)]

Function: Single variable statistics calculation

Description

x List: Name of list for storing x -axis data

FreqList: Name of list for storing frequency of “ x List” data

- “FreqList” can be omitted. Doing so sets “1” for “FreqList”.

PowerReg

Syntax: PowerReg \square x List, y List[, [FreqList (or 1)][, [< yn >][, {On/Off}]]]

Function: Performs $y = a \cdot x^b$ regression.

Description

x List: Name of list for storing x -axis data

y List: Name of list for storing y -axis data

FreqList: Name of list for storing frequency of “ x List” and “ y List” data

- “FreqList” can be omitted. Doing so sets “1” for “FreqList”.
- “ yn ” is the Graph Editor name (y_1 , y_2 , ...) that is the copy destination of the regression expression. Copy is not performed when “ yn ” is skipped.
- “On/Off” turns **Residual calc** on or off. **Residual calc** is turned off when this setting is skipped.



QuadReg

Syntax: QuadReg \square xList, yList[, [FreqList (or 1)], [$\langle yn \rangle$], {On/Off}]]

Function: Performs $y = a \cdot x^2 + b \cdot x + c$ regression.

Description

xList: Name of list for storing x -axis data

yList: Name of list for storing y -axis data

FreqList: Name of list for storing frequency of “xList” and “yList” data

- “FreqList” can be omitted. Doing so sets “1” for “FreqList”.
- “ yn ” is the Graph Editor name (y_1, y_2, \dots) that is the copy destination of the regression expression. Copy is not performed when “ yn ” is skipped.
- “On/Off” turns **Residual calc** on or off. **Residual calc** is turned off when this setting is skipped.

QuartReg

Syntax: QuartReg \square xList, yList[, [FreqList (or 1)], [$\langle yn \rangle$], {On/Off}]]

Function: Performs $y = a \cdot x^4 + b \cdot x^3 + c \cdot x^2 + d \cdot x + e$ regression.

Description

xList: Name of list for storing x -axis data

yList: Name of list for storing y -axis data

FreqList: Name of list for storing frequency of “xList” and “yList” data

- “FreqList” can be omitted. Doing so sets “1” for “FreqList”.
- “ yn ” is the Graph Editor name (y_1, y_2, \dots) that is the copy destination of the regression expression. Copy is not performed when “ yn ” is skipped.
- “On/Off” turns **Residual calc** on or off. **Residual calc** is turned off when this setting is skipped.

SinReg

Syntax: SinReg \square xList, yList[, [$\langle yn \rangle$], {On/Off}]]

Function: Performs $y = a \cdot \sin(b \cdot x + c) + d$ regression.

Description

xList: Name of list for storing x -axis data

yList: Name of list for storing y -axis data

- “ yn ” is the Graph Editor name (y_1, y_2, \dots) that is the copy destination of the regression expression. Copy is not performed when “ yn ” is skipped.
- “On/Off” turns **Residual calc** on or off. **Residual calc** is turned off when this setting is skipped.



StatGraph

Syntax 1: StatGraph \square <StatGraph number 1 to 9>, $\left\{ \begin{array}{l} \text{On} \\ \text{Off} \end{array} \right\}$, Graph Type 1, *xList*, *yList*, *FreqList* (or 1), Plot Type

Syntax 2: StatGraph \square <StatGraph number 1 to 9>, $\left\{ \begin{array}{l} \text{On} \\ \text{Off} \end{array} \right\}$, Graph Type 2, *xList*, *yList*, *FreqList* (or 1)

Syntax 3: StatGraph \square <StatGraph number 1 to 9>, $\left\{ \begin{array}{l} \text{On} \\ \text{Off} \end{array} \right\}$, Graph Type 3, *xList*, *yList*

Syntax 4: StatGraph \square <StatGraph number 1 to 9>, $\left\{ \begin{array}{l} \text{On} \\ \text{Off} \end{array} \right\}$, Graph Type 4, *xList*, *FreqList* (or 1)

Syntax 5: StatGraph \square <StatGraph number 1 to 9>, $\left\{ \begin{array}{l} \text{On} \\ \text{Off} \end{array} \right\}$, Graph Type 5, *xList*, Plot Type

Function: Configures statistical graph settings.

Description

xList: Name of list for storing *x*-axis data

yList: Name of list for storing *y*-axis data

FreqList: Name of list for storing frequency of “*xList*” and “*yList*” data

Graph Type 1: **Scatter/xyLine**

Graph Type 2: **LinearR/MedMed/QuadR/CubicR/QuartR/LogR/ExpR/abExpR/PowerR**

Graph Type 3: **SinR/LogisticR**

Graph Type 4: **Histogram/MedBox/ModBox/NDist/Broken**

Graph Type 5: **NPPlot**

Plot Type: **Square/Cross/Dot/Ldot**

StatGraphSel

Syntax: StatGraphSel \square $\left\{ \begin{array}{l} \text{On} \\ \text{Off} \end{array} \right\} \left\{ \begin{array}{l} \text{"Reg,"} \\ \text{"Graph"} \end{array} \right\}$

Function: Turns statistical graphing on or off.

Description

- **Reg** selects Previous Reg.
- **Graph** selects Graph Function.
- Skipping **Reg** and **Graph** turns StatGraph, Previous Reg, and Graph Function on or off.

TwoVariable

Syntax: TwoVariable \square *xList*, *yList* [, *FreqList* (or 1)]

Function: Paired variable statistics calculation

Description

xList: Name of list for storing *x*-axis data

yList: Name of list for storing *y*-axis data

FreqList: Name of list for storing frequency of “*xList*” and “*yList*” data

- “*FreqList*” can be omitted. Doing so sets “1” for “*FreqList*”.



■ Setup

DefaultSetup

Syntax: DefaultSetup

Function: Initializes all setup data settings.

SetAxes

Syntax: SetAxes $\left\{ \begin{array}{l} \text{On} \\ \text{Number} \\ \text{Off} \end{array} \right\}$

Function: Turns display of Graph window axes on or off.

SetAxes3D

Syntax: SetAxes3D $\left\{ \begin{array}{l} \text{On} \\ \text{Off} \\ \text{Box} \end{array} \right\}$

Function: Turns display of axes on (normal), off, or **Box** (box type coordinate) for 3D graphing. Specifying **Box** displays the draw area in box form.

SetBG

Syntax: SetBG $\left\{ \begin{array}{l} \text{<picture name>} \\ \text{Off} \end{array} \right\}$

Function: Specifies a PICT image for the background. Background image display is turned off when "Off" is specified.

SetCellWidth

Syntax: SetCellWidth $\left\{ \begin{array}{l} 2 \\ 3 \\ 4 \end{array} \right\}$

Function: Specifies the number of rows displayed on the Stat Editor and data table windows.

SetComplex

Syntax: SetComplex

Function: Specifies the Complex mode (to perform complex number calculations).



SetCoord

Syntax: SetCoord $\left\{ \begin{array}{l} \text{On} \\ \text{Off} \end{array} \right\}$

Function: Turns display of Graph window pointer coordinates on or off.

SetCoordOff3D

Syntax: SetCoordOff3D

Function: Turns off display of pointer coordinates for 3D graphing.

SetCoordPol3D

Syntax: SetCoordPol3D

Function: Specifies use of polar coordinates for coordinate display during 3D graphing.

SetCoordRect3D

Syntax: SetCoordRect3D

Function: Specifies use of rectangular coordinates for coordinate display during 3D graphing.

SetDecimal

Syntax: SetDecimal

Function: Specifies the Decimal mode (displays results in decimal format).

SetDegree

Syntax: SetDegree

Function: Specifies "Degree" for the angle unit.

SetDeriv

Syntax: SetDeriv $\left\{ \begin{array}{l} \text{On} \\ \text{Off} \end{array} \right\}$

Function: Turns display of Graph window pointer coordinates and ordered pair table derivative on or off.



SetDispGCon

Syntax: SetDispGCon $\left\{ \begin{array}{l} \text{On} \\ \text{Off} \end{array} \right\}$

Function: Turns display of graph controller arrows during graphing on or off.

SetDrawCon

Syntax: SetDrawCon

Function: Specifies graphing by connecting plotting points with lines.

SetDrawPlt

Syntax: SetDrawPlt

Function: Specifies graphing by plotting points only.

SetFix

Syntax: SetFix <integer from 0 to 9>

Function: Specifies the fixed number of decimal places.

SetFunc

Syntax: SetFunc $\left\{ \begin{array}{l} \text{On} \\ \text{Off} \end{array} \right\}$

Function: Turns display of graph function name and function on or off.

SetGrad

Syntax: SetGrad

Function: Specifies “Grad” for the angle unit.

SetGrid

Syntax: SetGrid $\left\{ \begin{array}{l} \text{On} \\ \text{Off} \end{array} \right\}$

Function: Turns display of the Graph window grid on or off.

SetLabel

Syntax: SetLabel $\left\{ \begin{array}{l} \text{On} \\ \text{Off} \end{array} \right\}$

Function: Turns display of Graph window axis labels on or off.



SetLabel3D

Syntax: SetLabel3D $\left\{ \begin{array}{l} \text{On} \\ \text{Off} \end{array} \right\}$

Function: Turns display of Graph window axis labels for 3D graphing on or off.

SetLeadCursor

Syntax: SetLeadCursor $\left\{ \begin{array}{l} \text{On} \\ \text{Off} \end{array} \right\}$

Function: Turns display of the leading cursor during graphing on or off.

SetNormal

Syntax: SetNormal $\left\{ \begin{array}{l} 1 \\ 2 \end{array} \right\}$

Function: Specifies Normal 1 or Normal 2 as the auto exponential display setting for values.

SetRadian

Syntax: SetRadian

Function: Specifies “Radian” for the angle unit.

SetReal

Syntax: SetReal

Function: Specifies the Real mode (to perform real number calculations).

SetSci

Syntax: SetSci <integer from 0 to 9>

Function: Specifies the fixed number of significant digits.



SetSequence

Syntax: SetSequence $\left\{ \begin{array}{l} \text{On} \\ \text{Off} \\ \text{StepDisp} \end{array} \right\}$

Function: Turns display of expressions created after graphing on or off or specifies “step display” (**StepDisp**).

Description: When **StepDisp** is selected, the expression does not appear until you press .

SetSimulGraph

Syntax: SetSimulGraph $\left\{ \begin{array}{l} \text{On} \\ \text{Off} \end{array} \right\}$

Function: Turn simultaneous drawing of multiple graphs on or off.

SetSmryTable

Syntax: SetSmryTable $\left\{ \begin{array}{l} \text{<list name>} \\ \text{VWin} \end{array} \right\}$

Function: Specifies whether summary table generation is View Window dependent or List dependent. Using **VWin** specifies View Window dependent.

SetSmryTableQD

Syntax: SetSmryTableQD $\left\{ \begin{array}{l} \text{On} \\ \text{Off} \end{array} \right\}$

Function: Specifies whether the second derivative will appear in summary tables.

SetStandard

Syntax: SetStandard

Function: Specifies the Standard mode (to leave calculation results as expressions).

SetStatWinAuto

Syntax: SetStatWinAuto $\left\{ \begin{array}{l} \text{On} \\ \text{Off} \end{array} \right\}$

Function: Turns automatic setup of Statistics application View Window on or off.



DelFolder

Syntax: DelFolder□<folder name>

Function: Deletes a folder.

DelVar

Syntax: DelVar□<variable name>, <variable name> ...

Function: Deletes a variable.

Description: Deletes all variables, regardless of type (program, etc.), that have the specified variable name. See **GetType** for information about variable types.

GetFolder

Syntax: GetFolder□<storage variable name>

Function: Gets the current folder name and assigns it to a variable as a text string.

GetType

Syntax: GetType□<variable name>, <storage variable name>

Function: Gets the type of the specified variable and assigns it to a storage variable as a text string.

Description: The following is a list of variable types.

- NUM (real number type)
- EXPR (expression type)
- STR (string type)
- LIST (list type)
- MAT (matrix type)
- PRGM (program type)
- EXE (execute only program type)
- TEXT (text type)
- FUNC (function type)
- PICT (picture type)
- GMEM (graph expression memory type)
- GEO (geometric type)
- MEM (universal data type)
- OTHR (unrecognizable items)
- NONE (no applicable variable)



Local

Syntax: Local □ <variable name>, <variable name> ...

Function: Defines a local variable.

Description

The following are the merits of local variables.

- Since local variables are deleted automatically, use of local variables for temporary storage avoids unnecessary use of available memory.
- Since local variables do not affect general variables, you can name local variables without worrying about whether the name you are using is already used by another variable.

Lock

Syntax: Lock □ <variable name>, <variable name> ...

Function: Locks variables.

LockFolder

Syntax: LockFolder □ <folder name>

Function: Locks the specified folder and all the files currently inside of it.

MoveVar

Syntax: MoveVar □ <variable name>, <current folder name>, <destination folder name>

Function: Moves a variable to the specified folder.

NewFolder

Syntax: NewFolder □ <folder name>

Function: Creates a new folder.

Rename

Syntax: Rename □ <current variable name>, <new variable name>

Function: Renames a variable.



SetFolder

Syntax: SetFolder□<folder name> [,<storage variable name>]

Function

- Makes the specified folder the current folder. Including a variable name at the end of this command assigns the name of the previous current folder to the variable as a text string.
- If the specified folder does not exist, this command creates a new folder with the specified name, and makes it the current folder.

Unlock

Syntax: Unlock□<variable name>, <variable name> ...

Function: Unlocks variables.

UnlockFolder

Syntax: UnlockFolder□<folder name>

Function: Unlocks the specified folder and all the files currently inside of it.

■ Strings

A string is a series of characters inside of quotation marks. In a program, strings are used to specify display text.

A string made up of numbers (like “123”) or an expression (like “x-1”) cannot be processed as a calculation.

To include quotation marks (") or a backslash (\) in a string, put a backslash (\) in front of the quotation marks (") or backslash (\).

Example 1: To include Japan: “Tokyo” in a string

```
Print□"Japan:\"Tokyo\""
```

Example 2: To include main\abc in a string

```
Print□"main\\abc"
```

ChrToNum

Syntax: ChrToNum□"<string>", <storage variable name>[,*n*]

Function: Converts the characters up to the *n*th character of a string to their character code values and assigns the string to the specified variable.

Description: Omitting “*n*” starts conversion from the first character of the string. For information about character codes, see Appendix page α-6-1.



ExpToStr

Syntax: ExpToStr □ <expression>, <storage variable name>

Function: Converts the result of an input expression to a string and assigns the string to the specified variable.

NumToChr

Syntax: NumToChr □ *n*, <storage variable name>

Function: Converts numeric value *n* to the corresponding text character(s) in accordance with the character code table, and assigns the character(s) as a string to the specified variable. For information about character codes, see Appendix page *α-6-1*.

NumToStr

Syntax: NumToStr □ <value>, { "Fix <integer from 0 to 9>" }, <storage variable name>
 { "Sci <integer from 0 to 9>" }

Function: Converts a numeric value to a string of the specified format, and assigns the resulting string to the specified variable.

Example: NumToStr 1.234, "Fix2", *x*

StrCmp

Syntax: StrCmp □ "<string 1>", "<string 2>", <storage variable name>

Function: Compares "<string 1>" and "<string 2>" (character code comparison) and assigns the resulting value to the specified variable.

Description

- Returns 0 when "<string 1>" = "<string 2>".
- Returns 1 when "<string 1>" > "<string 2>".
- Returns -1 when "<string 1>" < "<string 2>".

StrInv

Syntax: StrInv □ "<string>", <storage variable name>

Function: Inverts the sequence of a string and assigns the resulting string to a variable.



StrJoin

Syntax: StrJoin □ "<string 1>", "<string 2>", <storage variable name>

Function: Joins "<string 1>" and "<string 2>" and then assigns the resulting string to the specified variable.

StrLeft

Syntax: StrLeft □ "<string>", *n*, <storage variable name>

Function: Copies a string up to the *n*th character from the left, and assigns the resulting string to the specified variable.

StrLen

Syntax: StrLen □ "<string>", <storage variable name>

Function: Determines the length of a string (the number of its characters) and assigns the resulting value to the specified variable.

StrLwr

Syntax: StrLwr □ "<string>", <storage variable name>

Function: Converts all the characters of a string to lower case and assigns the resulting string to the specified variable.

StrMid

Syntax: StrMid □ "<string>", *n*, <storage variable name> [, <number of characters>]

Function: Copies a specific number of characters of a string, starting from the *n*th character, and assigns the resulting string to the specified variable.

Description: Omitting the number of characters causes the string to be copied up to the end.

StrRight

Syntax: StrRight □ "<string>", *n*, <storage variable name>

Function: Copies a string up to the *n*th character from the right, and assigns the resulting string to the specified variable.



StrRotate

Syntax: StrRotate □ "<string>", <storage variable name> [,*n*]

Function: Rotates the left side part and right side part of a string at the *n*th character, and assigns the resulting string to the specified variable.

Description: Rotation is to the left when "*n*" is positive, and to the right when "*n*" is negative. Omitting "*n*" uses a default value of +1.

Example: StrRotate "abcde", DDD, -2 ← Assigns the string "deabc" to variable DDD.

StrShift

Syntax: StrShift □ "<string>", <storage variable name> [,*n*]

Function: Shifts a string left or right *n* characters, and assigns the resulting string to the specified variable.

Description: Shift is to the left when "*n*" is positive, and to the right when "*n*" is negative. Omitting "*n*" uses a default value of +1.

Example: StrShift "abcde", DDD, -2 ← Assigns the string " abc" to variable DDD.

StrSrc

Syntax: StrSrc □ "<string 1>", "<string 2>", <storage variable name>
[,<search start location>]

Function: Searches "<string 1>" starting from the specified point (*n*th character from beginning of string) to determine if it contains the data specified by "<string 2>". If the data is found, this command returns the location of the first character of "<string 2>", starting from the beginning of "<string 1>".

Description: Omitting the start point causes the search to start from the beginning of "<string 1>".

strToExp(

Syntax: strToExp("<string>")

Function: Converts a string to an expression, and executes the expression.

StrUpR

Syntax: StrUpR □ "<string>", <storage variable name>

Function: Converts all the characters of a string to upper case and assigns the resulting string to the specified variable.



Other

CloseComPort38k

Syntax: CloseComPort38k

Function: Closes the 3-pin COM port.

Example: See the **GetVar38k** command.

GetVar38k

Syntax: GetVar38k □ <variable name>

Function: Receives variable names and variable contents.

Description

- The **OpenComPort38k** command must be executed before this command is executed.
- The **CloseComPort38k** command must be executed after this command is executed.

Example: To connect two ClassPad units with an SB-62 cable, and transfer the contents of the sending unit's variable "s" to the receiving unit's variable "g"

Sending Unit Program

```
123 ⇒ s
OpenComPort38k
SendVar38k s
CloseComPort38k
```

Receiving Unit Program

```
OpenComPort38k
GetVar38k g
CloseComPort38k
```

Notes

- Run the receiving unit's program first, and then run the sending unit's program.
- You can use any commands beside the four data communication commands (**Send38k**, **Receive38k**, **SendVar38k**, or **GetVar38k**) between the **OpenComPort38k** and **CloseComPort38k** commands.



OpenComPort38k

Syntax: OpenComPort38k

Function: Opens the 3-pin COM port.

Example: See the **GetVar38k** command on page 12-6-45.

Receive38k

Syntax: Receive38k□<variable name>

Function: Receives EA-200 data.

Description

- The **OpenComPort38k** command must be executed before this command is executed.
- The **CloseComPort38k** command must be executed after this command is executed.
- For details about using this command, see the user documentation that comes with the EA-200.
- Note that you need to replace all instances of the **Receive** command in the examples provided in the EA-200 user documentation with the command **Receive38k**. You should also adjust the other commands in the EA-200 examples so they conform to the ClassPad command syntax and usage as described in this manual.

Send38k

Syntax: Send38k□<variable name>

Function: Sends EA-200 data.

Description

- The **OpenComPort38k** command must be executed before this command is executed.
- The **CloseComPort38k** command must be executed after this command is executed.
- For details about using this command, see the user documentation that comes with the EA-200.
- Note that you need to replace all instances of the **Send** command in the examples provided in the EA-200 user documentation with the command **Send38k**. You should also adjust the other commands in the EA-200 examples so they conform to the ClassPad command syntax and usage as described in this manual.
- <variable name> must be a variable that contains a real number or a list. Anything else results in an error.

SendVar38k

Syntax: SendVar38k□<variable name>

Function: Sends variable names and variable contents.

Description

- The **OpenComPort38k** command must be executed before this command is executed.
- The **CloseComPort38k** command must be executed after this command is executed.

Example: See the **GetVar38k** command on page 12-6-45.



12-7 Including ClassPad Functions in Programs

Including Graphing Functions in a Program

Graphing functions let your program graph multiple equations, or overlay multiple graphs on the same screen.

Example: DefaultSetup
 ClrGraph
 ViewWindow 0, 7.7, 1, -14, 110, 10
 GraphType "y="
 Define $y_1(x) = x^4 - x^3 - 24x^2 + 4x + 80$
 GTSelOn 1
 PTDot 1
 SheetActive 1
 DrawGraph

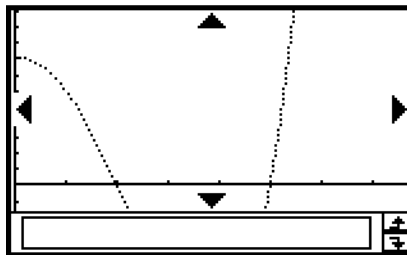

Using Conics Functions in a Program

Conics functions make it possible for your program to draw conics graphs.

Example: ClrGraph
 ViewWindow -15.4, 15.4, 2, -7.6, 7.6, 2
 " $(x - 1)^2/3^2 + (y - 2)^2/4^2 = 1$ " \Rightarrow ConicsEq
 DrawConics

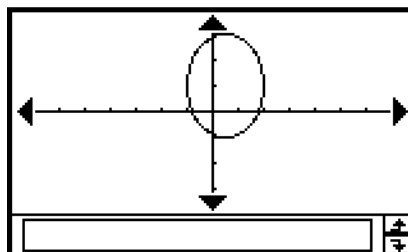

Including 3D Graphing Functions in a Program

The methods for using 3D graphing functions in a program are identical to those for normal (non-3D) graphing functions, except that you can only graph one 3D graph at a time. For information about commands that are unique to 3D graphing, see "3D" on page 12-6-24.

Including Table & Graph Functions in a Program

Table & Graph functions can be included in a program to generate number tables and draw graphs.

Example: DefaultSetup
 ClrGraph
 ViewWindow 0, 7.7, 1, -14, 110, 10
 GraphType "y="
 Define $y_1(x) = 3 \times x^2 - 2$
 GTSelOn 1
 0 \Rightarrow FStart
 6 \Rightarrow FEnd
 1 \Rightarrow FStep
 SheetActive 1
 DispFTable
 Pause
 DrawFTGCon

x	y1
0	-2
1	1
2	10
3	25
4	46

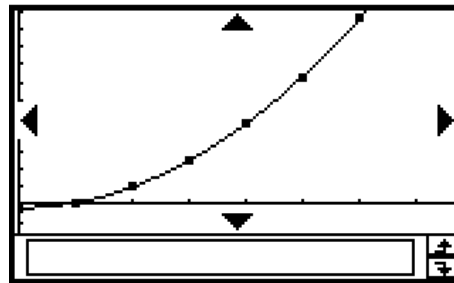

Including Recursion Table and Recursion Graph Functions in a Program

Recursion table and recursion graph functions can be included in a program to generate number tables and draw graphs.

Example: DefaultSetup
 ViewWindow 0, 6, 1, -0.01, 0.3, 1
 SeqType "a_{n+1}a₀"
 "-3a_n² + 2a_n" ⇒ a_{n+1}
 0 ⇒ SqStart
 6 ⇒ SqEnd
 0.01 ⇒ a₀
 DispSeqTbl
 Pause
 DrawSeqCon

n	a _n
0	0.01
1	0.0197
2	0.0382
3	0.072
4	0.1285

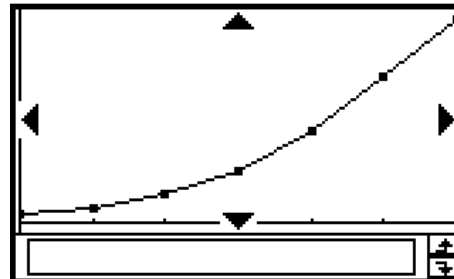

Including List Sort Functions in a Program

List sort functions let you sort list data into either ascending or descending order. Make sure the list contains data before executing a sort function.

- **To sort data of a single list in ascending order**

MultiSortA <list name>

- **To sort multiple lists in ascending order, based on the data in one list**

MultiSortA <base list name>,<list name>,...

- Up to six list names can be specified, including the base list name.

- **To sort data of a single list in descending order**

MultiSortD <list name>

- **To sort multiple lists in descending order, based on the data in one list**

MultiSortD <base list name>,<list name>,...

- Up to six list names can be specified, including the base list name.

Including Statistical Graphing and Calculation Functions in a Program

Including statistical graphs and calculation functions in a program allows the program to draw statistical graphs and display statistical calculation results.

• To perform statistical graphing

Example 1: Scatter Diagram

```
{0.5, 1.2, 2.4, 4, 5.2} ⇒ list1
{-2.1, 0.3, 1.5, 2, 2.4} ⇒ list2
StatGraph 1, On, Scatter, list1, list2, 1, Square
DrawStat
```

Note that **xyLine** can also be specified in instead of **Scatter** for the graph type.

Example 2: Normal Probability Plot

```
{0.5, 1.2, 2.4, 4, 5.2} ⇒ list1
StatGraph 1, On, NPPlot, list1, Square
DrawStat
```

Example 3: Single-variable statistical graphing

```
{0.5, 1.2, 2.4, 4, 5.2} ⇒ list1
StatGraph 1, On, Histogram, list1, list1
DrawStat
```

Note that **MedBox**, **ModBox**, **NDist**, or **Broken** can also be specified in instead of **Histogram** for the graph type.

Example 4: Paired-variable statistical graphing

```
{0.5, 1.2, 2.4, 4, 5.2} ⇒ list1
{-2.1, 0.3, 1.5, 2, 2.4} ⇒ list2
StatGraph 1, On, LinearR, list1, list2, 1
DrawStat
```

Note that **MedMed**, **QuadR**, **CubicR**, **QuartR**, **LogR**, **ExpR**, **abExpR**, or **PowerR** can also be specified in instead of **LinearR** for the graph type.

Example 5: Paired-variable statistical graphing (Sinusoidal Regression / Logistic Regression)

```
{0.5, 1.2, 2.4, 4, 5.2} ⇒ list1
{2.9, 3.8, 3.3, 0.4, 0.2} ⇒ list2
StatGraph 1, On, SinR, list1, list2
DrawStat
```

Note that **LogisticR** can also be specified in instead of **SinR** for the graph type.



• To use statistical calculation functions

You can perform the following types of statistical calculations using program commands.

- Single-variable statistics
- Paired-variable statistics
- Regression
- Tests
- Confidence interval
- Probability

See “Chapter 7 – Using the Statistics Application” for more information.

• To explore statistical data**Example: Exploring data with regression**

```
StatGraphSel Off
```

```
{0.5, 1.2, 2.4, 4, 5.2} ⇒ list1
```

```
{-2.1, 0.3, 1.5, 2, 2.4} ⇒ list2
```

```
StatGraph 1, On, Scatter, list1, list2, 1, Square
```

```
DrawStat
```

```
LogReg list1, list2, 1
```

```
DispStat
```

```
DrawStat
```



Chapter 13

Using the Spreadsheet Application

The Spreadsheet application provides you with powerful, take-along-anywhere spreadsheet capabilities on your ClassPad.

- 13-1 Spreadsheet Application Overview**
- 13-2 Spreadsheet Application Menus and Buttons**
- 13-3 Basic Spreadsheet Window Operations**
- 13-4 Editing Cell Contents**
- 13-5 Using the Spreadsheet Application with the eActivity Application**
- 13-6 Statistical Calculations**
- 13-7 Cell and List Calculations**
- 13-8 Formatting Cells and Data**
- 13-9 Graphing**

13

13-1 Spreadsheet Application Overview

This section describes the configuration of the Spreadsheet application window, and provides basic information about its menus and commands.

Starting Up the Spreadsheet Application

Use the following procedure to start up the Spreadsheet application.

- **ClassPad Operation**

On the application menu, tap  Spreadsheet.

This starts the Spreadsheet application and displays its window.

Spreadsheet Window

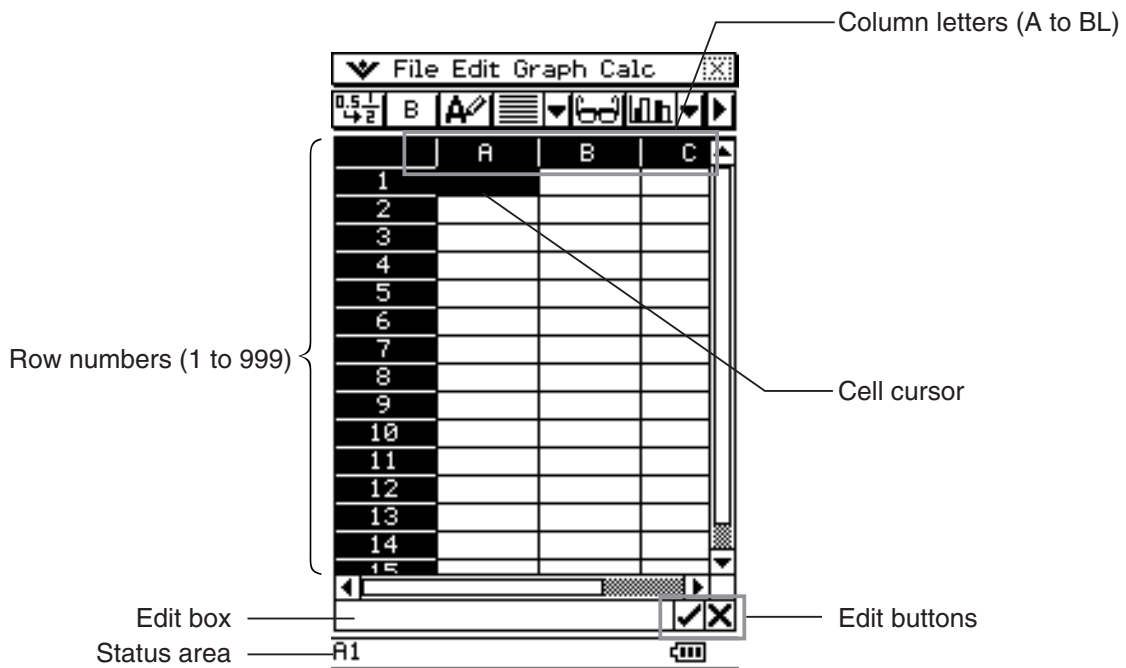

The Spreadsheet window shows a screen of cells and their contents.



- Each cell can contain a value, expression, text, or a formula. Formulas can contain a reference to a specific cell or a range of cells.

13-2 Spreadsheet Application Menus and Buttons

This section explains the operations you can perform using the menus and buttons of the Spreadsheet application window.

- For information about the  menu, see “Using the  Menu” on page 1-5-4.

■ File Menu

To do this:	Select this [File] menu item:
Create a new, empty spreadsheet	New
Open an existing spreadsheet	Open
Save the currently displayed spreadsheet	Save
Import data to spreadsheet	Import
Export spreadsheet data	Export
Recalculate the contents of the cell(s) on the spreadsheet	Recalculate



■ Edit Menu

To do this:	Select this [Edit] menu item:
Undo the last action, or redo the action you have just undone	Undo/Redo
Display a dialog box that lets you show or hide scrollbars, and specify the direction the cursor advances when inputting data	Options
Automatically resize columns to fit the data into the selected cells	AutoFit Selection
Display a dialog box for specifying column width	Column Width
Display a dialog box for specifying the number format of the selected cell(s)	Number Format
Display or hide the Cell Viewer window	Cell Viewer
Display a dialog box for specifying a cell to jump to	Goto Cell
Display a dialog box for specifying a range of cells to select	Select Range
Display a dialog box for specifying cell contents and a range of cells to fill	Fill Range
Display a dialog box for specifying a sequence to fill a range of cells	Fill Sequence
Insert row(s)	Insert - Rows
Insert column(s)	Insert - Columns
Delete the currently selected row(s)	Delete - Rows
Delete the currently selected column(s)	Delete - Columns
Delete the contents of the currently selected cells	Delete - Cells
Cut the current selection and place it onto the clipboard	Cut
Copy the current selection and place it onto the clipboard	Copy
Paste the clipboard contents at the current cell cursor location	Paste
Select everything in the spreadsheet	Select All
Sort cell(s) on the spreadsheet	Sort
Search for strings in the cell(s) on the spreadsheet	Search
Search for strings in the cell(s) on the spreadsheet again	Search Again
Clear all data from the spreadsheet	Clear All

■ Graph Menu

You can use the [Graph] menu to graph the data contained in selected cells. See “13-9 Graphing” for more information.

■ Calc Menu

The [Calc] menu includes commands to perform the following calculations.

- Statistical calculations (Single-variable and paired-variable statistics, regression, tests, confidence interval, distribution, inverse distribution)
- Cell calculations (row, col, count, celllf) and list calculations









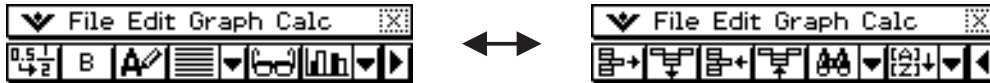











For more information, see “13-6 Statistical Calculations” and “13-7 Cell and List Calculations”.



■ Spreadsheet Toolbar Buttons

Not all of the Spreadsheet buttons can fit on a single toolbar, tap the  button on the far right to toggle between the two toolbars.



To do this:	Tap this button:
Toggle the selected cell(s) between decimal (floating point) and exact display* ¹	 / 
Toggle the selected cell(s) between bold and normal	 / 
Toggle the data type of the selected cell(s) between text and calculation	 / 
Specify left-justified text and right-justified values for selected cell(s) (default)	
Specify left-justified for selected cell(s)	
Specify centered for selected cell(s)	
Specify right-justified for selected cell(s)	
Display or hide the Cell Viewer window	
Display the Spreadsheet Graph window (page 13-9-1)	
Delete the currently selected row(s)	
Delete the currently selected column(s)	
Insert row(s)	
Insert column(s)	
Search for strings in the cell(s) on the spreadsheet	 / 
Sort cell(s) on the spreadsheet	 / 

*¹ When cell(s) are calculation data types.

Tip

- During cell data input and editing, the toolbar changes to a data input toolbar. See “Edit Mode Screen” on page 13-4-1 for more information.



13-3 Basic Spreadsheet Window Operations

This section contains information about how to control the appearance of the Spreadsheet window, and how to perform other basic operations.

About the Cell Cursor

The cell cursor causes the current selected cell or group of cells to become highlighted. The location of the current selection is indicated in the status bar, and the value or formula located in the selected cell is shown in the edit box.

- You can select multiple cells for group formatting, deletion, or insertion.
- See “Selecting Cells” on page 13-3-5 for more information about selecting cells.

Controlling Cell Cursor Movement

Use the following procedure to specify whether the cell cursor should stay at the current cell, move down to the next line, or move right to the next column when you register data in a Spreadsheet cell.

• ClassPad Operation

- (1) On the [Edit] menu, tap [Options].

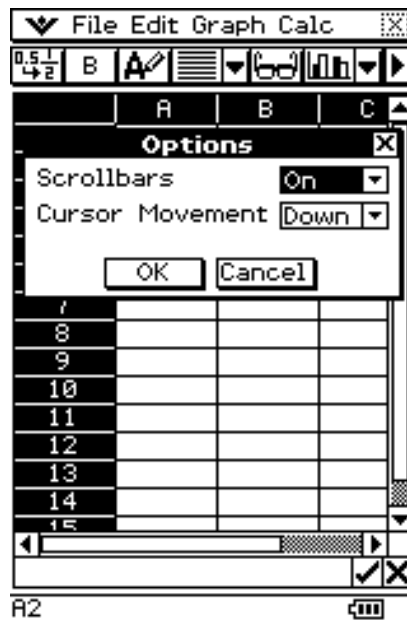

- (2) On the dialog box that appears, tap the [Cursor Movement] down arrow button, and then select the setting you want.

To have the cell cursor behave this way when you register input:	Select this setting:
Remain at the current cell	Off
Move to the next row below the current cell	Down
Move to the next column to the right of the current cell	Right

- (3) After the setting is the way you want, tap [OK].

Navigating Around the Spreadsheet Window

The simplest way to select a cell is to tap it with the stylus. You can also drag the stylus across a range of cells to select all of them. If you drag to the edge of the screen, it will scroll automatically, until you remove the stylus from the screen.

The following are other ways you can navigate around the Spreadsheet window.

■ Cursor Keys

When a single cell is selected, you can use the cursor key to move the cell cursor up, down, left, or right.



■ Jumping to a Cell

You can use the following procedure to jump to a specific cell on the Spreadsheet screen by specifying the cell's column and row.

● ClassPad Operation

- (1) On the [Edit] menu, select [Goto Cell].



- (2) On the dialog box that appears, type in a letter to specify the column of the cell to which you want to jump, and a value for its row number.
- (3) After the column and row are the way you want, tap [OK] to jump to the cell.



Hiding or Displaying the Scrollbars

Use the following procedure to turn display of Spreadsheet scrollbars on and off. By turning off the scrollbars, you make it possible to view more information in the spreadsheet.

• ClassPad Operation

- (1) On the [Edit] menu, tap [Options].

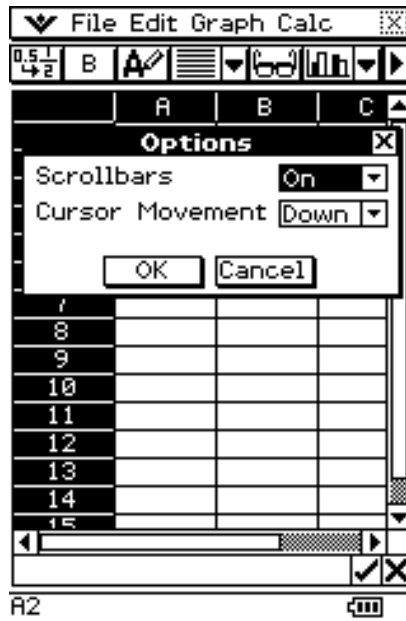

- (2) On the dialog box that appears, tap the [Scrollbars] down arrow button, and then select the setting you want.

To do this:	Select this setting:
Display the scrollbars	On
Hide the scrollbars	Off

- (3) After the setting is the way you want, tap [OK].



Selecting Cells

Before performing any operation on a cell, you must first select it. You can select a single cell, a range of cells, all the cells in a row or column, or all of the cells in the spreadsheet.

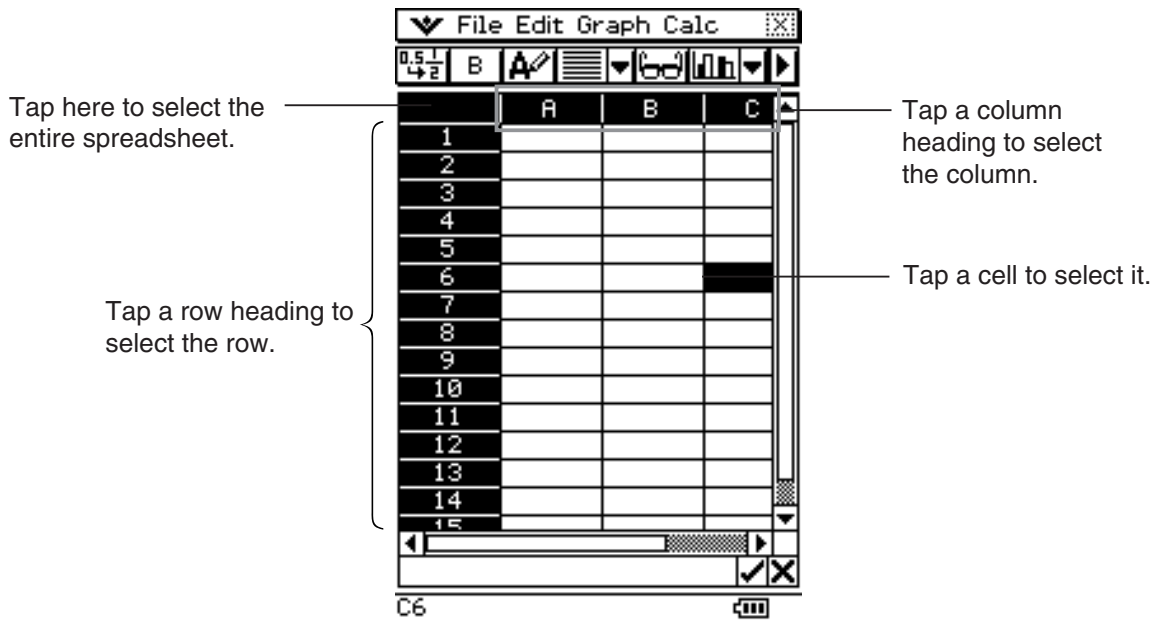

- To select a range of cells, drag the stylus across them.

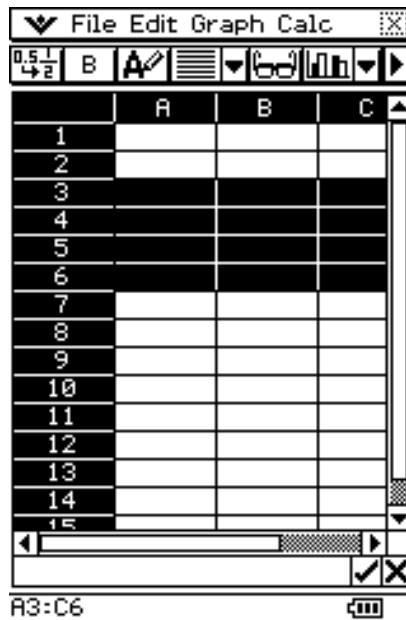

Using the Cell Viewer Window

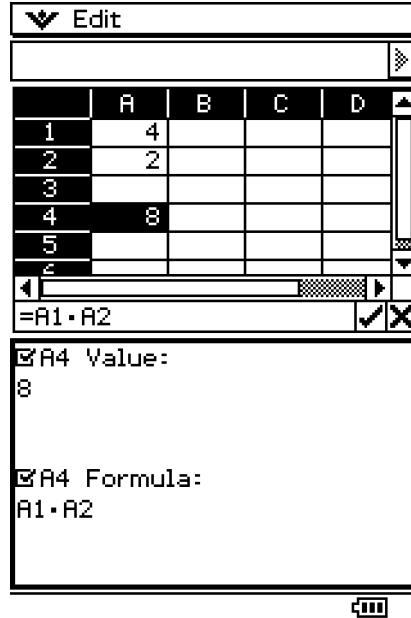

The Cell Viewer window lets you view both the formula contained in a cell, as well as the current value produced by the formula.



While the Cell Viewer window is displayed, you can select or clear its check boxes to toggle display of the value and/or formula on or off. You can also select a value or formula and then drag it to another cell.

• To view or hide the Cell Viewer window

On the Spreadsheet toolbar, tap . Or, on the Spreadsheet [Edit] menu, select [Cell Viewer].

- The above operation toggles display of the Cell Viewer window on and off.
- You can control the size and location of the Cell Viewer window using the  and  icons on the icon panel below the touch screen. For details about these icons, see “1-3 Using the Icon Panel”.



13-4 Editing Cell Contents

This section explains how to enter the edit mode for data input and editing, and how to input various types of data and expressions into cells.

Edit Mode Screen

The Spreadsheet application automatically enters the edit mode whenever you tap a cell to select it and input something from the keypad.

Entering the edit mode (see page 13-4-2) displays the editing cursor in the edit box and the data input toolbar.

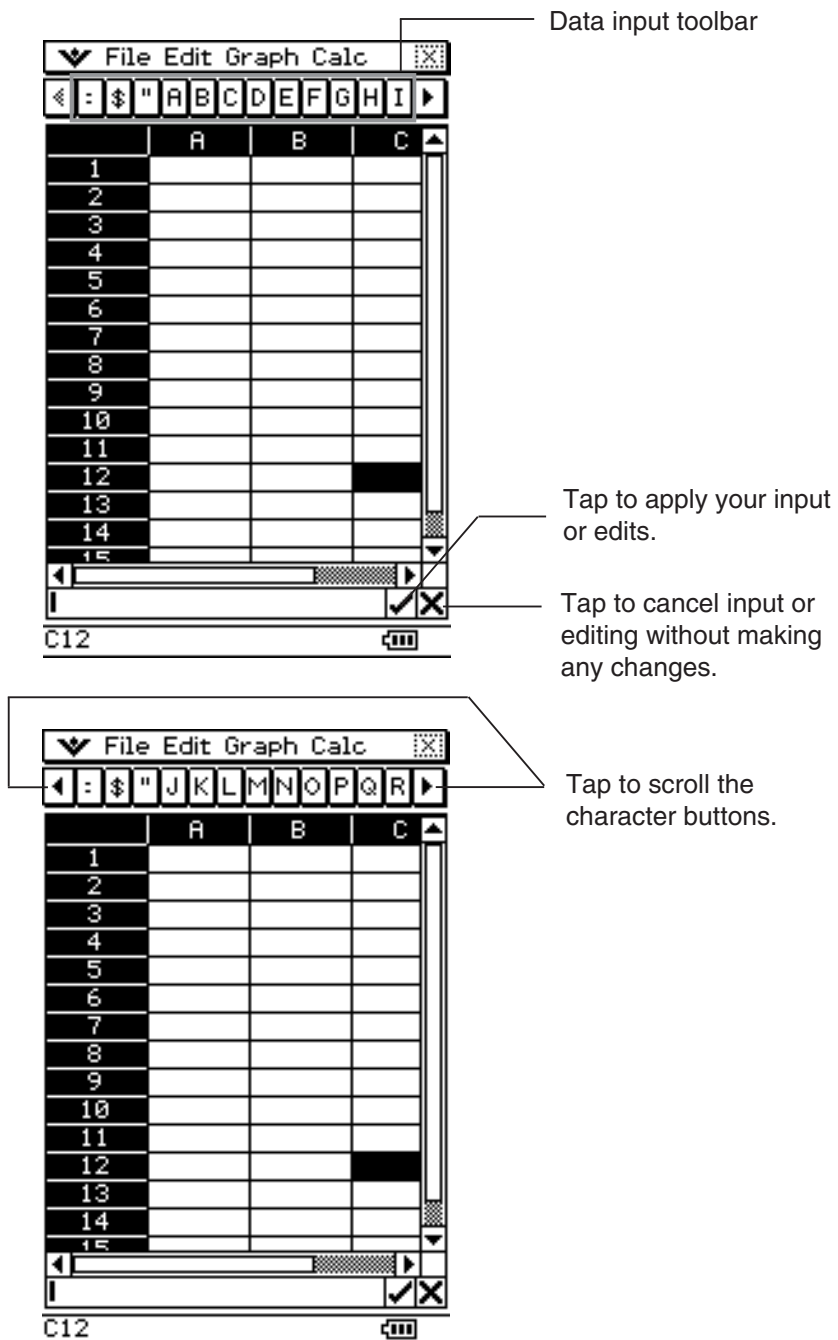

13-4-2
Editing Cell Contents

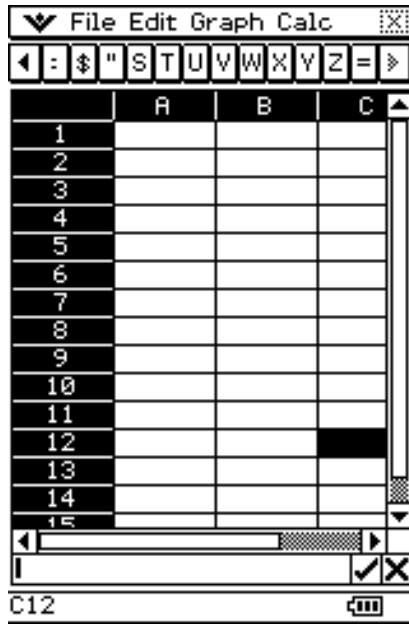

- You can tap the data input toolbar buttons to input letters and symbols into the edit box.

Entering the Edit Mode

There are two ways you can enter the edit mode:

- Tapping a cell and then tapping inside the edit box
- Tapping a cell and inputting something on the keypad

The following explains the difference between these two techniques.

■ Tapping a cell and then tapping the edit box

- This enters the “standard” edit mode.
- Tapping the edit box selects (highlights) all of the text in the edit box. Tapping the edit box again deselects (unhighlights) the text and displays the editing cursor (a solid blinking cursor).
- Be sure to use this standard editing mode when you want to correct or change the existing contents of a cell.
- The following explains the operation of the cursor key after entering the standard editing mode.

To move the editing cursor here in the edit box text:	Press this cursor key:
One character left	◀
One character right	▶
To the beginning (far left)	⬅
To the end (far right)	➡



■ Tapping a cell and then inputting something from the keypad

- This enters the “quick” edit mode, indicated by a dashed blinking cursor. Anything you input with the keypad will be displayed in the edit box.
- If the cell you selected already contains something, anything you input with the quick edit mode replaces the existing content with the new input.
- In the quick editing mode, pressing the cursor key registers your input and moves the cell cursor in the direction of the cursor key you press.
- Note that you can change to the standard edit mode at any time during the quick edit mode by tapping inside of the edit box.

Basic Data Input Steps

The following are the basic steps you need to perform whenever inputting or editing cell data.

● ClassPad Operation





(1) Enter the edit mode.

- Either tap a cell (quick edit), or tap a cell and then tap the edit box (standard edit).
- See “Selecting Cells” on page 13-3-5 for more information about selecting cells.

(2) Input the data you want.

- You can input data using the keypad, the [Calc] menu, and the input toolbar. See the following sections for more information.

(3) After you are finished, finalize the input using one of the procedures below.

If you are using this edit mode:	Do this to finalize your input:
Standard Edit	<ul style="list-style-type: none"> • Tap the  button next to the edit box. • Press the  key.
Quick Edit	<ul style="list-style-type: none"> • Press a cursor key. • Or tap the  button next to the edit box. • Or press the  key.

- This causes the entire spreadsheet to be re-calculated.
- If you want to cancel data input without saving your changes, tap the  button next to the edit box or tap **ESC** on the icon panel.

Important!

- You can also finalize input into a cell by tapping a different cell, *as long as the first character in the edit box is not an equal sign (=)*. Tapping another cell while the first character in the edit box is an equal sign (=) inserts a reference to the tapped cell into the edit box. See “Inputting a Cell Reference” on page 13-4-6 for more information.



Inputting a Formula

A formula is an expression that the Spreadsheet application calculates and evaluates when you input it, when data related to the formula is changed, etc.

A formula always starts with an equal sign (=), and can contain any one of the following.

- Values
- Mathematical expressions
- Cell references
- ClassPad soft keyboard functions (cat page of keyboard)
- [Calc] menu functions (page 13-7-4)

Formulas are calculated dynamically whenever related values are changed, and the latest result is always displayed in the spreadsheet.

The following shows a simple example where a formula in cell B5 calculates the average of the values in cells B1 through B3.

	A	B
1	Data 1	2.50
2	Data 2	2.30
3	Data 3	2.51
4		
5	Average	2.44
6		
7		
8		
9		
10		
11		
12		
13		
14		
15		

Formula Bar: =(B1+B2+B3)/3

Status Bar: B5 2.436666667

Important!

- Tapping another cell while the first character in the edit box is an equal sign (=) inserts a reference to the tapped cell into the edit box. Dragging across a range of cells will input a reference to the selected range. See “Inputting a Cell Reference” on page 13-4-6 for more information.
- When a cell is set to text data type, formulas are displayed as text when they are not preceded by an equal sign (=).
- When a cell is set to calculation data type, an error occurs when a formula is not preceded by an equal sign (=).

• To use the soft keyboards to input a function

Example: To input the following

Cell A1: $x^{\text{row}(A1)}$

Cell B1: $\text{diff}(A1, x, 1)$

(1) Tap cell A1 to select it.

(2) Press = , (x) , and then (\wedge) .

13-4-5
Editing Cell Contents

(3) Press **Keyboard** to display the soft keyboard.

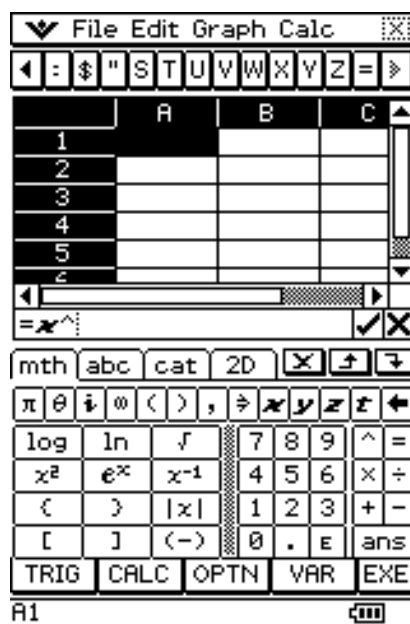

(4) Tap the **abc** tab and then tap **r**, **o**, **w**, then press **⏏**, or on the [Calc] menu, tap [row].

(5) Tap cell A1, and then press **⏏**.

(6) Press **EXE**.

(7) Tap cell B1 and then press **⊖**.

(8) On the soft keyboard, tap the **math** tab, tap **CALC**, and then tap **diff**.

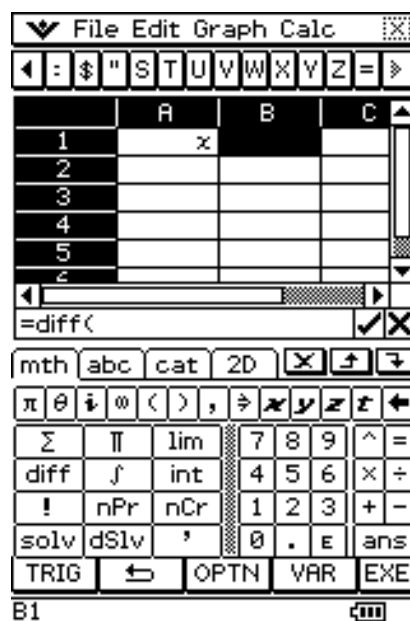

(9) Tap cell A1, press **⏏**, **x**, **⏏**, **1**, and then press **⏏**.

(10) Press **EXE**.

(11) Press **Keyboard** to hide the soft keyboard.

(12) Select (highlight) cells A1 and B1.

(13) On the [Edit] menu, tap [Copy].

(14) Select cells A2 and B2.

(15) On the [Edit] menu, tap [Paste].

- Learn more about cell referencing below.

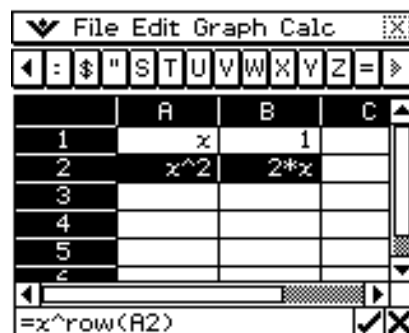

Inputting a Cell Reference

A cell reference is a symbol that references the value of one cell for use by another cell. If you input “=A1 + B1” into cell C2, for example, the Spreadsheet will add the current value of cell A1 to the current value of cell B1, and display the result in cell C2.

There are two types of cell references: *relative* and *absolute*. It is very important that you understand the difference between relative and absolute cell references. Otherwise, your spreadsheet may not produce the results you expect.

■ Relative Cell Reference

A relative cell reference is one that changes according to its location on the spreadsheet. The cell reference “=A1” in cell C2, for example, is a reference to the cell located “two columns to the left and one cell up” from the current cell (C2, in this case). Because of this, if we copy or cut the contents of cell C2 and paste them into cell D12, for example, the cell reference will change automatically to “=B11”, because B11 is two columns to the left and one cell up from cell D12.

Be sure to remember that relative cell references always change dynamically in this way whenever you move them using cut and paste, or drag and drop.

Important!

- When you cut or copy a relative cell reference from the edit box, it is copied to the clipboard as text and pasted “as-is” without changing. If “=A1” is in cell C2 and you copy “=A1” from the edit box and paste it into cell D12, for example, D12 will also be “=A1”.



■ Absolute Cell References

An absolute cell reference is the one that does not change, regardless of where it is located or where it is copied to or moved to. You can make both the row and column of a cell reference absolute, or you can make only the row or only the column of a cell reference absolute, as described below.

This cell reference:	Does this:
\$A\$1	Always refers to column A, row 1
\$A1	Always refers to column A, but the row changes dynamically when moved, as with a relative cell reference
A\$1	Always refers to row 1, but the column changes dynamically when moved, as with a relative cell reference

Let's say, for example, that a reference to cell A1 is in cell C1. The following shows what each of the above cell references would become if the contents of cell C1 were copied to cell D12.

\$A\$1 → \$A\$1

\$A1 → \$A12

A\$1 → B\$1

● To input a cell reference

- (1) Select the cell where you want to insert the cell reference.
- (2) Tap inside the edit box.
- (3) If you are inputting new data, input an equal sign (=) first. If you are editing existing data, make sure that its first character is an equal sign (=).
 - Inputting a cell name like "A3" without an equal sign (=) at the beginning will cause "A" and "3" to be input as text, without referencing the data in cell A3.

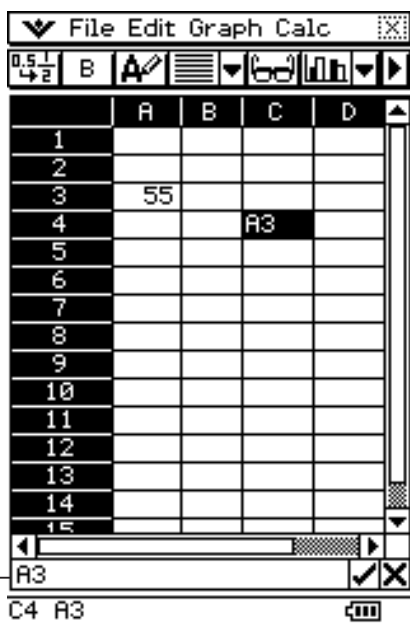

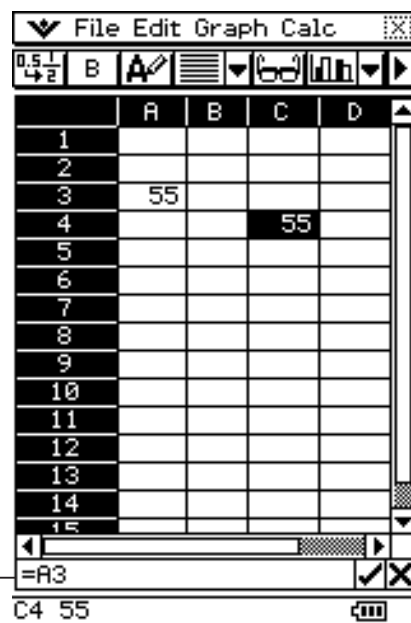

Incorrect cell reference (no "=" sign)



Correct cell reference

- (4) Tap the cell you want to reference (which will input its name into the edit box automatically) or use the editing toolbar and keypad to input its name.

Important!

- The above step always inputs a relative cell reference. If you want to input an absolute cell reference, use the stylus or cursor keys to move the editing cursor to the appropriate location, and then use the editing toolbar to input a dollar (\$) symbol. See “Inputting a Cell Reference” on page 13-4-6 for more information about relative and absolute cell references.
- (5) Repeat step (4) as many times as necessary to input all of the cell references you want. For example, you could input “=A1 + A2”. You can also input a range of cells into the edit box by dragging across a group of cells.
- (6) After your input is the way you want, tap the  button next to the edit box or press the  key to save it.

Inputting a Constant

A constant is data whose value is defined when it is input. When you input something into a cell for which text is specified as the data type without an equal sign (=) at the beginning, a numeric value is treated as a constant and non-numeric values are treated as text.

Note the following examples for cells of  type:

This input:	Is interpreted as:	And is treated as:
sin(1)	A numeric expression	A constant value
1+1/2	A numeric expression	A constant value
1.02389	A numeric expression	A constant value
sin(x)	A symbolic expression	Text
x+y	A symbolic expression	Text
Result	A string expression	Text
sin(Invalid expression context	Text

- When text is too long to fit in a cell, it spills over into the next cell to the right if the neighboring cell is empty. If the cell to the right is not empty, the text is cut off and “...” is displayed to indicate that non-displayed text is contained in the cell.



Using the Fill Sequence Command

The Fill Sequence command lets you set up an expression with a variable, and input a range of values based on the calculated results of the expression.

• To input a range of values using Fill Sequence

Example: To configure a Fill Sequence operation according to the following parameters

Expression: $1/x$
 Change of x Value: From 1 to 25
 Step: 1
 Input Location: Starting from A1

(1) On the [Edit] menu, tap [Fill Sequence].

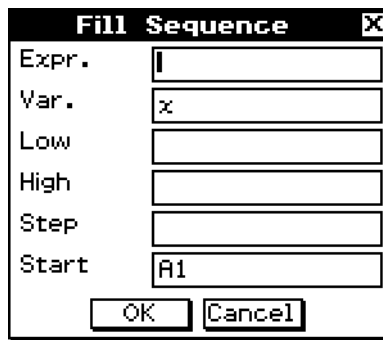

(2) Use the dialog box that appears to configure the Fill Sequence operation as described below.

Parameter	Description
Expr.	Input the expression whose results you want to input.
Var.	Specify the name of the variable whose value will change with each step.
Low	Specify the smallest value to be assigned to the variable.
High	Specify the greatest value to be assigned to the variable.
Step	Specify the value that should be added to the variable value with each step.
Start	Specify the starting cell from which the results of the expression should be inserted.



13-4-10
Editing Cell Contents

- The following shows how the Fill Sequence dialog box should appear after configuring the parameters for our example.

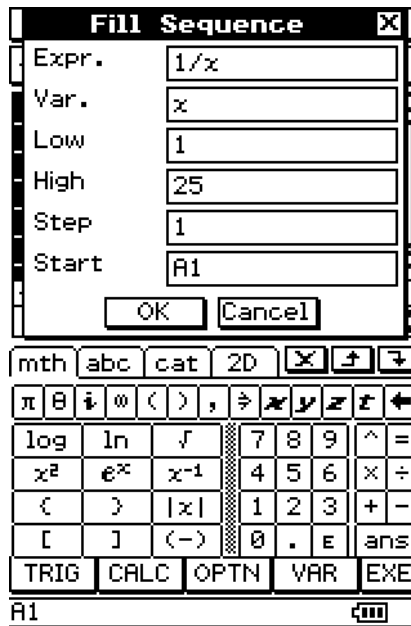

(3) After everything is the way you want, tap [OK].

- This performs all the required calculations according to your settings, and inserts the results into the spreadsheet.
- The following shows the results for our example.

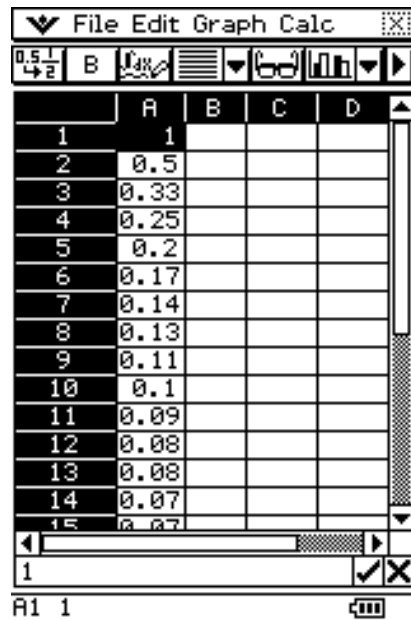

Cut and Copy

You can use the [Cut] and [Copy] commands on the Spreadsheet application [Edit] menu to cut and copy the contents of the cells currently selected (highlighted) with the cell cursor. You can also cut and copy text from the edit box.

The following types of cut/copy operations are supported.

- Single cell cut/copy
- Multiple-cell cut/copy
- Selected edit box text cut/copy
- Cell Viewer values and formulas copy only

Cutting or copying data places it onto the clipboard. You can use the [Paste] command to paste the clipboard contents at the current cell cursor or editing cursor location.

Paste

The [Edit] menu's [Paste] command lets you paste the data that is currently on the clipboard at the current cell cursor or editing cursor location.

Important!

- Pasting cell data will cause all relative cell references contained in the pasted data to be changed in accordance with the paste location. See "Inputting a Cell Reference" on page 13-4-6 for more information.
- Relative cell references in data copied or cut from the edit box do not change when pasted into another cell.

The following summarizes how different types of data can be pasted.

■ When the clipboard contains data from a single cell or the edit box

If you do this:	Executing the [Paste] command will do this:
Select a single cell with the cell cursor	Paste the clipboard data into the selected cell
Select multiple cells with the cell cursor	Paste the clipboard data into each of the selected cells
Locate the editing cursor inside the edit box	Paste the clipboard data at the editing cursor location

■ When the clipboard contains data from multiple cells

If you do this:	Executing the [Paste] command will do this:
Select a single cell with the cell cursor	Paste the clipboard data starting from the selected cell
Select multiple cells with the cell cursor	Paste the clipboard data starting from the first (top left) cell
Locate the editing cursor inside the edit box	Paste the clipboard data at the editing cursor location in matrix format



13-4-12
Editing Cell Contents

- The following shows how cell data is converted to a matrix format when pasted into the edit box.

	A	B	C	D
1	1	8	4	
2	7	2	6	
3	3	6	9	
4				
5				
6				
7				
8				
9				
10				
11				
12				

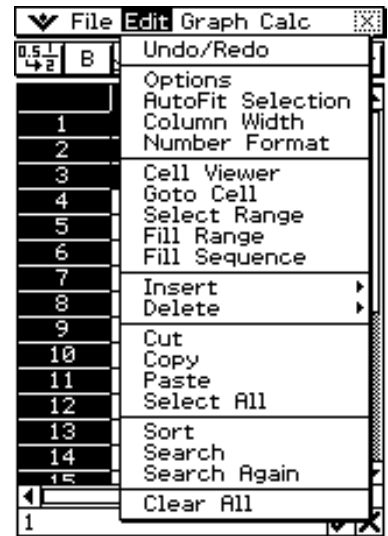

Select the cell where you want to insert the text (A6 in this example), and then tap inside the edit box.

	A	B	C	D
1	1	8	4	
2	7	2	6	
3	3	6	9	
4				
5				
6				
7				
8				
9				
10				
11				
12				
13				
14				

Tap [Edit], and then [Paste].

	A	B	C	D
1	1	8	4	
2	7	2	6	
3	3	6	9	
4				
5				
6	[[1,8,4],[7,2,6],[3,6,9]]			
7				
8				
9				
10				
11				
12				
13				
14				

To view the matrix as text, tap the cell (A6) and then [A].

	A	B	C	D
2	7	2	6	
3	3	6	9	
4				
5				
6	[[1,8,4],[7,2,6],[3,6,9]]			
7				

A6 Value:
 [[1,8,4],[7,2,6],[3,6,9]]
 A6 Formula:
 [[1,8,4],[7,2,6],[3,6,9]]

To view the matrix as 2D, tap [A] to change data types.

	A	B	C	D
2	7	2	6	
3	3	6	9	
4				
5				
6	[[1,8,4],[7,2,6],[3,6,9]]			
7				

A6 Value:



1	8	4
7	2	6
3	6	9

 A6 Formula:

1	8	4
7	2	6
3	6	9

Specifying Text or Calculation as the Data Type for a Particular Cell



A simple toolbar button operation lets you specify that the data contained in the currently selected cell or cells should be treated as either text or calculation data. The following shows how the specified data type affects how a calculation expression is handled when it is input into a cell.

When this data type is specified:	Inputting this into the cell:	Causes this to be displayed:
Text  (toolbar button for text)	=2+2	4
	2+2	2+2
Calculation  (toolbar button for math)	=2+2	4
	2+2	4

Important!

- Unless noted otherwise, all of the input examples in this chapter assume that input is being performed into a cell for which text is specified as the data type. Because of this, calculations that evaluate will be preceded with an equal sign (=).

• **ClassPad Operation**

- (1) Select the cell(s) whose data type you want to specify.
 - See “Selecting Cells” on page 13-3-5 for information about selecting cells.
- (2) On the toolbar, tap the third button from the left ( / ) to toggle the data type between text and calculation.



Using Drag and Drop to Copy Cell Data within a Spreadsheet

You can also copy data from one cell to another within a spreadsheet using drag and drop. If the destination cell already contains data, it is replaced with the newly dropped data.

- When performing this operation, you can drag and drop between cells, or from one location to another within the edit box only. You cannot drag and drop between cells and the edit box.

Important!

- Remember that moving cell data within a spreadsheet using drag and drop will cause all relative cell references in the data to be changed accordingly. See “Inputting a Cell Reference” on page 13-4-6 for more information.

• To drag and drop between cells within a spreadsheet

- (1) Use the stylus to select the cell or range of cells you want to copy so it is highlighted. Lift the stylus from the screen after you select the cell(s).
 - See “Selecting Cells” on page 13-3-5 for information about selecting cells.
- (2) Hold the stylus against the selected cell(s).

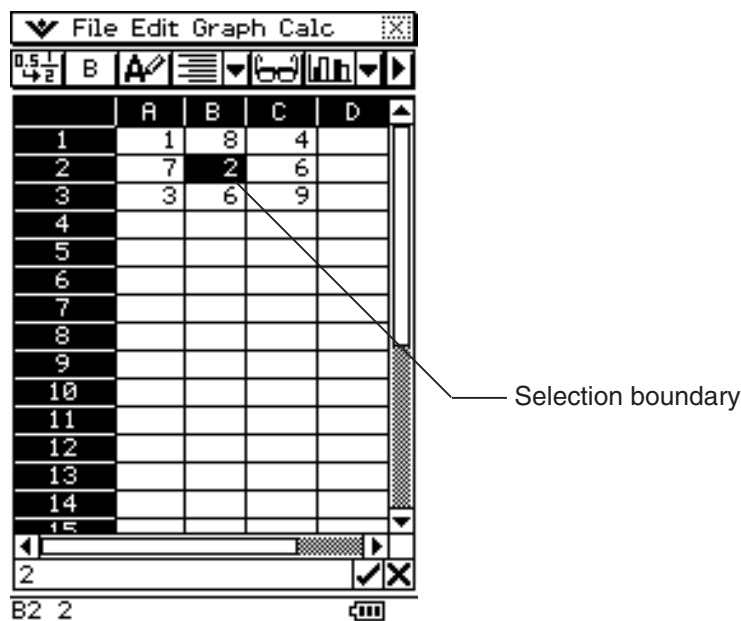

- Check to make sure that a white selection boundary appears where you hold the stylus against the screen.
 - If you have multiple cells selected (highlighted), the selection boundary will appear only around the single cell where the stylus is located. See “Dragging and Dropping Multiple Cells” on page 13-4-15 for more information.
- (3) Drag the stylus to the desired location and then lift the stylus to drop the cell(s) in place.

■ Dragging and Dropping Multiple Cells

- When dragging multiple cells, only the cell where the stylus is located has a selection boundary around it.

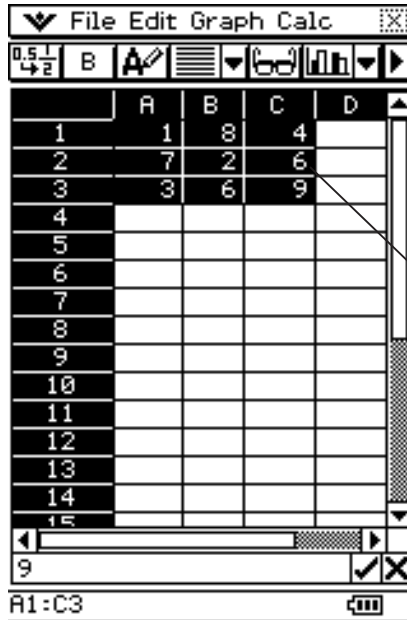

Selection boundary
(cursor held against C2)

- When you release the stylus from the screen, the top left cell of the group (originally A1 in the above example) will be located where you drop the selection boundary.

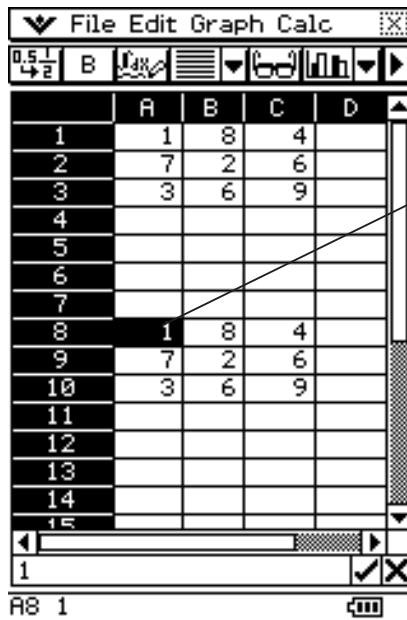

Selection boundary
dropped here (A8)

• **To drag and drop within the edit box**

- (1) Select the cell whose contents you want to edit.
- (2) Tap the edit box to enter the edit mode.
- (3) Tap the edit box again to display the editing cursor (a solid blinking cursor).
- (4) Drag the stylus across the characters you want to move, so they are highlighted.
- (5) Holding the stylus against the selected characters, drag to the desired location.
- (6) Lift the stylus to drop the characters in place.

Using Drag and Drop to Obtain Spreadsheet Graph Data

The following examples show how you can drag graph data from a Spreadsheet application Graph window to obtain the graph's function or the values of the graph's data.

• **To use drag and drop to obtain the function of a graph**

Example: To obtain the function of the regression graph shown below

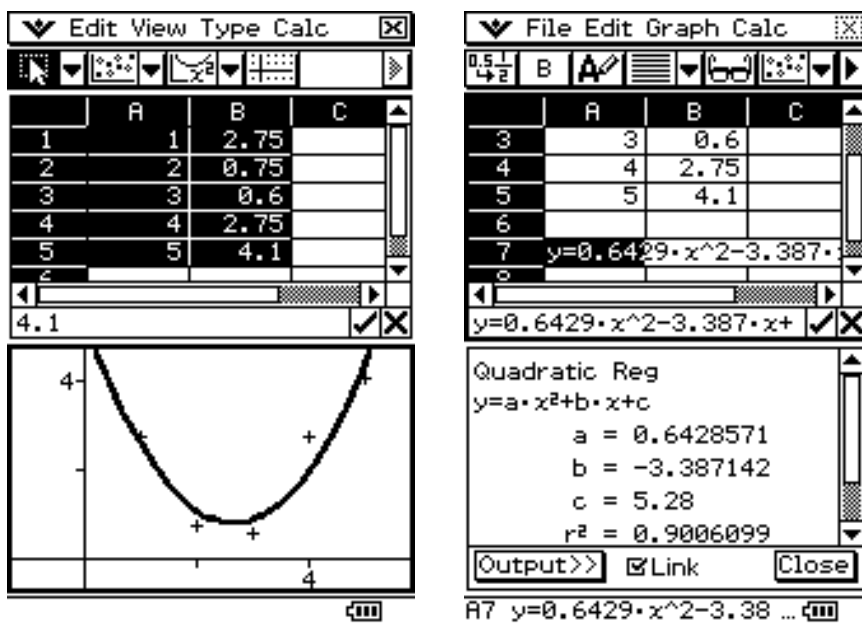

- (1) Input data and plot the scatter graph.
- (2) On the [Calc] menu, clear the check box next to [DispStat] by tapping it.
- (3) Draw a regression curve. For example, tap [Calc] and then [Quadratic Reg] here.
 - See “Regression Graph Operations” on page 13-9-15 for more information on drawing regression graph.
- (4) Tap the graph curve and then drag to the cell you want in the Spreadsheet window.
 - This will cause the graph's function to appear inside the cell.

• To use drag and drop to obtain the data points of a graph

Example: To obtain the data points of the bar graph shown below

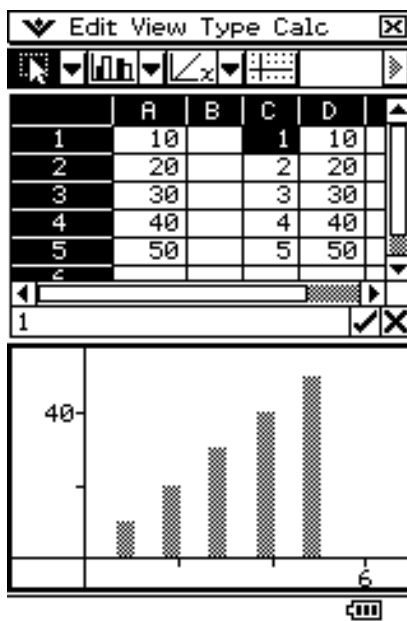

(1) Input data and draw a bar graph.

- See “Other Graph Window Operations” on page 13-9-16 for more information on graphing.

(2) Tap the Graph window to make it active.

(3) Tap the top of any bar within the Graph window, and then drag to the cell you want in the Spreadsheet window.

- This will cause the bar graph’s data to appear beginning at the cell you tapped.

Recalculating Spreadsheet Expressions

You can use the Recalculate command to recalculate the cells in a spreadsheet.

You should use Recalculate as described below.

- Let’s say there is a calculation expression (like $= a + 1$) that includes a variable input in a spreadsheet cell. When you assign a new value to the variable in the calculation expression (“ a ” in this example), the new value is not immediately reflected in calculation result that is displayed as the cell’s value. After assigning a value to a variable in a calculation expression, you need to execute the Recalculate command to update the calculation result.
- While the Spreadsheet application is being accessed from the Main application, changes you make to values assigned to variables on the Main application window are not reflected immediately on the Spreadsheet application window. In this case, you need to make the Spreadsheet application window active and execute the Recalculate command to update its contents.

Tip

- Recalculate is executed automatically whenever you switch to the Spreadsheet application from another application, and whenever you open a spreadsheet file.
- For information about accessing the Spreadsheet application or another application from the Main application, see “2-10 Using the Main Application in Combination with Other Applications.”

Example: To assign values to variables and recalculate expressions that contain them. The following procedure shows the recalculate operation while the Spreadsheet application is being accessed from the Main application.

• **ClassPad Operation**

(1) On the application menu, tap .

This starts the Main application and displays the work area.

(2) On the toolbar, tap the down arrow button next to .

This displays a palette of application icons.

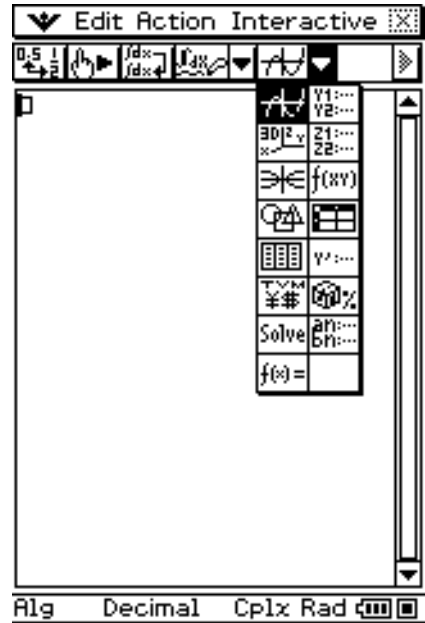

(3) Tap the  button.

This splits the display with a Main application window above and a Spreadsheet window below.

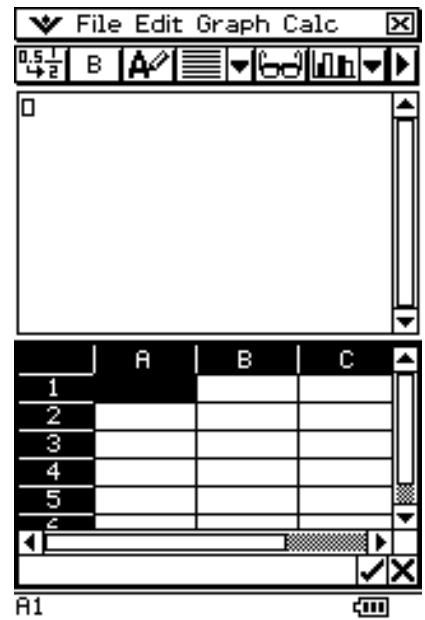

(4) On the Main application window, use the following operation to assign values to the variables.

math 1 2 3 \Rightarrow abc a EXE
math 4 5 6 \Rightarrow abc b EXE

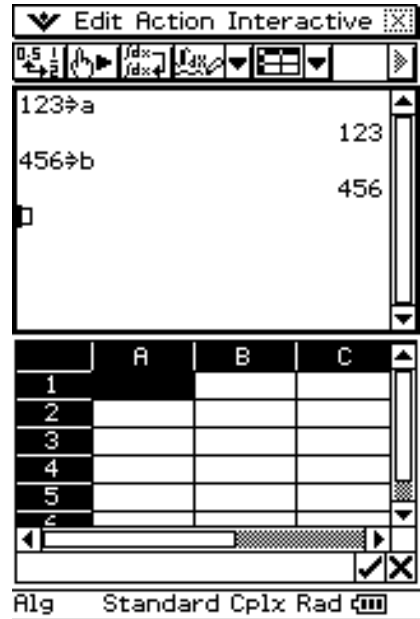

(5) On the Spreadsheet window, tap cell A1 and input =a+b. Next, tap cell A2 and input =axb.

When you input the above expressions, the results will appear dynamically in cells A1 and A2.

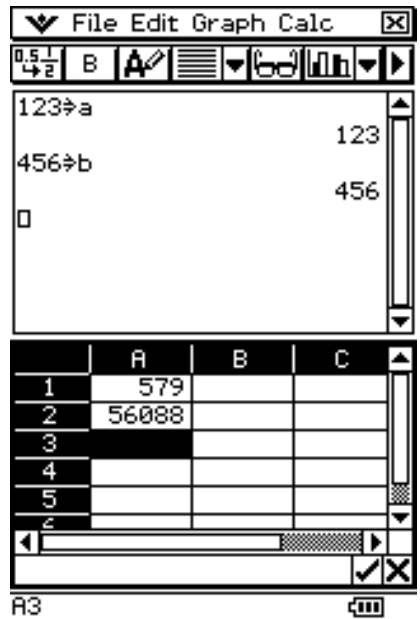

(6) On the Main application window, assign different values to the variables.

Here, assign 789 to variable b as shown below.

mth **7** **8** **9** **⇒** **abc** **b** **EXE**

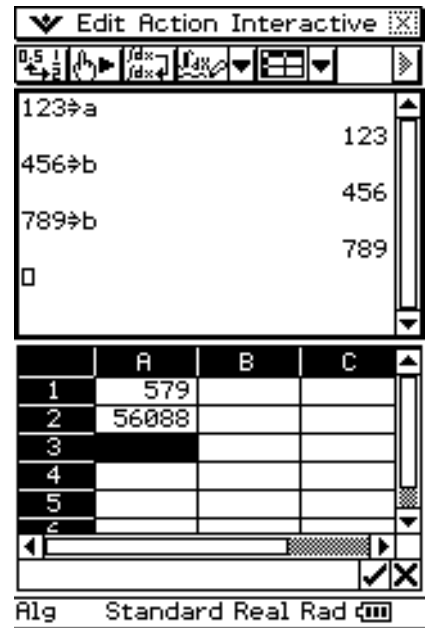

(7) Tap the Spreadsheet application window to make it active. On the [File] menu, tap [Recalculate].

This recalculates the expressions in the Spreadsheet window and displays their results.

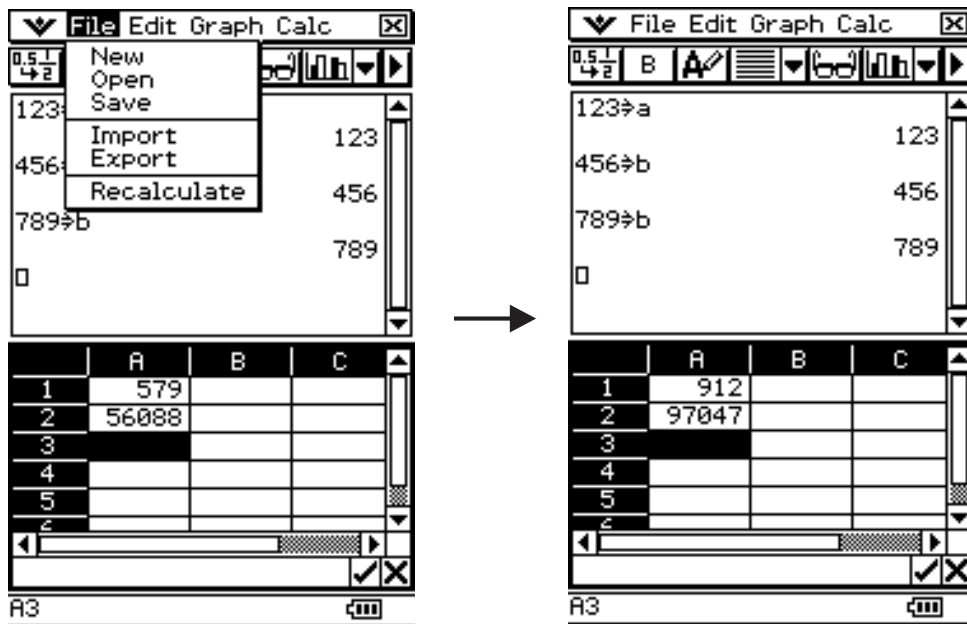

Importing and Exporting Variable Values

You can use the procedures in this section to import the data currently assigned to a variable into a spreadsheet, and to export data in a spreadsheet to a variable.

■ Importing data assigned to a variable into a spreadsheet

You can import the data assigned to a variable into a specific cell or a range of cells in the spreadsheet that is currently open on the ClassPad display. Import of variable data from the following data types is supported: LIST (list data), MAT (matrix data), EXPR (numeric or expression data), and STR (string data).

The procedures in this section assume that the variables (NData, LData, MData, SData) shown in the screen below are already present on the Main application.

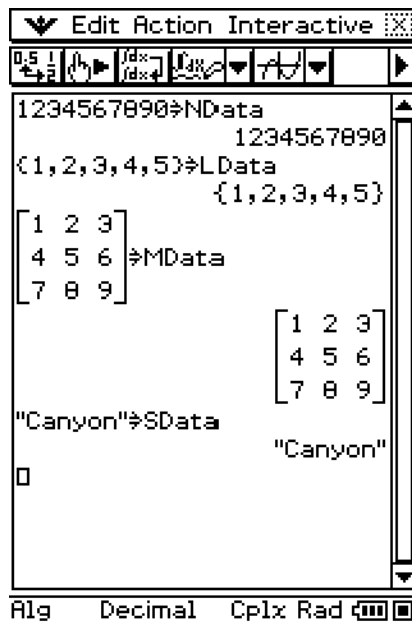

Tip

- For details about data types, see “Variable Data Types” on page 1-7-3.
- For details about creating variables, see “Creating a New Variable” on page 1-7-6.

● To import the data assigned to an EXPR variable

Example: To import the data assigned to the NData variable into cell A1

- (1) Tap cell A1 to select it.
- (2) On the [File] menu, tap [Import].

This displays the Import dialog box along with a soft keyboard.



- (3) Type the variable name (in this case “NData”) into the [Variable] box.

(4) After confirming that everything is the way you want, tap [OK].

- This will input the data assigned to the NData variable (in this case, 1234567890) into spreadsheet cell A1 as shown here.

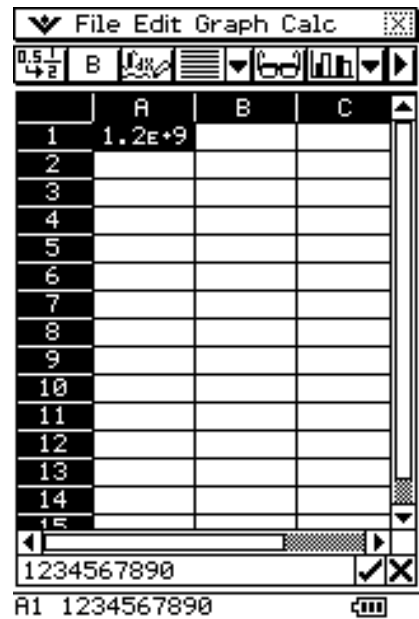

• **To import the data assigned to a LIST variable**

Example: To import the list data {1, 2, 3, 4, 5} assigned to the LData variable at cell A1

(1) Tap cell A1 to select it.

(2) On the [File] menu, tap [Import].

- This displays the Import dialog box along with a soft keyboard.



(3) Type the variable name (in this case "LData") into the [Variable] box.

(4) After confirming that everything is the way you want, tap [OK].

- This will input the data assigned to the LData variable (in this case, {1, 2, 3, 4, 5}) into spreadsheet cells A1 through A5 as shown here.

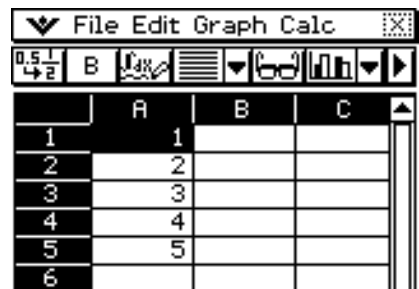

• **To import the data assigned to a MAT variable**

Example: To import the matrix data $\begin{bmatrix} 1 & 2 & 3 \\ 4 & 5 & 6 \\ 7 & 8 & 9 \end{bmatrix}$ assigned to the MData variable at cell A1

(1) Tap cell A1 to select it.

(2) On the [File] menu, tap [Import].

- This displays the Import dialog box along with a soft keyboard.

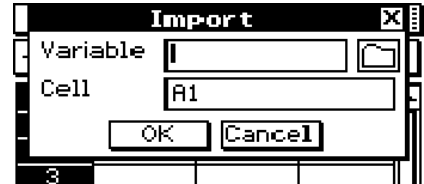

(3) Type the variable name (in this case “MData”) into the [Variable] box.

(4) After confirming that everything is the way you want, tap [OK].

- This will input the data assigned to the MData variable into the spreadsheet starting from cell A1 as shown here.

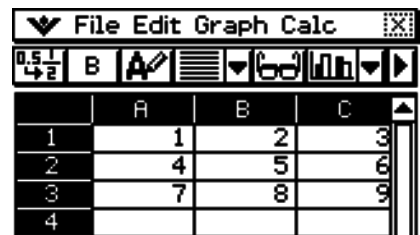

• **To import the data assigned to a STR variable**

Example: To import the data assigned to the SData variable into cell A1

(1) Tap cell A1 to select it.

(2) On the [File] menu, tap [Import].

- This displays the Import dialog box along with a soft keyboard.

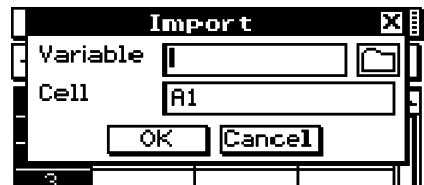



(3) Type the variable name (in this case “SData”) into the [Variable] box.

(4) After confirming that everything is the way you want, tap [OK].

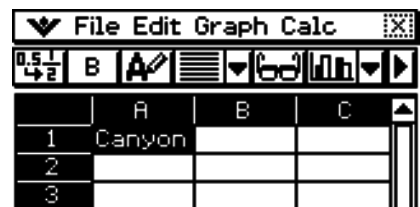
- This will input the data assigned to the SData variable into spreadsheet cell A1 as shown here.



Tip

- Tapping the  icon on the import dialog box will display the Variable Manager, which you can use to select the variable you want. See “1-8 Using the Variable Manager” for more information.
- The error message “Variable not found” will appear if the variable whose name you input on the Import dialog box cannot be found for some reason. If this happens, check to make sure that you input the variable name correctly and that the variable you specified is located in the current folder. If this does not correct the problem, tap the  icon on the Import dialog box and use the Variable Manager to select the variable you want. For information about the current folder, see “1-7 Variables and Folders”.

■ Exporting Spreadsheet Data to a Variable

You can use the procedures in this section to export the data contained in a specific cell or range of cells in the spreadsheet that is currently open on the ClassPad display. Export of spreadsheet data to the variables of the following data types is supported: LIST (list data), MAT (matrix data), and EXPR (numeric or expression data).

Tip

- For details about data types, see “Variable Data Types” on page 1-7-3.
- For information about using variables, see “1-7 Variables and Folders” and “1-8 Using the Variable Manager”.

● To export spreadsheet data to an EXPR variable

- (1) Select a single cell that contains the data you want to export to an EXPR variable.
 - You cannot export data from multiple cells to an EXPR variable. Be sure to select only one cell for this procedure.
 - It makes no difference whether the cell you select contains a value, expression, or string. Note that string data exported from a cell is exported as EXPR type data, not STR type data.
- (2) On the [File] menu, tap [Export].
 - This displays the Export dialog box along with a soft keyboard.
 - In this case, “EXPR” will be automatically selected in the [Type] box.



- (3) Type the variable name into the [Variable] box.
- (4) After confirming that everything is the way you want, tap [OK].

● To export spreadsheet data to a LIST variable

- (1) Select the range of cells that contains the data you want to export to a LIST variable.
- (2) On the [File] menu, tap [Export].
 - This displays the Export dialog box along with a soft keyboard.
- (3) Tap the [Type] box down arrow button, and then select “LIST” from the list of variable types that appears.
 - If the range of cells you selected in step 1 consists of columns in a single line or multiple lines in a single column, “LIST” will be selected as the variable type automatically.
- (4) Type the variable name into the [Variable] box.
- (5) After confirming that everything is the way you want, tap [OK].

• **To export spreadsheet data to a MAT (Matrix) variable**

- (1) Select the range of cells that contains the data you want to export to a Mat variable.
- (2) On the [File] menu, tap [Export].
This displays the Export dialog box along with a soft keyboard.
- (3) Tap the [Type] box down arrow button, and then select “MATRIX” from the list of variable types that appears.
 - If the range of cells you selected in step 1 consists of multiple columns and multiple lines, “MATRIX” will be selected as the variable type automatically.
- (4) Type the variable name into the [Variable] box.
- (5) After confirming that everything is the way you want, tap [OK].

Tip

- A confirmation dialog box like the one shown below will appear when you tap [OK] if the name in the [Variable] box on the Export dialog box is already being used by another variable.



To overwrite the existing variable with the new one, tap [OK]. If you do not want to overwrite the existing variable, tap [Cancel] to appear to the Export dialog box. Type a different name into the [Variable] box.

Searching for Data in a Spreadsheet

The Search command helps you locate specific data in a spreadsheet quickly and easily.

■ Search Dialog Box

The Search command can be executed either by tapping [Search] on the [Edit] menu or by tapping the  button on the toolbar. Executing the Search command displays a search dialog box like the one shown below, along with a soft keyboard.

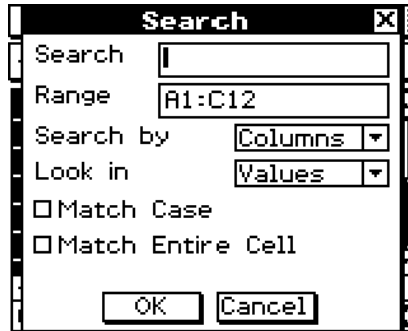

The following explains the meaning of each item on the search dialog box.

Item	Description												
Search	Enter the character string, value, or expression you want to search for. What you enter is called the “search string”.												
Range	Specifies the range of cells to be searched.												
Search by	Specifies whether the search should be line-by-line or column-by-column.												
Look in	Specifies whether values or formulas should be searched.												
<input type="checkbox"/> Match Case	Select this check box to find exact matches, including uppercase and lowercase characters, of what is specified in the [Search] box. Clear the checkbox to search for matches, regardless of case.												
<input type="checkbox"/> Match Entire Cell	<p>Select this check box to find cells that contain only what is specified in the [Search] box, and nothing else. Clear the check box to find cells that contain what is specified in the [Search] box, even if it is mixed with other data.</p> <p>The following table shows a number of examples of what happens for each of the [Match Entire Cell] settings when “bcd” is specified in the [Search] box. “○” indicates that the cell is a match, while “×” is not a match.</p> <table border="1"> <thead> <tr> <th>Cell Contents</th> <th>Not Selected</th> <th>Selected</th> </tr> </thead> <tbody> <tr> <td>abcdef</td> <td>○</td> <td>×</td> </tr> <tr> <td>bcd</td> <td>○</td> <td>○</td> </tr> <tr> <td>bcdef</td> <td>○</td> <td>×</td> </tr> </tbody> </table>	Cell Contents	Not Selected	Selected	abcdef	○	×	bcd	○	○	bcdef	○	×
Cell Contents	Not Selected	Selected											
abcdef	○	×											
bcd	○	○											
bcdef	○	×											

■ Search Examples

Example 1: To search for the letter “a”, regardless of case

● ClassPad Operation

(1) Display the spreadsheet you want to search.

- This example is based on a spreadsheet that contains the data shown below.

	A	B	C
1	a	g	m
2	b	h	n
3	c	AB	o
4	d	j	p
5	aa	k	ca
6	f	l	r
7			
8			

(2) Tap [Search] on the [Edit] menu or tap the toolbar button.

- This displays the Search dialog box.
- The initial default setting for the [Range] box is the range of cells that contains data (A1:C12 in this example).

Search

Search:

Range:

Search by:

Look in:

Match Case

Match Entire Cell

(3) Enter the search string in the [Search] box.

- Here we will enter “a”.
- Since we want to find the letter “a” regardless of case and since we do not care if there is other data in a cell, we will not select the [Match Case] and [Match Entire Cell] check boxes.

(4) After all the settings are the way you want, tap [OK].

- This will start the search and the cursor will jump to the first cell found that contains a match for the search string.

	A	B	C
1	a	g	m
2	b	h	n
3	c	AB	o
4	d	j	p
5	aa	k	ca
6	f	l	r
7			
8			

(5) To search for the next instance of the search string, tap [Search Again] on the [Edit] menu or tap the toolbar  button.

- Each time you tap the [Search Again] command or the  toolbar button, the search will jump to the next cell that contains the specified search string.

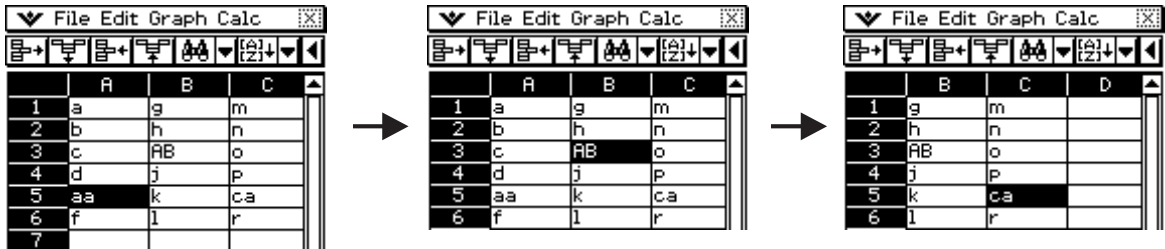

- The message “Search String not found in range.” will appear if the string you specified does not exist within the specified range of cells. Tap [OK] to clear the message from the screen.

Example 2: To search for calculation expressions that contain the string “+1”

In this example, we want the spreadsheet cells that contain a calculation expression (like $=1+2$) to show the expression, not the calculation result (3, for example). To do this, select “Formulas” for the [Look in] option on the Search dialog box.

• ClassPad Operation

(1) Display the spreadsheet you want to search.

- This example is based on a spreadsheet that contains the data shown below.

	A	B
1	$=a+2$	$=3+1$
2	$=b+1$	$=8+2$
3	$=C+2$	$=18+2$
4	$=d-3$	$=28+2$
5	$=e+1$	$=39+1$

Expressions in each cell

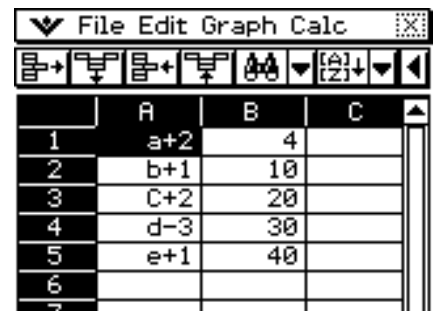

Displayed spreadsheet

(2) Tap [Search] on the [Edit] menu or tap the toolbar  button.

- This displays the Search dialog box.

(3) Configure the search dialog box settings as shown here.

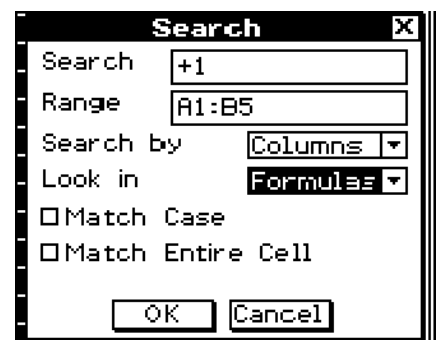

(4) Tap [OK].

- This will start the search and the cursor will jump to the first cell found that contains a match for the search string.

	A	B	C
1	a+2	4	
2	b+1	10	
3	C+2	20	
4	d-3	30	
5	e+1	40	
6			

(5) To search for the next instance of the search string, tap [Search Again] on the [Edit] menu or tap the toolbar button.

- Each time you tap the [Search Again] command or the toolbar button, the search will jump to the next cell that contains the specified search string.

	A	B	C
1	a+2	4	
2	b+1	10	
3	C+2	20	
4	d-3	30	
5	e+1	40	
6			



	A	B	C
1	a+2	4	
2	b+1	10	
3	C+2	20	
4	d-3	30	
5	e+1	40	
6			



	A	B	C
1	a+2	4	
2	b+1	10	
3	C+2	20	
4	d-3	30	
5	e+1	40	
6			

Sorting Spreadsheet Data

You can use the procedures in this section to sort spreadsheet data in either ascending or descending order.

• To sort spreadsheet data using the [Sort] menu command

(1) Select the range of cells that contains the data you want to sort.

	A	B	C
1	d	11	
2	b	12	
3	c	13	
4	a	15	
5	t	17	
6	y	19	
7	i	22	
8	o	25	
9			

(2) On the [Edit] menu, tap [Sort].

- This displays the Sort dialog box. The [Range] box will show the range of cells you selected in step 1.

Sort

Range:

Key Column:

Ascending

Descending

- (3) Tap the [Key Column] box down arrow button. On the list that appears, select the column you want the sort to be based upon.
- (4) Tap either [Ascending] (a, b, c...) or [Descending] (z, y, x...).
- (5) After confirming that everything is the way you want, tap [OK].

- This will execute the sort and rearrange the data based on the column you specified for [Key Column].

	A	B	C
1	a	15	
2	b	12	
3	c	13	
4	d	11	
5	i	22	
6	o	25	
7	t	17	
8	y	19	
9			

• **To sort using the sort toolbar button**

After selecting the range of cells, tap either the (ascending) or (descending) toolbar button to execute the sort without displaying a dialog box. In this case, the data is sorted using the leftmost column of the selected range as the key column.

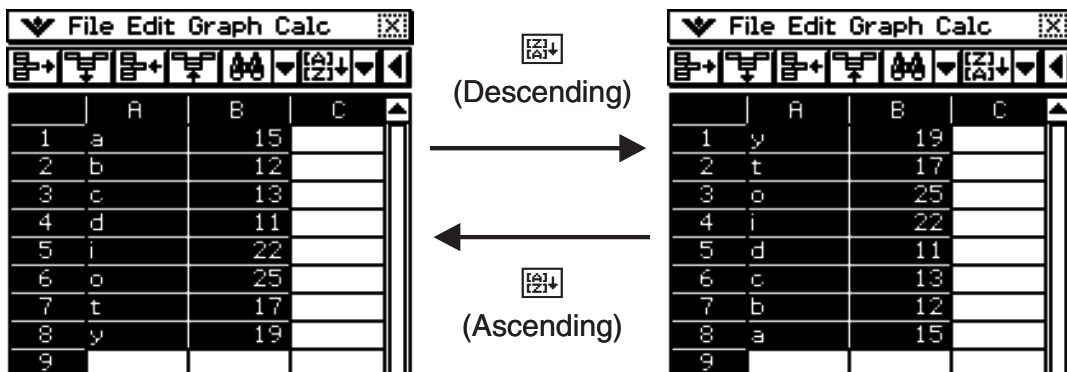

13-5 Using the Spreadsheet Application with the eActivity Application



You can display the Spreadsheet application from within the eActivity application. This makes it possible to drag data between the Spreadsheet and eActivity windows as desired.

Drag and Drop

After you open Spreadsheet within eActivity, you can drag and drop information between the two application windows.

Example 1: To drag the contents of a single cell from the Spreadsheet window to the eActivity window

• ClassPad Operation

- (1) Tap  to display the application menu, and then tap  to start the eActivity application.
- (2) From the eActivity application menu, tap [Insert] and [Strip], and then tap [Spreadsheet] on the submenu.
 - This inserts a Spreadsheet data strip, and displays the Spreadsheet window in the lower half of the screen.

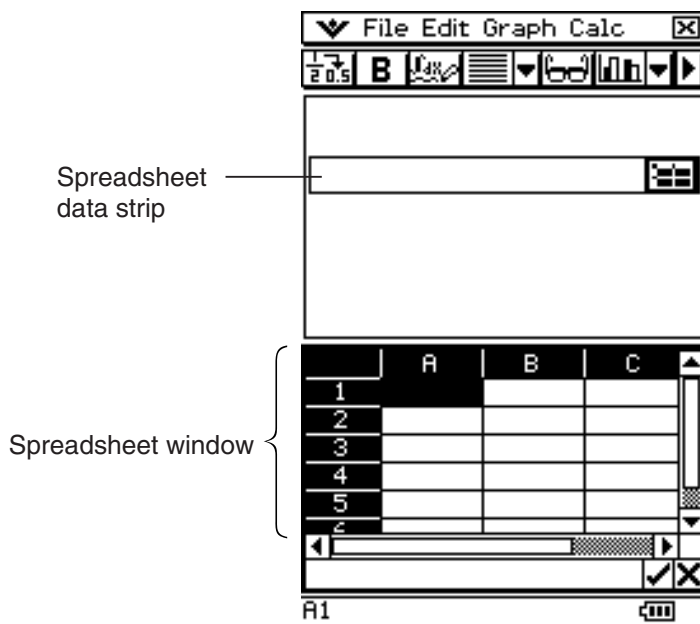

- Note that a Spreadsheet data strip works the same way as the Spreadsheet.
- (3) Input the text or value you want into the Spreadsheet window.

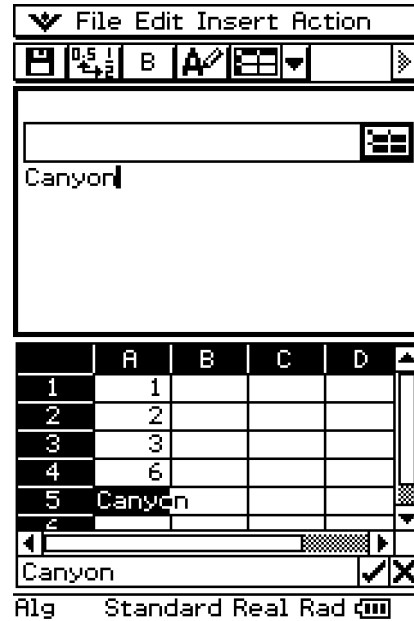
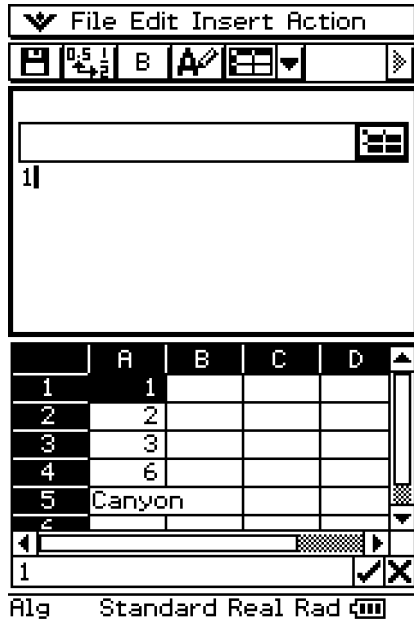

- (4) Select the cell you want and drag it to the first available line in the eActivity window.
- This inserts the contents of the cell in the eActivity window.
 - You can also select something in the edit box and drag it to the eActivity window. If you do, the edit box contents will become deselected after you drop them into the eActivity window.



- (5) You can now experiment with the data in the eActivity window.

Example 2: To drag a calculation expression from the Spreadsheet edit box to the eActivity window

• ClassPad Operation

- (1) Tap  to display the application menu, and then tap  to start the eActivity application.
- (2) From the eActivity application menu, tap [Insert] and [Strip], and then tap [Spreadsheet] on the submenu.
 - This inserts a Spreadsheet data strip, and displays the Spreadsheet window in the lower half of the screen.
- (3) Select a Spreadsheet cell and input the expression you want.
- (4) Tap the edit box to select (highlight) all of the contents of the edit box.



- (5) Drag the contents of the edit box to the first available line in the eActivity window.
- This inserts the contents of the edit box in the eActivity window as a text string.

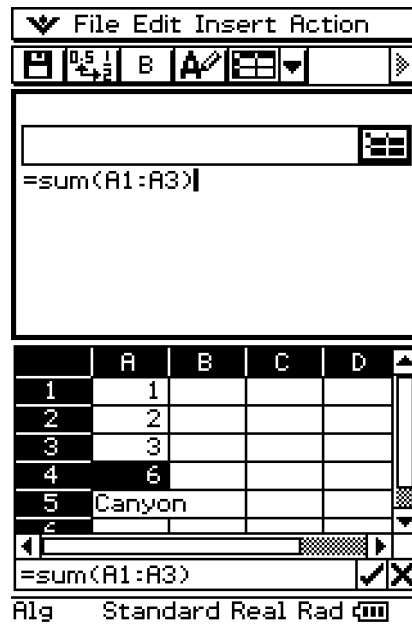

- (6) You can now experiment with the data in the eActivity window.
- The basic operations for the following example are the same for the other examples described above.

Example 3: Dragging multiple Spreadsheet cells to the eActivity window

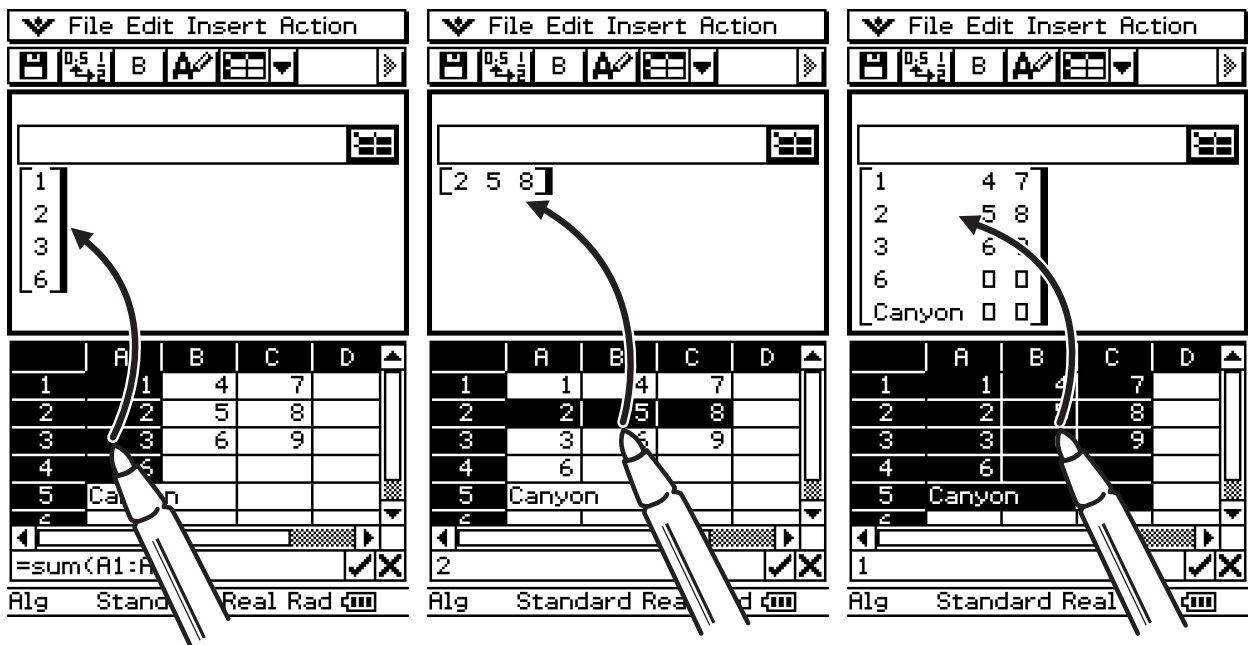

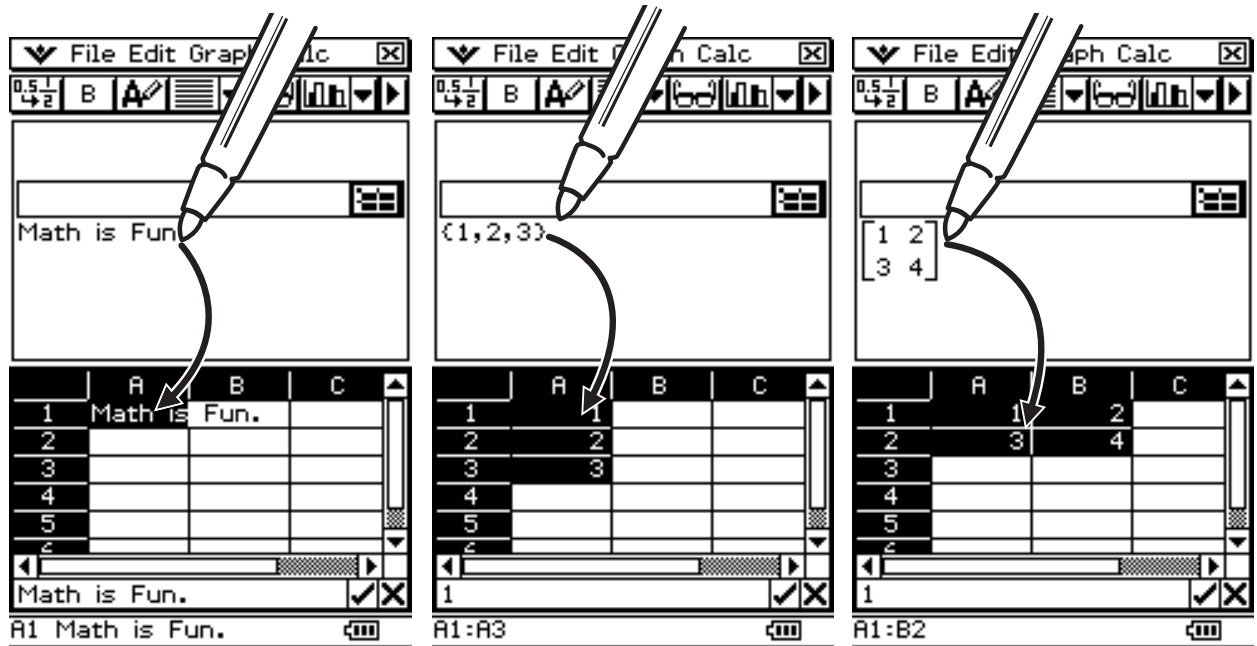
Example 4: Dragging data from eActivity to the Spreadsheet window

13-6 Statistical Calculations

The upper part of the [Calc] menu includes the same menu items as the Statistics Application [Calc] menu.

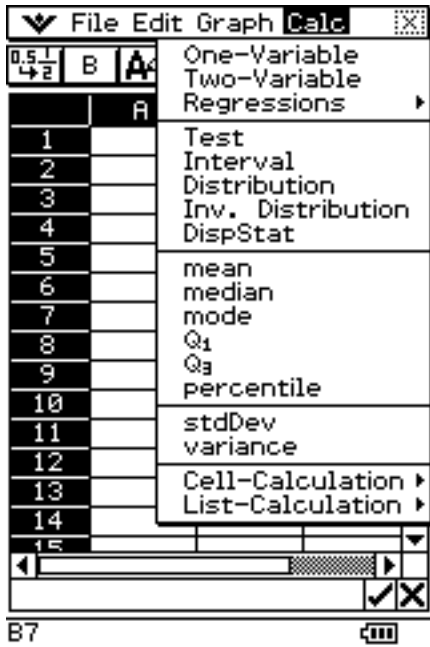

Spreadsheet Application

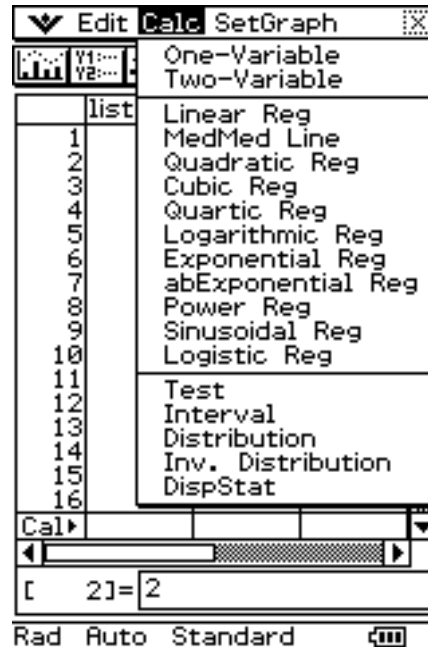

Statistics Application

Menu items with the same name perform the same functions, but there are some differences between the Statistics Application and Spreadsheet Application in terms of operation procedures, calculation result display, etc. This section explains statistical operations and functions that are peculiar to the Spreadsheet Application.

Tip

- For information about the Test, Interval, Distribution and DispStat commands, and the commands that appear on the One-Variable, Two-Variable and Regressions submenus, see “Chapter 7 Using the Statistics Application”.

■ Single-variable and Paired-variable Statistical Calculations

You can enter single-variable or paired-variable data into Spreadsheet cells and display a list of statistical values.

Single-variable
Data

X1
X2
X3
⋮

Frequencies for
Single-variable Data

X1	Freq 1
X2	Freq 2
X3	Freq 3
⋮	⋮

Paired-variable
Data

X1	Y1
X2	Y2
X3	Y3
⋮	⋮

Frequencies for
Paired-variable Data

X1	Y1	Freq 1
X2	Y2	Freq 2
X3	Y3	Freq 3
⋮	⋮	⋮

Example: To execute paired-variable calculations and display a list of statistical values

- (1) Enter the paired-variable data into the spreadsheet, and then select the range of cells where it is located.
- (2) On the menu bar, tap [Calc] and then [Two-Variable].
 - For details about the meaning of each value that appears as a statistical calculation result, see “Viewing Single-variable Statistical Calculation Results” (page 7-7-1) and “Viewing Paired-variable Statistical Calculation Results” (page 7-7-2).

■ Regression Calculations

You can use regression calculation to determine the regression formula that approximates paired-variable spreadsheet data. Regression calculations results are displayed as a list of coefficients for the regression model formula.

Tip

- For information about regression graphing, see “Regression Graph Operations” (page 13-9-15).

• To perform a regression calculation

- (1) Enter the paired-variable data into the spreadsheet, and then select the range of cells where it is located.
- (2) On the menu bar, tap [Calc] and then [Regression]. Next, on the submenu that appears, tap the desired regression type.
 - The regression calculation result window will appear in the lower half of the display.

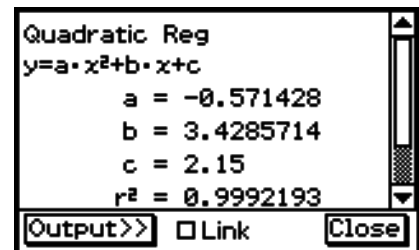

- For details about the model formula for the selected regression type and the meaning of each coefficient that appears, see pages 7-5-5 through 7-5-14 in “7-5 Graphing Paired-Variable Statistical Data”.

Tip

- Changing the range of data you selected in step (1) above and performing the regression calculation again will cause the regression calculation results displayed on the window to be updated automatically. You can disable automatic updating (if you feel that updating is taking too long or for any other reason) by clearing the Link check box on the regression calculation result window.

• **To paste a list of regression calculation results into a spreadsheet**

- (1) Perform the procedure under “To perform a regression calculation” and display the regression calculation result window.
- (2) On the regression calculation result window, tap the [Output>>] button.
- (3) On the output window, tap [Paste].

- This pastes a table of system variables to which regression calculation results are assigned and the results.

	C	D	E
1	a	-0.571	
2	b	3.4286	
3	c	2.15	
4	r ²	0.9992	
5	MSe	1.8E-3	

■ **Distribution Calculation**

You can use spreadsheet data to perform the same distribution calculations you can perform with the Statistics Application. For details about the different types of distribution calculations and the meanings of the variables that are displayed for calculation results, see “7-11 Distributions”.

• **To perform a distribution calculation**

- (1) Enter the single-variable or paired-variable data into the spreadsheet, and then select the range of cells where it is located.
 - The following shows the types of data that correspond to each type of distribution calculation, and the variables that will be assigned the range of selected data.

Distribution Type	Data	Variable Assignment
Probability Density	Single-variable	x
Cumulative Distribution	Paired-variable	Lower, Upper
Inverse Cumulative Distribution	Single-variable	$prob$

- (2) On the menu bar, tap [Calc] and then [Distribution].

- The Distribution Calculation Wizard will appear in the lower half of the display.

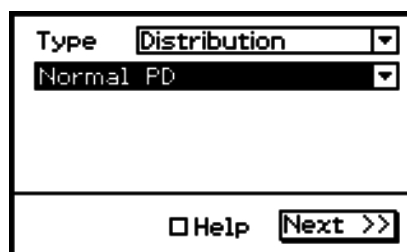

- (3) Tap the button to the right of the second item from the top and then select the desired distribution calculation from the menu that appears.

(4) Tap [Next >>].

- This will display a screen with the variable assignments for the range you selected in step 1 of this procedure entered automatically in the input fields as the initial defaults.

(5) Enter values for the other variables and then tap [Next >>].

- This displays the calculation results. If there are multiple calculation results, tap to view them.

(6) You can tap here to display the distribution graph.

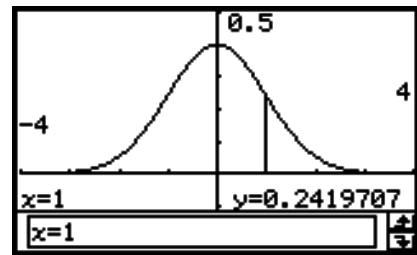

• **To paste distribution calculation results into a spreadsheet**

- Perform the procedure under “To perform a distribution calculation” and display the distribution calculation result window.
- On the calculation result window, tap the [Output>>] button.
- On the output window, tap [Paste].
 - This pastes the calculation results in formula format.

13-7 Cell and List Calculations

Use the [Calc] menu to perform cell and list calculations.

The [Calc] menu provides access to a [Cell-Calculation] submenu for cell calculations and a [List-Calculation] submenu for list calculations.

Spreadsheet [List-Calculation] Submenu Basics

The menu items on the [List-Calculation] submenu are the same as those on the [Action] - [List-Calculation] submenu of the Main Application. Menu items with the same name perform the same functions, but there are some differences between the Main Application and Spreadsheet Application in terms of operation procedures.

The following example demonstrates the basic procedure for using functions in the [List-Calculation] submenu.

Example: To calculate the sum of the following data, and then to add 100 to it

	A	B	C	D
1				
2				
3				
4				
5				
6				
7	61	12	33	
8	82	35	91	
9	47	57	57	
10	32	65	45	
11	46	45	54	
12	71	19	88	
13				
14				
15				

● **ClassPad Operation**

(1) With the stylus, tap the cell where you want the result to appear.

- In this example, we would tap cell A1.

(2) On the [Calc] menu, tap [List-Calculation] and then [sum] on the submenu.

- This inputs the sum function ([sum()]) into the edit box.

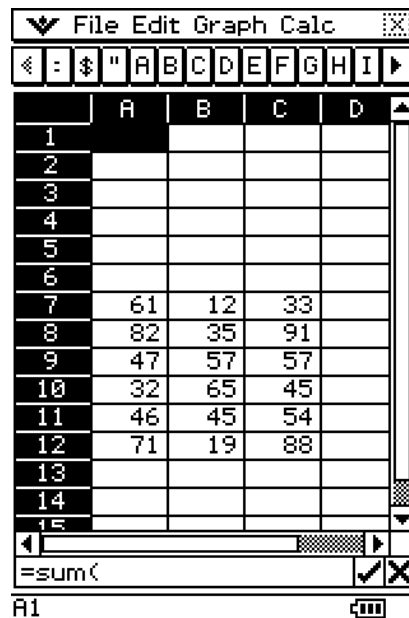

(3) Use the stylus to drag across the range of data cells from A7 to C12 to select them.

- "A7:C12" appears to the right of the open parenthesis of the [sum] function.

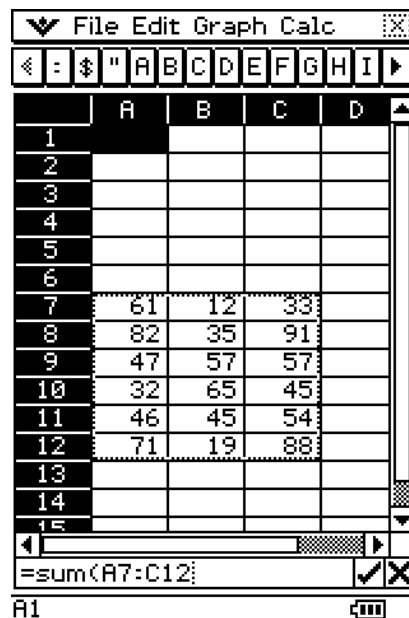

(4) Tap the button to the right of the edit box.

- This automatically closes the parentheses, calculates the sum of the values in the selected range, and displays the result in cell A1.
- You could skip this step and input the closing parentheses by pressing the Ⓢ key on the keypad, if you want.

File Edit Graph Calc				
	A	B	C	D
1	940			
2				
3				
4				
5				
6				
7	61	12	33	
8	82	35	91	
9	47	57	57	
10	32	65	45	
11	46	45	54	
12	71	19	88	
13				
14				
15				

=sum(A7:C12)

A1 940

(5) Tap the edit box to activate it again, and then tap to the right of the last parenthesis.

(6) Press the ⊕ key and then input 100.

(7) Tap the button to the right of the edit box.

- This calculates the result and displays it in cell A1.

File Edit Graph Calc				
	A	B	C	D
1	1040			
2				
3				
4				
5				
6				
7	61	12	33	
8	82	35	91	
9	47	57	57	
10	32	65	45	
11	46	45	54	
12	71	19	88	
13				
14				
15				

=sum(A7:C12)+100

A1 1040

Cell Calculation and List Calculation Functions

This section provides explanations of the functions, input syntax, and examples for each of the cell calculation and list calculation functions included on the [Calc] menu. Please note that “start cell:end cell” is equivalent to entering a list.

• Cell-Calculation - row

Function: Returns the row number of a specified cell.

Syntax: row(cell)

Example: To determine the row number of cell A7 and input the result in cell A1:

	A	B	C	D
1	7			
2				
3				
4				
5				
6				
7	61	12	33	
8	83	35	91	
9	47	57	57	
10	32	65	45	
11	46	45	21	
12	71	19	88	
13				
14				
15				

Formula bar: =row(A7)

Result: A1 7

• Cell-Calculation - col

Function: Returns the column number of a specified cell.

Syntax: col(cell)

Example: To determine the column number of cell C9 and input the result in cell A1:

	A	B	C	D
1	3			
2				
3				
4				
5				
6				
7	61	12	33	
8	83	35	91	
9	47	57	57	
10	32	65	45	
11	46	45	21	
12	71	19	88	
13				
14				
15				

Formula bar: =col(C9)

Result: A1 3

- **Cell-Calculation - count**

Function: Returns a count of the number of cells in the specified range.

Syntax: count(start cell[:end cell])

Example: To count the number of cells in the block whose upper left corner is located at A7 and whose lower right corner is located at C12, and input the result in cell A1:

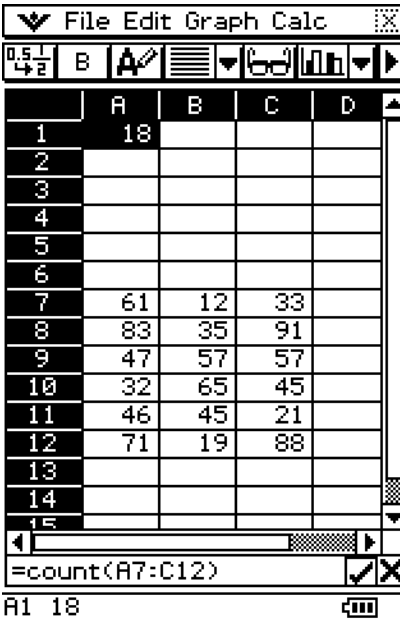

The screenshot shows a handheld calculator interface with a spreadsheet grid. The grid has columns labeled A, B, C, and D, and rows numbered 1 through 15. The formula bar at the bottom displays the formula `=count(A7:C12)`. The result of the calculation, 18, is shown in cell A1.

	A	B	C	D
1	18			
2				
3				
4				
5				
6				
7	61	12	33	
8	83	35	91	
9	47	57	57	
10	32	65	45	
11	46	45	21	
12	71	19	88	
13				
14				
15				

Formula Bar: `=count(A7:C12)`

Status Bar: A1 18



- **Cell-Calculation - cellif**

Function: Evaluates an equality or inequality, and returns one of three different expressions based on whether the equality/inequality is true (expression 1), false (expression 2), or inconclusive (expression 3).

With this function, the equality/inequality can include a string as in the following example: `cellif(A1="Red", 0,1,2)`.

Syntax: `cellif(equation, expression 1, expression 2, expression 3)`

`cellif(inequality, expression 1, expression 2, expression 3)`

Example: For each value in cells A1 through A10, to display "Big" in the neighboring B-column cell for values of 5 and greater, and "Small" for values less than 5:

	A	B	C
1	0	Small	
2	1	Small	
3	2	Small	
4	3	Small	
5	4	Small	
6	5	Big	
7	6	Big	
8	7	Big	
9	8	Big	
10	9	Big	
11			
12			
13			
14			
15			

Formula bar: `=cellif(A1≥5, "Big", "Small")`

Status bar: B1 Small

`(=cellif(A1≥5, "Big", "Small"))`

- Expression 3 is optional for both equation and inequality.



- **List-Calculation - min**

Function: Returns the lowest value contained in the range of specified cells.

Syntax: `min(start cell[:end cell][,start cell[:end cell]]/ [,value])`

Example: To determine the lowest value in the block whose upper left corner is located at A7 and whose lower right corner is located at C12, and input the result in cell A1:

	A	B	C	D
1	12			
2				
3				
4				
5				
6				
7	61	12	33	
8	83	35	91	
9	47	57	57	
10	32	65	45	
11	46	45	21	
12	71	19	88	
13				
14				
15				

Formula bar: `=min(A7:C12)`

Cell A1: 12

- **List-Calculation - max**

Function: Returns the greatest value contained in the range of specified cells.

Syntax: `max(start cell[:end cell][,start cell[:end cell]]/ [,value])`

Example: To determine the greatest value in the block whose upper left corner is located at A7 and whose lower right corner is located at C12, and input the result in cell A1:

	A	B	C	D
1	91			
2				
3				
4				
5				
6				
7	61	12	33	
8	83	35	91	
9	47	57	57	
10	32	65	45	
11	46	45	21	
12	71	19	88	
13				
14				
15				

Formula bar: `=max(A7:C12)`

Cell A1: 91

- **mean**

Function: Returns the mean of the values contained in the range of specified cells.

Syntax: `mean(start cell:end cell[,start cell:end cell])`

Example: To determine the mean of the values in the block whose upper left corner is located at A7 and whose lower right corner is located at C12, and input the result in cell A1:

	A	B	C	D
1	50.4			
2				
3				
4				
5				
6				
7	61	12	33	
8	83	35	91	
9	47	57	57	
10	32	65	45	
11	46	45	21	
12	71	19	88	
13				
14				
15				

Formula bar: `=mean(A7:C12)`

Cell A1: 50.44444444

- **median**

Function: Returns the median of the values contained in the range of specified cells.

Syntax: `median(start cell:end cell[,start cell:end cell])`

Example: To determine the median of the values in the block whose upper left corner is located at A7 and whose lower right corner is located at C12, and input the result in cell A1:

	A	B	C	D
1	46.5			
2				
3				
4				
5				
6				
7	61	12	33	
8	83	35	91	
9	47	57	57	
10	32	65	45	
11	46	45	21	
12	71	19	88	
13				
14				
15				

Formula bar: `=median(A7:C12)`

Cell A1: 46.5

- **mode**

Function: Returns the mode of the values contained in the range of specified cells.

Syntax: `mode(start cell:end cell[,start cell:end cell])`

Example: To determine the mode of the values in the block whose upper left corner is located at A7 and whose lower right corner is located at C12, and input the result in cell A1:

	A	B	C
1	11		
2			
3			
4			
5			
6			
7	10	12	17
8	10	12	17
9	11	13	18
10	11	14	19
11	11	15	20
12	11	16	20
13			
14			
15			

Formula bar: `=mode(A7:C12)`

Result: A1 11

- **Q₁**

Function: Returns the first quartile of the values contained in the range of specified cells.

Syntax: `Q1(start cell:end cell[,start cell:end cell])`

Example: To determine the first quartile of the values in the block whose upper left corner is located at A7 and whose lower right corner is located at C12, and input the result in cell A1:

	A	B	C	D
1	33			
2				
3				
4				
5				
6				
7	61	12	33	
8	83	35	91	
9	47	57	57	
10	32	65	45	
11	46	45	21	
12	71	19	88	
13				
14				
15				

Formula bar: `=Q1(A7:C12)`

Result: A1 33

- **Q₃**

Function: Returns the third quartile of the values contained in the range of specified cells.

Syntax: $Q_3(\text{start cell}:\text{end cell}[, \text{start cell}:\text{end cell}])$

Example: To determine the third quartile of the values in the block whose upper left corner is located at A7 and whose lower right corner is located at C12, and input the result in cell A1:

	A	B	C	D
1	65			
2				
3				
4				
5				
6				
7	61	12	33	
8	83	35	91	
9	47	57	57	
10	32	65	45	
11	46	45	21	
12	71	19	88	
13				
14				
15				

Formula bar: $=Q_3(A7:C12)$

Result: A1 65

- **percentile**

Function: Returns the n th percentile in the range of specified cells.

Syntax: $\text{percentile}(\text{start cell}[:\text{end cell}], \text{value})$

Example: To determine the 50th percentile of the values in cells A7 through A12 and input the result in cell A1:

	A	B	C	D
1	54			
2				
3				
4				
5				
6				
7	61	12	33	
8	83	35	91	
9	47	57	57	
10	32	65	45	
11	46	45	21	
12	71	19	88	
13				
14				
15				

Formula bar: $=\text{percentile}(A7:A12, 50)$

Result: A1 54

- **stdDev**

Function: Returns the sample standard deviation of the values contained in the range of specified cells.

Syntax: stdDev(start cell:end cell)

Example: To determine the sample standard deviation of the values in the block whose upper left corner is located at A7 and whose lower right corner is located at C12, and input the result in cell A1:

	A	B	C	D
1	23.3			
2				
3				
4				
5				
6				
7	61	12	33	
8	83	35	91	
9	47	57	57	
10	32	65	45	
11	46	45	21	
12	71	19	88	
13				
14				
15				

Formula bar: =stdDev(A7:C12)

Cell A1: 23.33193273

- **variance**

Function: Returns the sample variance of the values contained in the range of specified cells.

Syntax: variance(start cell:end cell)

Example: To determine the sample variance of the values in the block whose upper left corner is located at A7 and whose lower right corner is located at C12, and input the result in cell A1:

	A	B	C	D
1	544.			
2				
3				
4				
5				
6				
7	61	12	33	
8	83	35	91	
9	47	57	57	
10	32	65	45	
11	46	45	21	
12	71	19	88	
13				
14				
15				

Formula bar: =variance(A7:C12)

Cell A1: 544.379085

- **List-Calculation - sum**

Function: Returns the sum of the values contained in the range of specified cells.

Syntax: `sum(start cell:end cell[,start cell:end cell])`

Example: To determine the sum of the values in the block whose upper left corner is located at A7 and whose lower right corner is located at C12, and input the result in cell A1:

	A	B	C	D
1	908			
2				
3				
4				
5				
6				
7	61	12	33	
8	83	35	91	
9	47	57	57	
10	32	65	45	
11	46	45	21	
12	71	19	88	
13				
14				
15				

Formula bar: `=sum(A7:C12)`

Status bar: A1 908

- **List-Calculation - prod**

Function: Returns the product of the values contained in the range of specified cells.

Syntax: `prod(start cell:end cell[,start cell:end cell])`

Example: To determine the product of the values in cells A7 and A8, and input the result in cell A1:

	A	B	C	D
1	5561			
2				
3				
4				
5				
6				
7	67			
8	83			
9	47			
10	32			
11	46			
12	71			
13				
14				
15				

Formula bar: `=prod(A7:A8)`

Status bar: A1 5561

- **List-Calculation - cuml**

Function: Returns the cumulative sums of the values contained in the range of specified cells.

Syntax: `cuml(start cell:end cell)`

Example: To determine the cumulative sums of the values in cells B1 through B3, and input the result in cell A1:

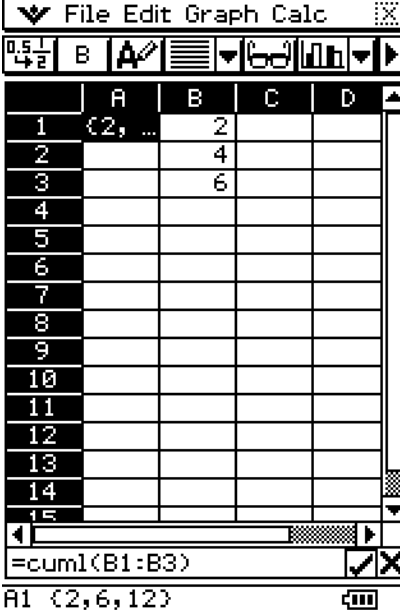

	A	B	C	D
1	=cuml(B1:B3)	2		
2		4		
3		6		
4				
5				
6				
7				
8				
9				
10				
11				
12				
13				
14				
15				

Formula bar: =cuml(B1:B3)

Status bar: A1 (2,6,12)

- **List-Calculation - Δlist**

Function: Returns the differences between values in each of the adjacent cells in the range of specified cells.

Syntax: `Δlist(start cell:end cell)`

Example: To determine the differences of the values in cells B1 through B3, and input the result in cell A1:

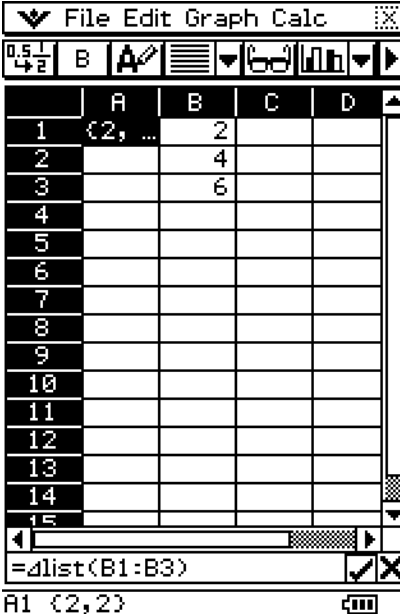

	A	B	C	D
1	=Δlist(B1:B3)	2		
2		4		
3		6		
4				
5				
6				
7				
8				
9				
10				
11				
12				
13				
14				
15				

Formula bar: =Δlist(B1:B3)

Status bar: A1 (2,2)

- **List-Calculation - percent**

Function: Returns the percentage of each value in the range of specified cells, the sum of which is 100%.

Syntax: percent(start cell:end cell)

Example: To determine the percentage of the values in cells B1 through B4, and input the result in cell A1:

	A	B	C	D
1	(10 ...	2		
2		8		
3		6		
4		4		
5				
6				
7				
8				
9				
10				
11				
12				
13				
14				
15				

Formula Bar: =percent(B1:B4)

Result: A1 (10,40,30,20)

- **List-Calculation - polyEval**

Function: Returns a polynomial arranged in descending order. The coefficients correspond sequentially to each value in the range of specified cells.

Syntax: polyEval(start cell:end cell[,start cell:end cell]/ [,variable])

Example: To create a second degree polynomial with coefficients that correspond to the values in cells B1 through B3, and input the result in cell A1:

	A	B	C	D
1	2·x ...	2		
2		8		
3		6		
4				
5				
6				
7				
8				
9				
10				
11				
12				
13				
14				
15				

Formula Bar: =polyEval(B1:B3)

Result: A1 2·x^2+8·x+6

- “x” is the default variable when you do not specify one above.
- To specify “y” as the variable, for example, enter “=polyEval(B1:B3, y)”.

- **List-Calculation - sequence**

Function: Returns the lowest-degree polynomial that generates the sequence expressed by the values in a list or range of specified cells. If we evaluate the polynomial at 2, for example, the result will be the second value in our list.

Syntax: `sequence(start cell:end cell[,start cell:end cell][,variable])`

Example: To determine a polynomial for the sequence values in cells B1 through B4 and a variable of “y”, and input the result in cell A1:

	A	B	C	D
1	1.3 ...	2		
2		8		
3		6		
4		4		
5				
6				
7				
8				
9				
10				
11				
12				
13				
14				
15				

Formula Editor: `=sequence(B1:B4,y)`

Result: `A1 1.333333333·y^3-1 ...`

- “x” is the default variable when you do not specify one above.



- **List-Calculation - sumSeq**

Function: Determines the lowest-degree polynomial that generates the sum of the first n terms of your sequence. If we evaluate the resulting polynomial at 1, for example, the result will be the first value in your list. If we evaluate the resulting polynomial at 2, the result will be the sum of the first two values in your list.

When two columns of values or two lists are specified, the resulting polynomial returns a sum based on a sequence.

Syntax: `sumSeq(start cell:end cell[,start cell:end cell][,variable])`

Example: To determine a polynomial that generates the sum of the first n terms for the sequence expressed by the values in cells B1 through B4 with a variable of "y", and input the result in cell A1:

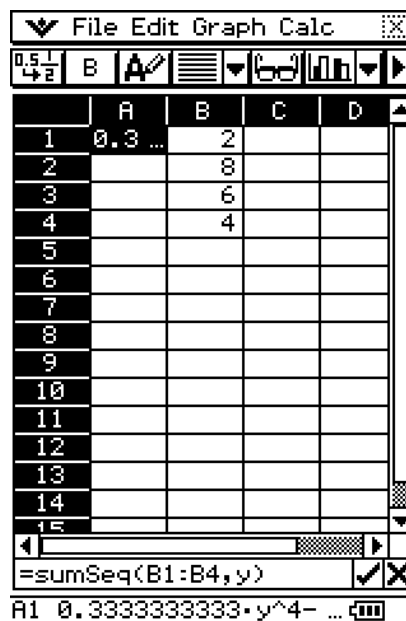

	A	B	C	D
1	0.3 ...	2		
2		8		
3		6		
4		4		
5				
6				
7				
8				
9				
10				
11				
12				
13				
14				
15				

Calculator display: `=sumSeq(B1:B4,y)`

Result in A1: `0.3333333333 * y^4 - ...`

- "x" is the default variable when you do not specify one above.





13-8 Formatting Cells and Data

This section explains how to control the format of the spreadsheet and the data contained in the cells.

Standard (Fractional) and Decimal (Approximate) Modes

You can use the following procedure to control whether a specific cell, row, or column, or the entire spreadsheet should use the standard mode (fractional format) or decimal mode (approximate value).



• ClassPad Operation

- (1) Select the cell(s) whose format you want to specify.
 - See “Selecting Cells” on page 13-3-5 for information about selecting cells.
- (2) On the toolbar, tap the left button ( / ) to toggle between the standard mode and the decimal mode.

Plain Text and Bold Text

Use the following procedure to toggle the text of a specific cell, row, or column, or the entire spreadsheet between plain and bold.



• ClassPad Operation

- (1) Select the cell(s) whose text setting you want to specify.
 - See “Selecting Cells” on page 13-3-5 for information about selecting cells.
- (2) On the toolbar, tap the  /  button to toggle between bold and plain text.

Text and Calculation Data Types

Make use of the following procedure to toggle a specific cell, row, or column, or the entire spreadsheet for either text or calculation data types.

• ClassPad Operation

- (1) Select the cell(s) whose format you want to specify.
 - See “Selecting Cells” on page 13-3-5 for information about selecting cells.
- (2) On the toolbar, tap the  /  button to toggle between Text Input mode and Calculation Input mode.







Text Alignment

With the following procedure, you can specify justified, align left, center, or align right for a specific cell, row, or column, or the entire spreadsheet.

• ClassPad Operation

- (1) Select the cell(s) whose alignment setting you want to specify.
 - See “Selecting Cells” on page 13-3-5 for information about selecting cells.
- (2) On the toolbar, tap the down arrow button next to the  button.
- (3) On the button menu that appears, tap the text alignment option you want to use.

For this type of alignment:	Tap this option:
Left and right justified	
Left	
Center	
Right	

Number Format

Use the following procedure to specify the number format (Normal 1, Normal 2, Fix 0 – 9, Sci 0 – 9) of a specific cell, row, or column, or the entire spreadsheet.

• ClassPad Operation

- (1) Select the cell(s) whose number format setting you want to specify.
 - See “Selecting Cells” on page 13-3-5 for information about selecting cells.
- (2) On the [Edit] menu, tap [Number Format].

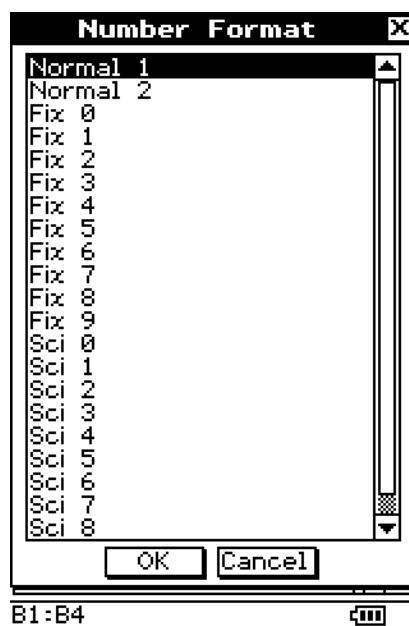

- (3) On the dialog box that appears, select the number format you want to use.
- (4) Tap [OK].

Changing the Width of a Column

There are three different methods you can use to control the width of a column: dragging with the stylus, using the [Column Width] command, or using the [AutoFit Selection] command.

- **To change the width of a column using the stylus**

Use the stylus to drag the edge of a column header left or right until it is the desired width.

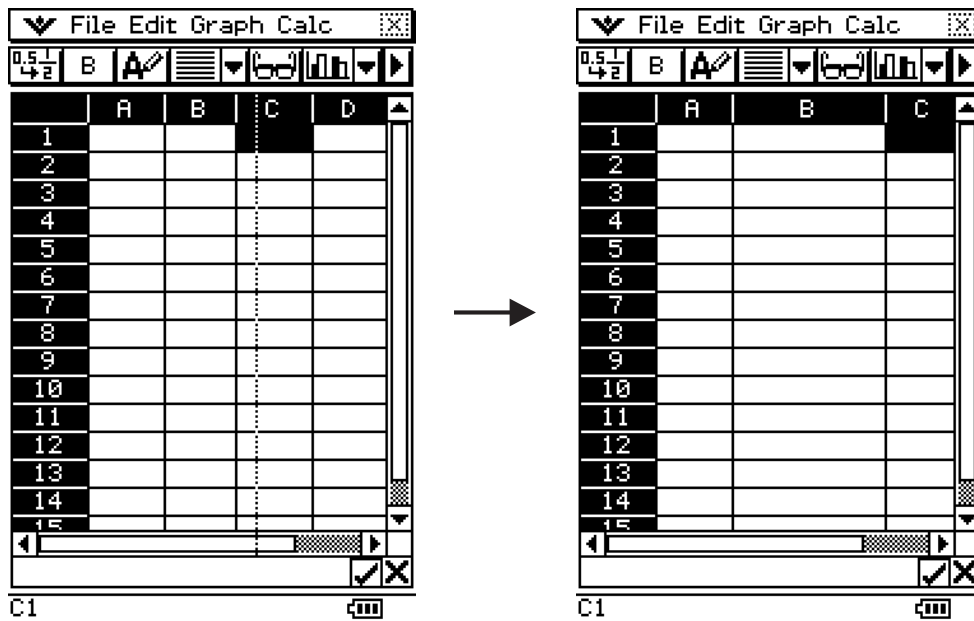

- **To change the width of a column using the Column Width command**

(1) Tap any cell in the column whose width you want to change.

- You could also drag the stylus to select multiple columns, if you want.

(2) On the [Edit] menu, tap [Column Width].



- (3) On the dialog box that appears, enter a value in the [Width] box to specify the desired width of the column in pixels.
- You can also use the [Range] box to specify a different column from the one you selected in step (1) above, or a range of columns. Entering B1:D1 in the [Range] box, for example, will change columns B, C, and D to the width you specify.
- (4) After everything is the way you want, tap [OK] to change the column width.

• To change the width of a column using the AutoFit Selection command

Example: To use [AutoFit Selection] to adjust the column width to display the value 1234567890

- (1) Tap a cell and input the value.

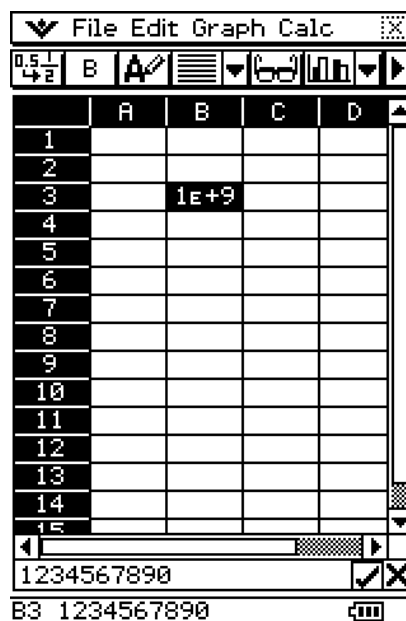

- Since the value is too long to fit in the cell, it is converted automatically to exponential format. Notice, however, that the entire value appears in the edit box.
- (2) Select the cell you want to auto fit.
- You can also select a range of cells in the same column or an entire column. In this case, the column width is adjusted to fit the largest data value in the column.
 - You can also select a range of cells or an entire row. In this case, each column width is adjusted to fit the largest data in its column.

13-8-5
Formatting Cells and Data

(3) On the [Edit] menu, tap [AutoFit Selection].

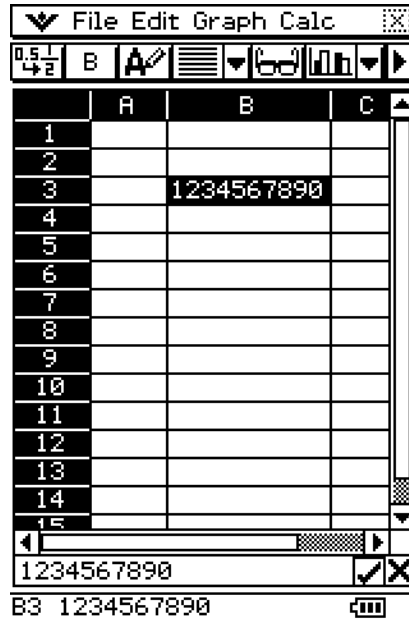

- This causes the column width to be adjusted automatically so the entire value can be displayed.
- Note that [AutoFit Selection] also will reduce the width of a column, if applicable. The following shows what happens when [AutoFit Selection] is executed while a cell that contains a single digit is selected.

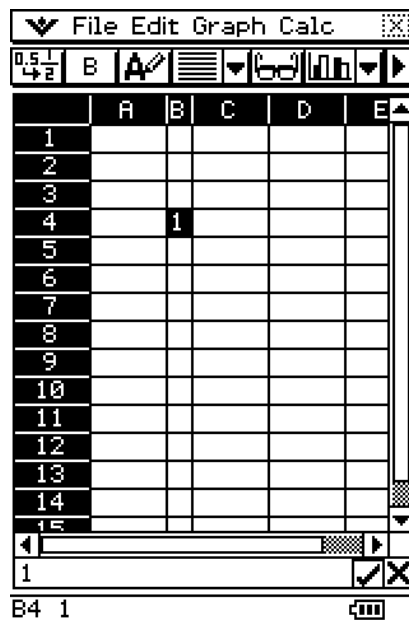

13-9 Graphing

The Spreadsheet application lets you draw a variety of different graphs for analyzing data. You can combine line and column graphs, and the interactive editing feature lets you change a graph by dragging its points on the display.

Graph Menu

After selecting data on the spreadsheet, use the [Graph] menu to select the type of graph you want to draw. You can also use the [Graph] menu to specify whether to graph data by column or row.

The following explains each of the [Graph] menu commands, and shows examples of what happens to the Graph window when you execute a command.

Note

- The following examples show the appearance of graph screens after tapping  on the icon panel so the Graph window fills the entire screen.
- Each command is followed by a button in parentheses to show the graph toolbar button that performs the same action as the command.



- [Graph] - [Line] - [Clustered] ()

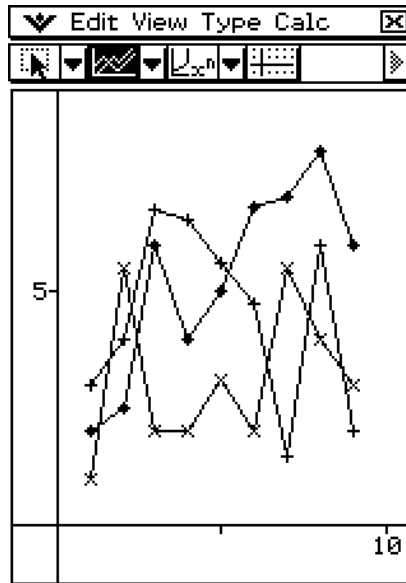

- [Graph] - [Line] - [Stacked] ()

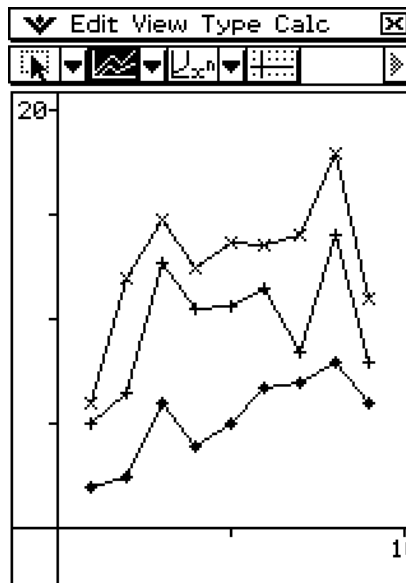

- [Graph] - [Line] - [100% Stacked] ()

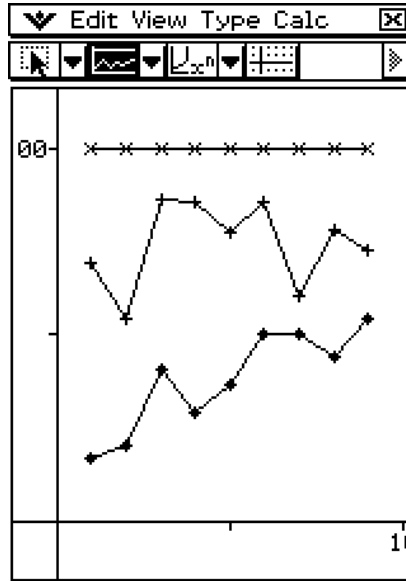

- [Graph] - [Column] - [Clustered] ()

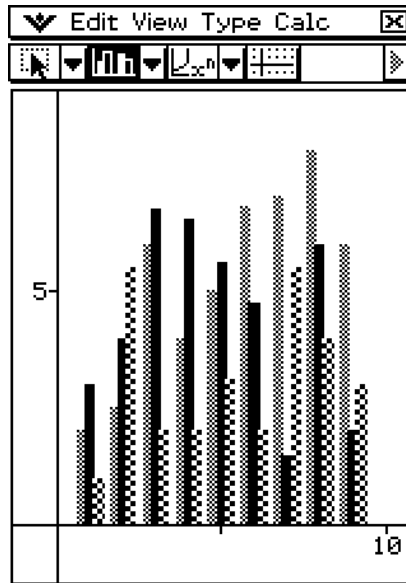

- [Graph] - [Column] - [Stacked] ()

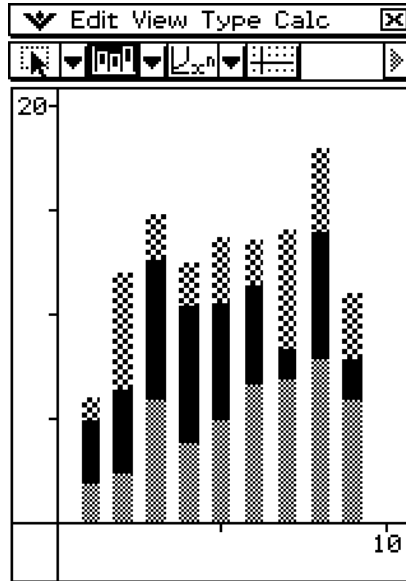

- [Graph] - [Column] - [100% Stacked] ()

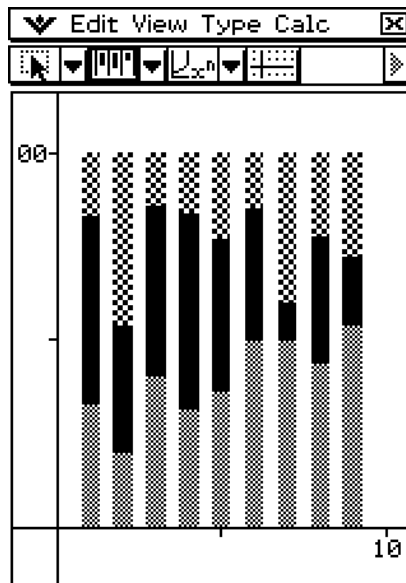

• [Graph] - [Bar] - [Clustered] ()

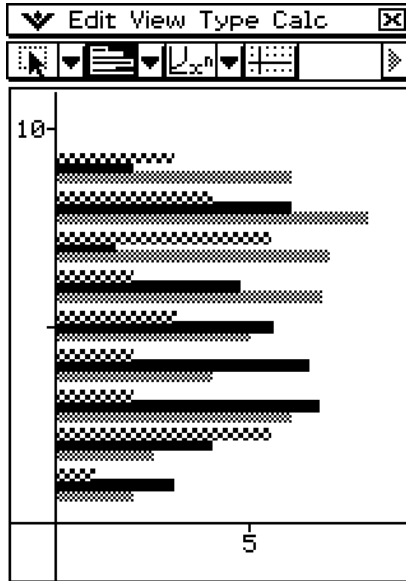

• [Graph] - [Bar] - [Stacked] ()

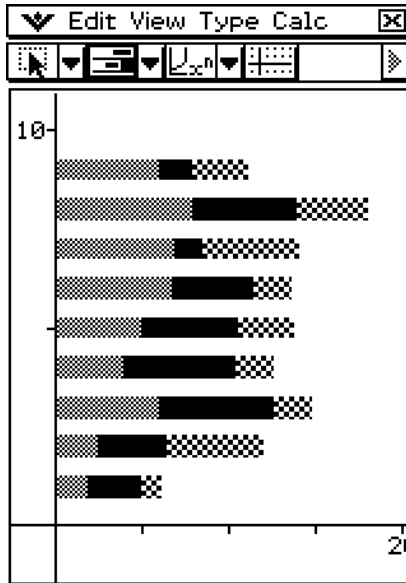

• [Graph] - [Bar] - [100% Stacked] ()

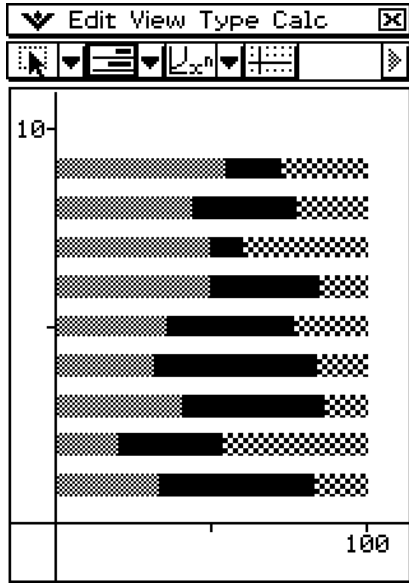

• [Graph] - [Pie] ()

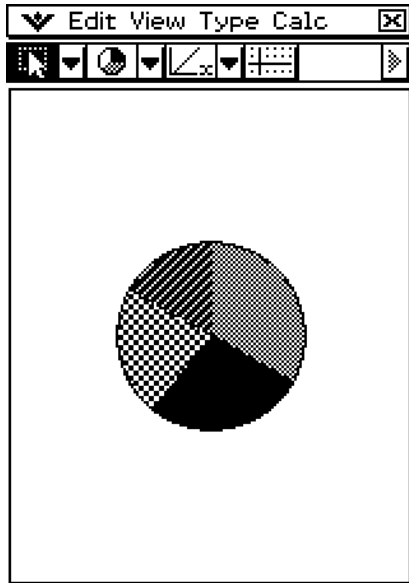

- When you select a pie chart, only the first series (row or column) of the selected data is used.
- Tapping any of the sections of a pie graph causes three values to appear at the bottom of the screen: the cell location, a data value for the section, and a percent value that indicates the portion of the total data that the data value represents.



• [Graph] - [Scatter] ()

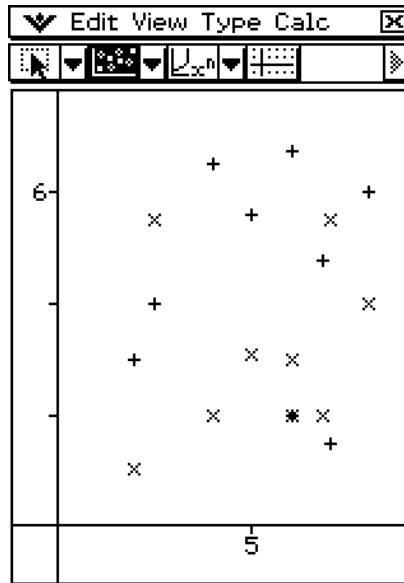

- In the case of a scatter graph, the first series (column or row) of selected values is used as the x -values for all plots. The other selected values are used as the y -value for each of the plots. This means if you select four columns of data (like Columns A, B, C, and D), for example, there will be three different plot point types: (A, B), (A, C), and (A, D).
- Scatter graphs initially have plotted points only. You can add lines by selecting [Lines] on the [View] menu.

• [Graph] - [Histogram] ()

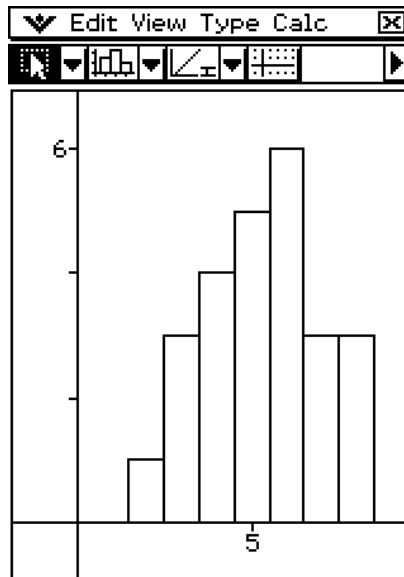

- When you select a histogram graph, only the first column of the selected data is used.



- Tapping any of the bins of a histogram graph causes three values to appear at the bottom of the screen. The first two values (from the left) indicate the range of the selected bin, while the third value indicates the quantity of the selected bin.

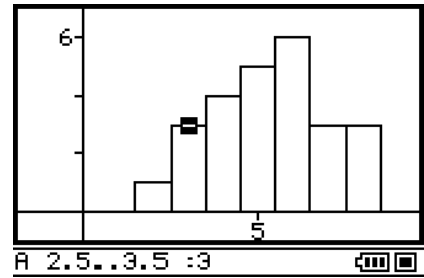

- You can specify the bin width after drawing a histogram graph. On the Graph window that shows the histogram, tap [Bin Width] on the [Calc] menu.
- Dragging any of the bins of a histogram graph to a cell in the spreadsheet window will create a table containing the values of the histogram graph, starting from the cell where you dropped the data.

	A	B	C
30			
31			
32			
33			
34			

	A	B	C
30	1.5	2.5	1
31	2.5	3.5	3
32	3.5	4.5	4
33	4.5	5.5	5
34	5.5	6.5	6
35	6.5	7.5	3

• **[Graph] - [Box Whisker]** ()

This type of graph lets you see how a large number of data items are grouped within specific ranges. A box encloses all the data in an area from the first quartile (Q1) to the third quartile (Q3), with a line drawn at the median (Med). Lines (called whiskers) extend from either end of the box up to the minimum (Min) and maximum (Max) of the data.

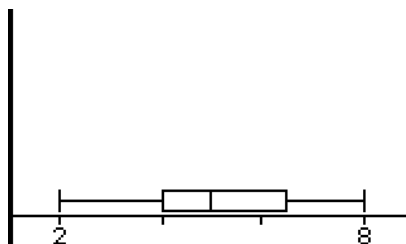

- When you select a box whisker graph, each column will be displayed as a separate box whisker.



13-9-9
Graphing

- Tapping the Q1, Q3, Med, Min, or Max location of a box whisker graph will cause the applicable value to appear at the bottom of the screen.

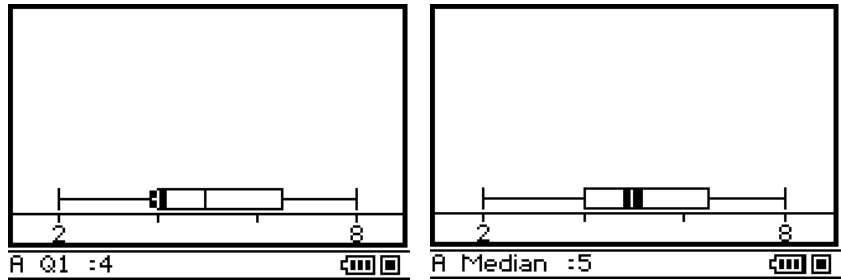

- On the Graph window, checking [Calc] - [Show Outliers] displays outliers instead of whiskers on graph.

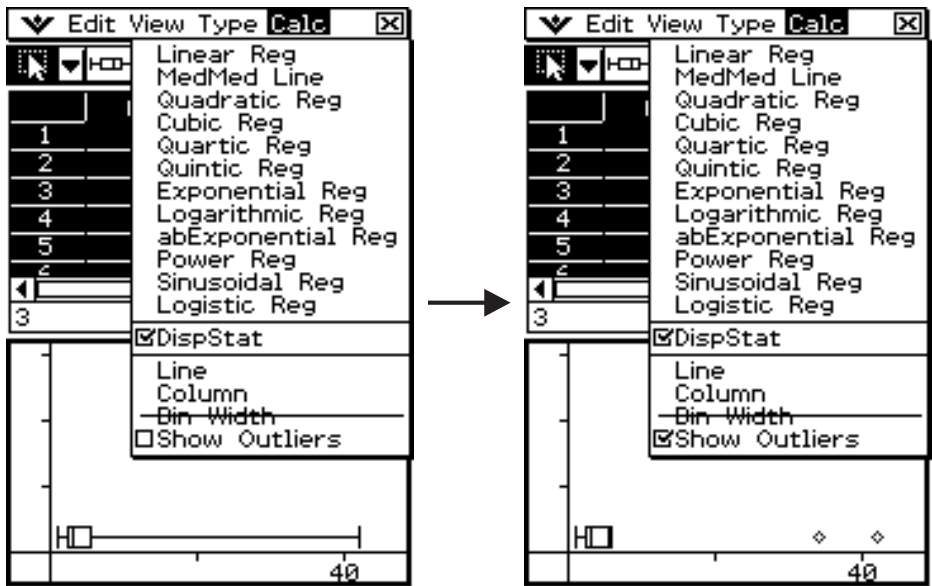

- Dragging a box whisker graph to a cell in the spreadsheet window will create a table containing the graph's values (Min, Q1, Median, Q3, Max), starting from the cell where you drop the graph.

	C	D	E
1	Min	1	
2	Q1	2.5	
3	Median	3	
4	Q3	5.5	
5	Max	42	



• **[Graph] - [Row Series]**

Selecting this option treats each row as a set of data. The value in each column is plotted as a vertical axis value. The following shows a graph of the same data as the above example, except this time [Row Series] is selected.

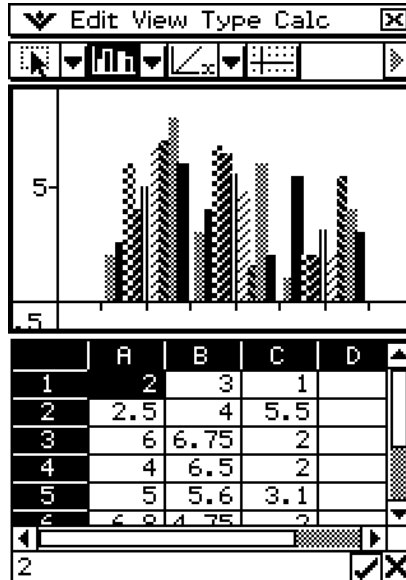

• **[Graph] - [Column Series]**

Selecting this option treats each column as a separate set of data. The value in each row is plotted as a vertical axis value. The following shows a typical clustered column graph while [Column Series] is selected, and the data that produced it.

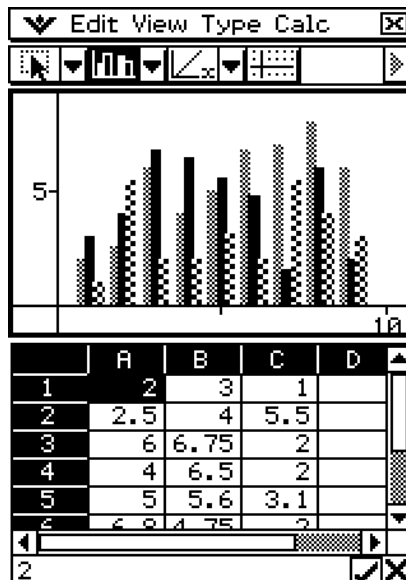

Graph Window Menus and Toolbar

The following describes the special menus and toolbar that appears whenever the Spreadsheet application Graph window is on the display.

■ Menu







- See “Using the  Menu” on page 1-5-4.

■ Edit Menu

- See “Edit Menu” on page 13-2-2.

■ View Menu

Many of the [View] menu commands can also be executed by tapping Spreadsheet application Graph window toolbar buttons.















To do this:	Tap this toolbar button:	Or select this [View] menu item:
Change the function of the stylus so it can be used to select and move points on the displayed graph		Select
Start a box zoom operation		Zoom Box
Activate the pan function for dragging the Graph window with the stylus		Pan
Enlarge the display image		Zoom In
Reduce the size of the display image		Zoom Out
Adjust the size of the display image so it fits the display		Zoom to Fit
Toggle display of axes and coordinate values on and off		Toggle Axes
Toggle line graph and scatter graph plot markers on and off	—	Markers
Toggle line graph and scatter connecting lines on and off	—	Lines



■ Type Menu

- The [Type] menu is identical to the [Graph] menu described on page 13-9-1.

■ Calc Menu

To do this:	Tap this button:	Or select this [Calc] menu item:
Display a linear regression curve		Linear Reg
Display a Med-Med graph		MedMed Line
Display a quadratic regression curve		Quadratic Reg
Display a cubic regression curve		Cubic Reg
Display a quartic regression curve		Quartic Reg
Display a quintic regression curve		Quintic Reg
Display a logarithmic $A\ln(x) + B$ regression curve		Logarithmic Reg
Display an exponential Ae^{Bx} regression curve		Exponential Reg
Display an exponential AB^x regression curve		abExponential Reg
Display a power Ax^B regression curve		Power Reg
Display a sinusoidal regression curve		Sinusoidal Reg
Display a logistic regression curve		Logistic Reg
Convert the data of the selected column to a line graph		Line
Convert the data of the selected line to a column graph		Column
Set bin width for a histogram	—	Bin Width
Show outlying data for box whisker graph	—	Show Outliers

Important!

- Exponential and logarithmic regression curves ignore negative values when calculating the curve. A message appears in the status bar to let you know when negative values are ignored.



Basic Graphing Steps

The following are the basic steps for graphing spreadsheet data.

• **ClassPad Operation**

(1) Input the data you want to graph into the spreadsheet.

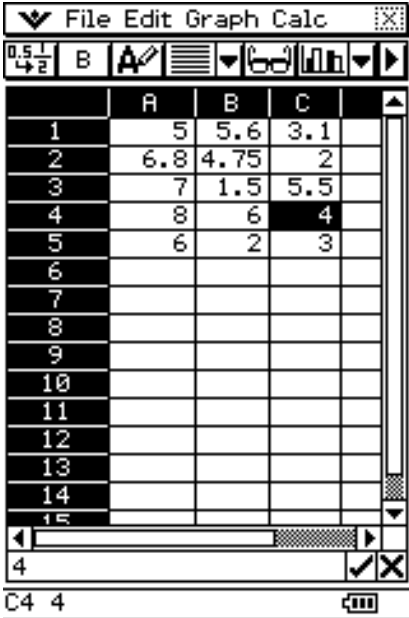

(2) Use the [Graph] menu to specify whether you want to graph the data by row or by column.

To do this:	Select this [Graph] menu option:
Graph the data by row	Row Series
Graph the data by column	Column Series

- See “Graph Menu” on page 13-9-1 for more information.

(3) Select the cells that contain the data you want to graph.

- See “Selecting Cells” on page 13-3-5 for information about selecting data.



(4) On the [Graph] menu, select the type of graph you want to draw. Or you can tap the applicable icon on the toolbar.

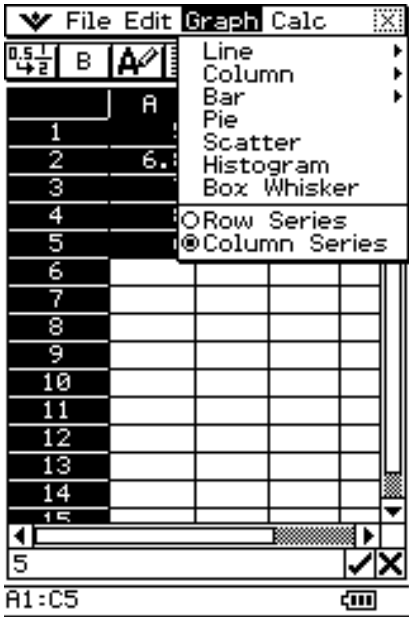

- This draws the selected graph. See “Graph Menu” on page 13-9-1 for examples of the different types of graphs that are available.
- You can change to another type of graph at any time by selecting the graph type you want on the [Type] menu. Or you can tap the applicable icon on the toolbar.



Regression Graph Operations

After plotting a scatter graph of paired-variable spreadsheet data (Single-variable and Paired-variable Statistical Calculations, page 13-6-1), you can draw a regression graph that approximates the scatter graph and determine the regression formula.

• To plot a scatter graph and then draw its regression graph

- (1) Enter the paired-variable data into the spreadsheet, and then select the range of cells where it is located.
 - This plots the scatter graph for the data you selected in step 1.
- (2) Tap [Graph] and then [Scatter].
 - This superimposes the regression graph on the scatter graph. Also, the regression calculation result window will appear in the half of the display.

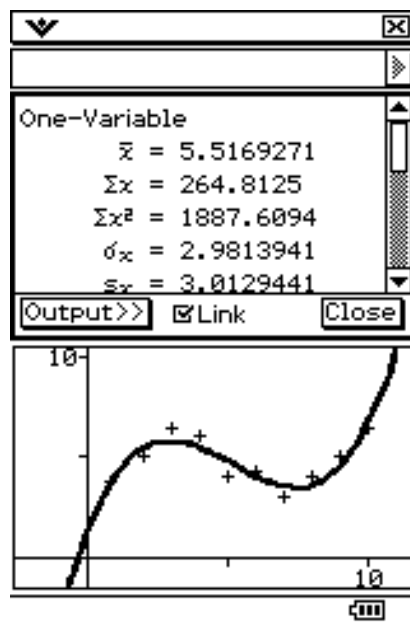

Tip

- For details about how to use the Link check box and [Output>>] button on the regression calculation result window, see "Regression Calculations" (page 13-6-2).
- Note that the regression calculation result window is not available for Quintic Reg.

Other Graph Window Operations

This section provides more details about the types of operations you can perform while the Graph window is on the display.

- **To show or hide lines and markers**

(1) While a line graph or a scatter graph is on the Graph window, tap the [View] menu.

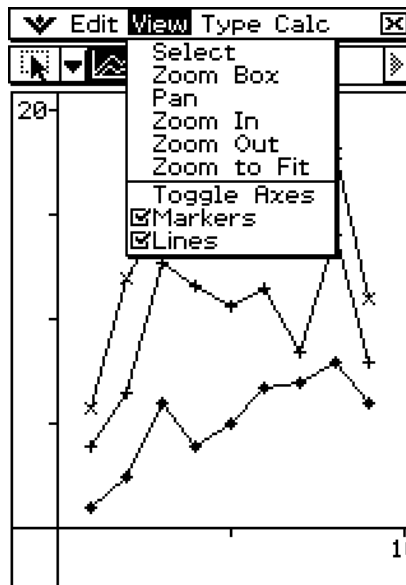

Lines and markers both turned on

(2) Tap the [Markers] or [Lines] item to toggle it between show (checkbox selected) and hide (checkbox cleared).

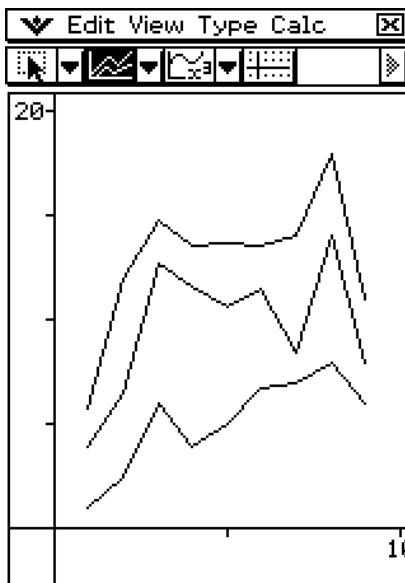

Lines turned on, markers hidden

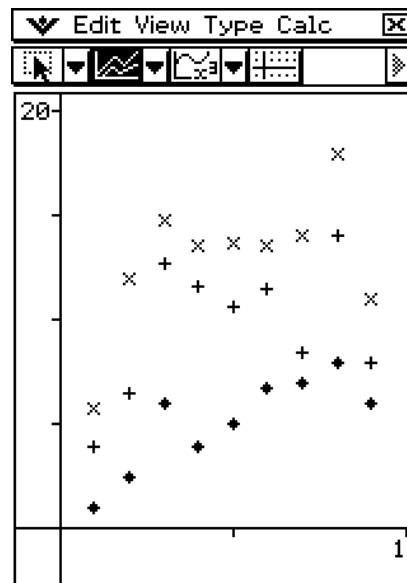

Markers turned on, lines hidden

- Line and scatter graphs can have markers only, lines only, or both markers and lines. You cannot turn off both markers and lines at the same time.



• To change a line in a clustered line graph to a column graph

(1) Draw the clustered line graph.

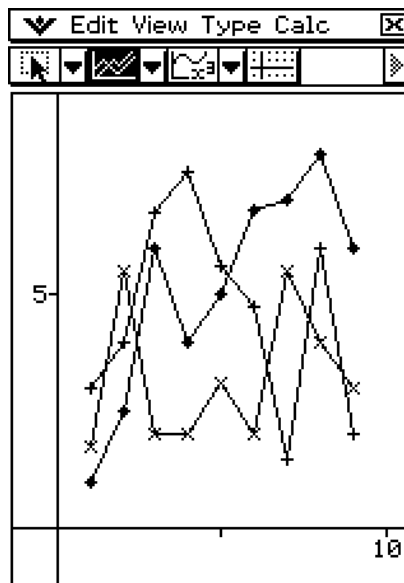

(2) With the stylus, tap any data point on the line you wish to change to a column graph.

(3) On the [Calc] menu, tap [Column].

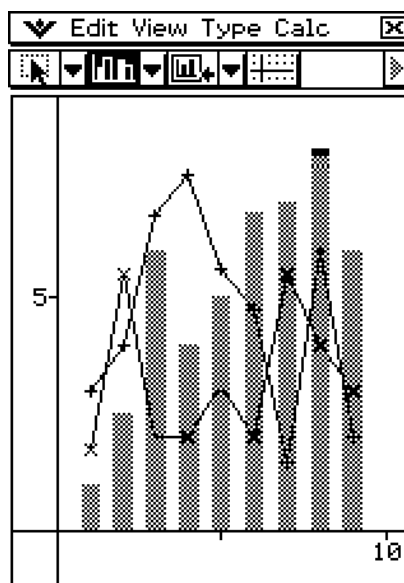

- You could also tap the down arrow button next to the third tool button from the left, and then tap .
- You can change more than one line to a column graph, if you want.
- You can change a column graph back to a line graph by selecting one of its columns and tapping [Line] on the [Calc] menu.



• **To change a column in a clustered column graph to a line**

(1) Draw the clustered column graph.

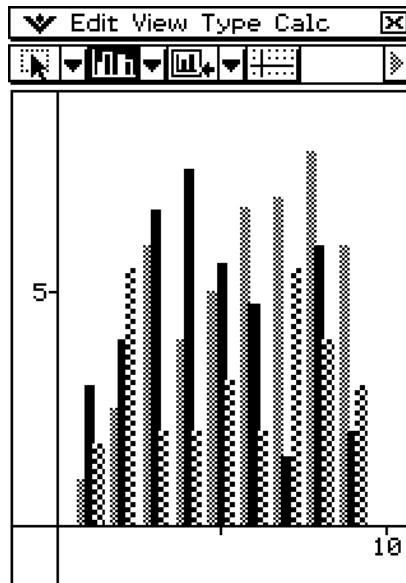

(2) With the stylus, tap any one of the columns you wish to change to a line graph.

(3) On the [Calc] menu, tap [Line].

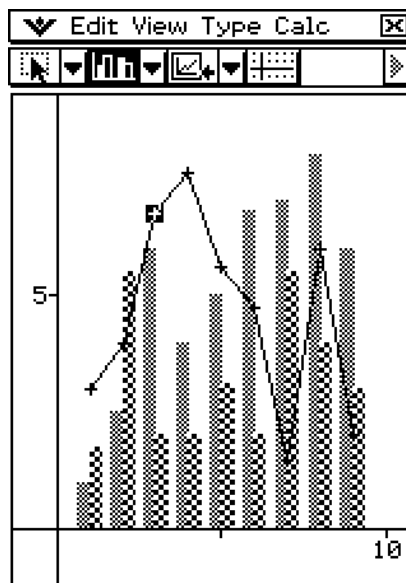

- You could also tap the down arrow button next to the third tool button from the left, and then tap .
- You can change more than one column to a line graph, if you want.
- You can change a line graph back to a column graph by selecting one of its data points and tapping [Column] on the [Calc] menu.



• **To find out the percentage of data for each pie graph section**

- (1) While the display is split between the pie graph and the Spreadsheet windows, tap the pie graph to select it.
- (2) On the [Edit] menu, tap [Copy].
- (3) Tap the Spreadsheet window to make it active.
- (4) Tap the cell where you want to paste the data.
 - The cell you tap will be the upper left cell of the group of cells that will be pasted.
- (5) On the [Edit] menu, tap [Paste].
 - This pastes two columns of values. The numbers in the left column are pie graph section numbers. The values in the right column are the percentages that the data in each section of the pie graph represents.

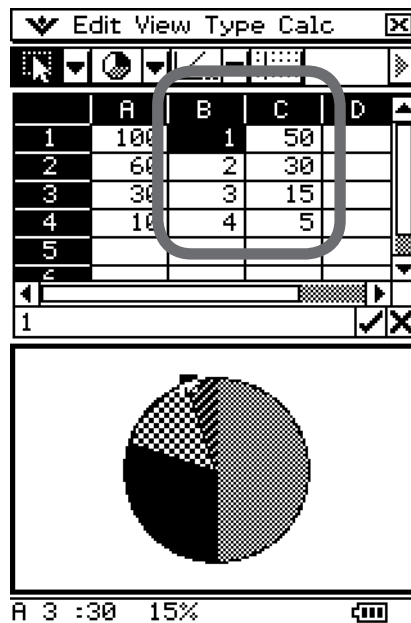

• **To change View Window settings**

- (1) While a graph is on the Graph window, tap , and then [View Window].
 - This displays the current View Window settings.
- (2) Change the View Window settings, if you want.
 - See “Configuring View Window Parameters for the Graph Window” on page 3-2-1 for information about using the View Window.
- (3) After the settings are the way you want, tap [OK] to apply them.



• **To change the appearance of the axes**

While a graph is on the Graph window, select [Toggle Axes] on the [View] menu or tap the  toolbar button to cycle through axes settings in the following sequence: axes on → axes and values on → axes and values off →.

• **To change the appearance of a graph by dragging a point**

While a graph is on the Graph window, use the stylus to drag any one of its data points to change the configuration of the graph.

- You can change curves, make bars or columns longer or shorter, or change the size of pie graph sections.
- Changing a graph automatically changes the graph's data on the Spreadsheet window.

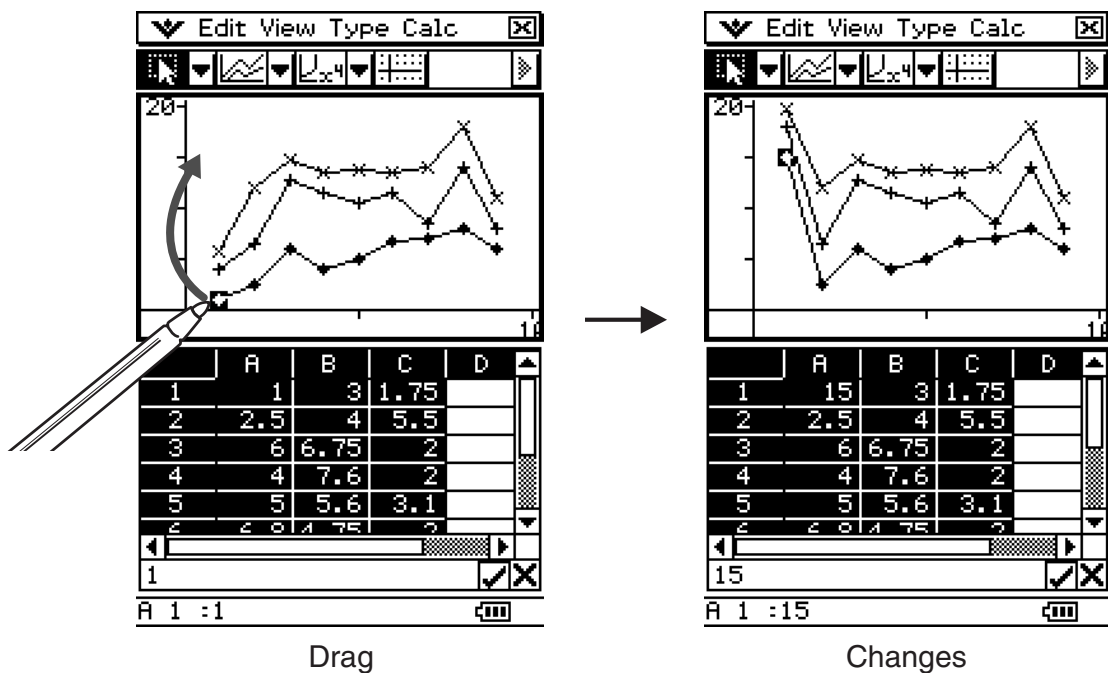

- If a regression curve is displayed for the data whose graph is being changed by dragging, the regression curve also changes automatically in accordance with the drag changes.
- When you edit data in the spreadsheet and press **(EXE)**, your graph will update automatically.

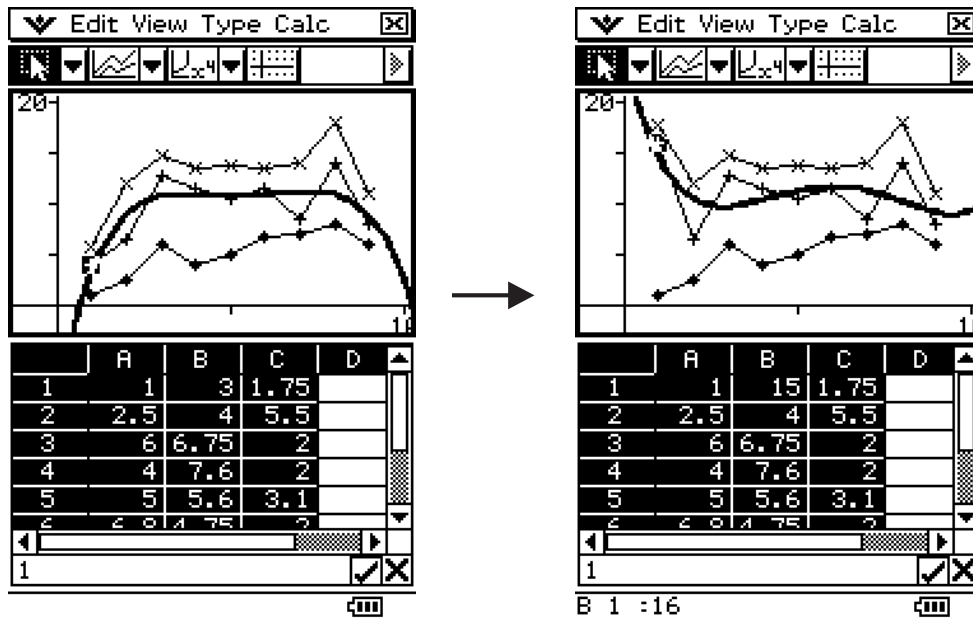

Important!

- You can drag a point only if it corresponds to a fixed value on the spreadsheet. You cannot drag a point if it corresponds to a formula.
- You may encounter the message “Insufficient System Memory to Run...” if you are using a large amount of data and formulas.



Chapter 14

Using the Differential Equation Graph Application

This chapter explains how to use the Differential Equation Graph application, which you can use to investigate families of solutions to ordinary differential equations (ODE).

- 14-1 Differential Equation Graph Application Overview
- 14-2 Graphing a First Order Differential Equation
- 14-3 Graphing a Second Order Differential Equation
- 14-4 Graphing an Nth-order Differential Equation
- 14-5 Drawing $f(x)$ Type Function Graphs and Parametric Function Graphs
- 14-6 Configuring Differential Equation Graph View Window Parameters
- 14-7 Differential Equation Graph Window Operations

14-1 Differential Equation Graph Application Overview

This section explains how to use the Differential Equation Graph application screen, and describes the basic configuration of the Differential Equation Graph application windows.

Differential Equation Graph Application Features

You can use the Differential Equation Graph application to draw the following types of graphs.

1st-order differential equation graphs

- Slope field of a first order differential equation ($y' = dy/dx = f(x, y)$)
- Solution curves when initial conditions are imposed on a first order differential equation

2nd-order differential equation graphs

- Phase plane of two first order differential equations ($x' = dx/dt = f(x, y)$; $y' = dy/dt = f(x, y)$)
- Solution curves when initial conditions are imposed on a set of two first order differential equations

Nth-order differential equation graphs

- Solution curves when initial conditions are imposed on a set of multiple first order differential equations ($y_1' = dy_1/dx = f(x, y)$; $y_2' = dy_2/dx = f(x, y)$; ... ; $y_n' = dy_n/dx = f(x, y)$)

General graphs

- $f(x)$ type function graphs
- Parametric function graphs



Starting Up the Differential Equation Graph Application

Use the following procedure to start up the Differential Equation Graph application.

• ClassPad Operation

On the application menu, tap .

This starts the Differential Equation Graph application and displays the Differential Equation Editor window and the Differential Equation Graph window.

Differential Equation Graph Application Window

The Differential Equation Graph application has two windows, which are described below.

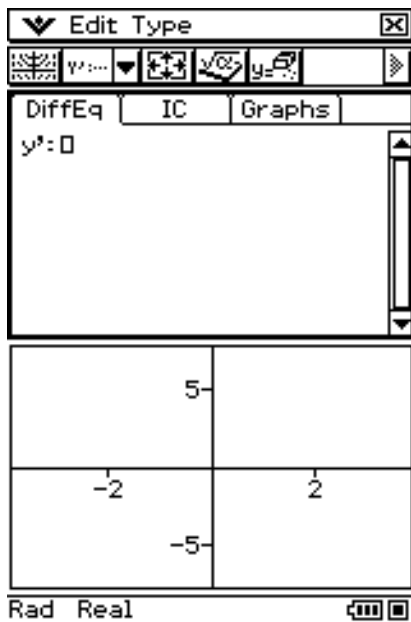

Differential Equation Editor window

Use this window to input expressions and initial conditions for graphing.

Differential Equation Graph window

This window shows the graph of the expression that you input into the Editor window.



■ Differential Equation Editor Window Screens

The Differential Equation Editor window has three different editor screens. The editor screen you should use depends on what you want to input, as described below.

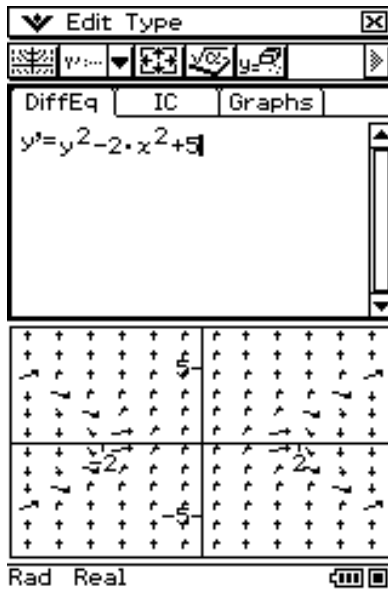

Differential equation editor
([DiffEq] tab)

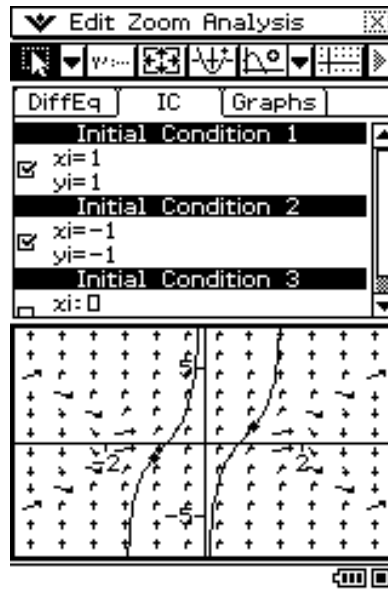

Initial condition editor
([IC] tab)

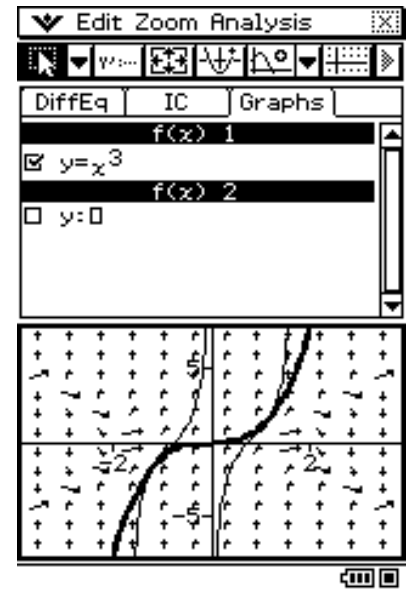



General graph editor
([Graphs] tab)

To input this:	Tap this tab:	To display this editor screen:
Differential equation or a set of differential equations	[DiffEq]	Differential equation editor
Initial conditions to graph solution curves of a differential equation (or a set of differential equations) input on the [DiffEq] tab	[IC]	Initial condition editor
$f(x)$ type functions or parametric functions	[Graphs]	General graph editor



Differential Equation Editor Window Menus and Buttons

This section provides basic information about Differential Equation Editor window menus and commands.

- For information about the  menu, see “Using the  Menu” on page 1-5-4.

Edit Menu ([DiffEq], [IC], [Graphs])

To do this:	Select this Edit menu item:
Cut the selected character string and place it onto the clipboard	Cut
Copy the selected character string and place it onto the clipboard	Copy
Paste the contents of the clipboard at the current cursor position on the Differential Equation Editor window	Paste
Select the entire expression you are editing	Select All
Delete the line of data at the current cursor location	Delete Line
Clear all input data from the currently displayed tab ([DiffEq], [IC], or [Graphs])	Clear All

Type Menu ([DiffEq])





To input this:	Select this Type menu item:
A single first order differential equation	1st (Slope Field)
A single second order differential equation or a set of two first order differential equations	2nd (Phase Plane)
A higher order differential equation or a set of multiple differential equations	Nth (No Field)

Type Menu ([Graphs])



To input this:	Select this Type menu item:
$f(x)$ type functions	$f(x)$
Parametric functions	Parametric





Toolbar Buttons ([DiffEq], [IC], [Graphs])

To do this:	Tap this button:
Graph the selected function(s)	
Display the View Window dialog box to configure Differential Equation Graph window settings	
Display the Main application window	
Delete the line of data at the current cursor location	



Toolbar Buttons ([DiffEq])

To input this:	Tap this button:
A single first order differential equation	
A single second order differential equation or a set of two first order differential equations	
A higher order differential equation or a set of multiple differential equations	

Toolbar Buttons ([IC], [Graphs])

To select this graph line thickness:	Tap this button:
Normal	
Thick	

Toolbar Buttons ([Graphs])

To input this:	Tap this button:
$f(x)$ coordinate type functions	
Parametric functions	



Differential Equation Graph Window Menus and Buttons

This section provides basic information about Differential Equation Graph window menus and commands.

Edit Menu

To do this:	Select this Edit menu item:
Toggle arrows to indicate the direction of slope field or phase plane vectors on and off	Arrows
Toggle the use of unit vectors for slope field or phase plane graphing on and off	Unit Vectors
Display the Differential Equation Editor window [DiffEq] tab	Editor - DiffEq.Editor
Display the Differential Equation Editor window [IC] tab	Editor - IC Editor
Display the Differential Equation Editor window [Graphs] tab	Editor - Graph Editor
Clear all currently registered initial conditions (and, as a result, all solution curves)	Clear All

Zoom Menu













To do this:	Select this Zoom menu item:
Enlarge the part of the screen bounded by a box	Box
Zoom in by the zoom factor	Zoom In
Zoom out by the zoom factor	Zoom Out
Return a graph to its original size	Original
Adjust View Window x -axis values so they are identical to the y -axis values	Square
Return View Window parameters to their settings prior to the last zoom operation	Previous
Return the Differential Equation Graph window to its initial default state	Quick Initialize



Analysis Menu

To do this:	Select this Analysis menu item:
Pan the graph window	Pan
Select and move initial condition point	Select
Trace the graph of a solution curve	Trace
Register the coordinates at the location you tap on the Differential Equation Graph window as the initial condition, and graph the solution curve based on that initial condition	Modify

Toolbar Buttons

To do this:	Tap this button:
Select and move the initial condition point	
Pan the graph window	
Zoom in by the zoom factor	
Zoom out by the zoom factor	
Enlarge the part of the screen bounded by a box	
Make the Differential Equation Editor window active	
Display the View Window dialog box to configure Differential Equation Graph window settings	
Register the coordinates at the location you tap on the Differential Equation Graph window as the initial condition, and graph the solution curve based on that initial condition	
Display a trace cursor that can be positioned on any x, y coordinate	
Display a trace cursor that can be positioned on any grid point that has a field line	
Display a trace cursor that can be positioned on any solution curve	
Turn display of axes and coordinate values on and off	



Differential Equation Graph Application Status Bar

The status bar at the bottom of the Differential Equation Graph application shows the current angle unit setting and [Complex Format] setting (page 1-9-5).

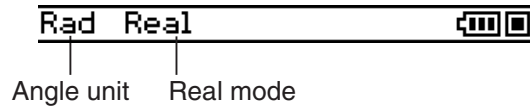

If you see this:	It means this:
Rad	The angle unit setting is radians.
Deg	The angle unit setting is degrees.
Gra	The angle unit setting is grads.
Cplx	The Complex (complex number calculation) mode is selected.
Real	The Real (real number calculation) mode is selected.



14-2 Graphing a First Order Differential Equation

This section explains how to input a first order differential equation and draw a slope field, and how to graph the solution curve(s) of a first order differential equation based on given initial conditions.

Inputting a First Order Differential Equation and Drawing a Slope Field

A slope field is the family of solutions of a single, first order differential equation of the form $y' = f(x, y)$. It is a grid of solution lines where each line has the slope y' for a given grid value of x and y . It is often referred to as a “slope field” or “direction field” because only the direction of the field at any given point is known, not the magnitude.

Example: To input $y' = y^2 - x$ and draw its slope field

• ClassPad Operation

(1) On the application menu, tap .

- This starts up the Differential Equation Graph application and activates the differential equation editor ([DiffEq] tab).

(2) Tap [Type] - [1st (Slope Field)] or the  toolbar button.

(3) Press the  key to display the soft keyboard.

(4) Input $y' = y^2 - x$.



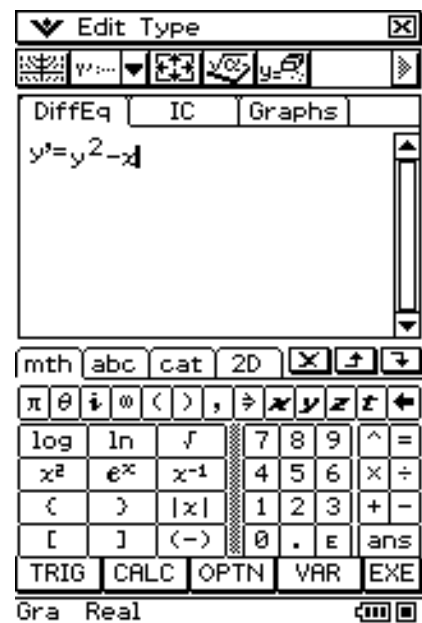

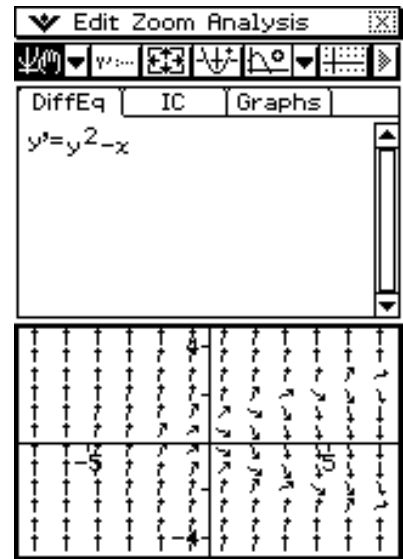

(5) Tap .

- This draws the slope field of $y' = y^2 - x$.



(6) Tap , or tap  and then tap [View Window] to display the View Window dialog box, and configure the View Window settings as shown below.

- For details about View Window settings, see “Configuring Differential Equation Graph View Window Parameters” on page 14-6-1.

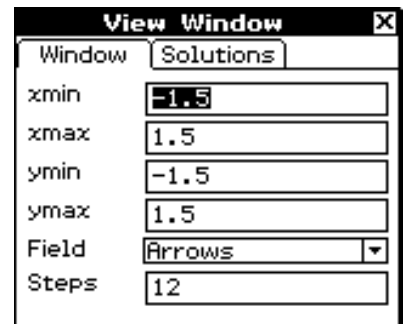

(7) After the settings are the way you want, tap [OK].

- This updates the slope field in accordance with the new View Window settings.

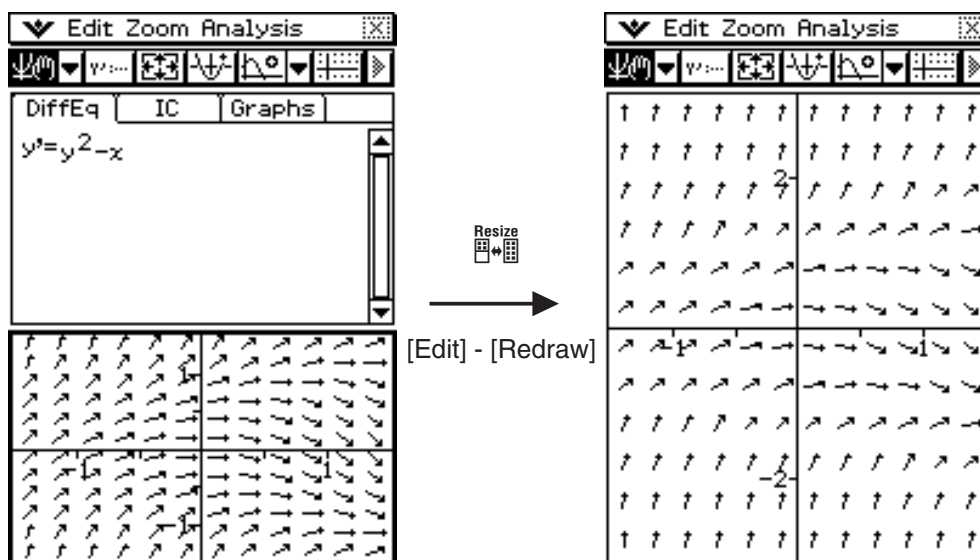

Inputting Initial Conditions and Graphing the Solution Curves of a First Order Differential Equation

You can use the procedure in this section to overlay, onto the slope field, solution curves of the first order differential equation input on the [DiffEq] tab for given initial conditions.

Example: To input the first order differential equation $y' = y^2 - x$, draw its slope field, and then graph three solution curves for the initial conditions $(x_i, y_i) = (0,0), (0,0.5), (0,1)$

• ClassPad Operation

- (1) Use the procedure under “Inputting a First Order Differential Equation and Drawing a Slope Field” on page 14-2-1 to draw the slope field for $y' = y^2 - x$.
- (2) Activate the Differential Equation Editor window and then tap the [IC] tab.
 - This displays the initial condition editor.
- (3) On the initial condition editor, input the following initial conditions: $(x_i, y_i) = (0,0), (0,0.5), (0,1)$. Perform the following operations.

0 **EXE** **0** **EXE** **0** **EXE** **0** **•** **5** **EXE** **0** **EXE** **1** **EXE**

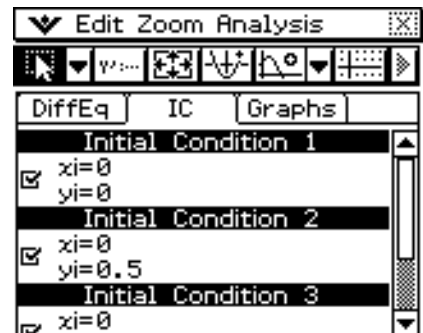

- (4) Tap .

- This graphs the three solution curves over the slope field of $y' = y^2 - x$.

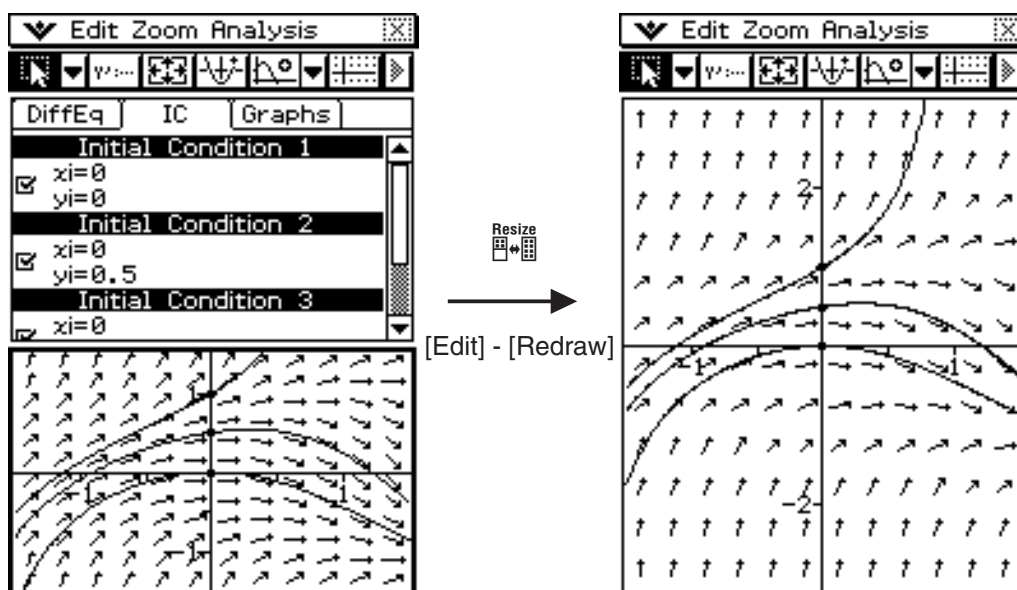

Configuring Solution Curve Graph Settings

You can specify whether or not a solution curve should be drawn for each initial condition input on the initial condition editor. You can also specify either a normal or thick line for solution curves.

- **To configure the solution curve draw setting**

Use the initial condition editor to select the check box to the left of each initial condition input box (Initial Condition 1, Initial Condition 2, etc.) whose solution curve you want to graph. The solution curve of any initial condition whose check box is not selected will not be graphed.

Example: To perform the operation under “Inputting Initial Conditions and Graphing the Solution Curves of a First Order Differential Equation” on page 14-2-3, clear the Initial Condition 2 checkbox, and then draw the graph

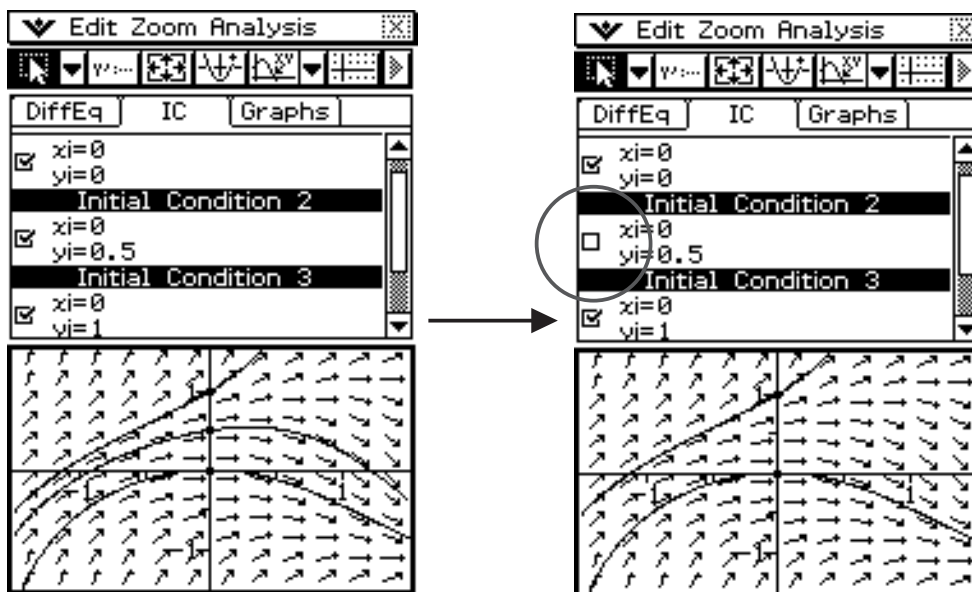

- **To specify the line thickness for drawing a solution curve**

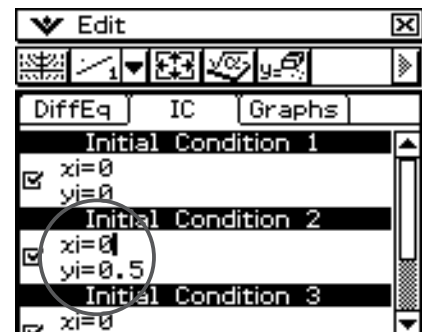

(1) Tap the input box of the initial condition whose line thickness you want to change.

- This displays the cursor in the initial condition input box you tapped.

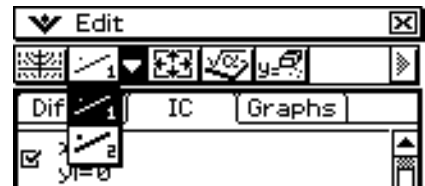

(2) Tap the down arrow button on the toolbar.



(3) Tap  on the toolbar to draw the solution curve with a thin line, or  to draw with a thick line.

(4) To apply your setting to the graph, tap .

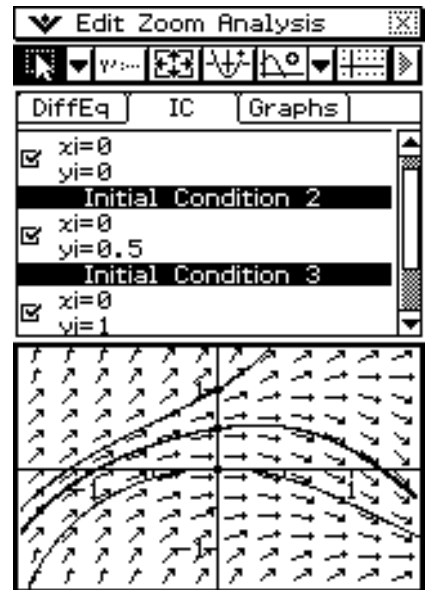

14-3 Graphing a Second Order Differential Equation

This section explains how to input a second order differential equation and draw a slope field, and how to graph the solution curve(s) for a second order differential equation based on given initial conditions.

With this application, a second order differential equation is input in the form of a set of two first order differential equations.

Drawing the Phase Plane of a Second Order Differential Equation

A phase plane is the family of solutions of either a second order differential equation or two first order differential equations of the form $x' = dx/dt = f(x,y)$ and $y' = dy/dt = g(x,y)$. A single second order differential equation can also be graphed, but it must be written as two first order differential equations.

Example: To input $\{x' = x, y' = -y\}$ and draw its phase plane

• ClassPad Operation

(1) On the application menu, tap  DiffEqGraph.

- This starts up the Differential Equation Graph application and activates the differential equation editor ([DiffEq] tab).

(2) Tap [Type] - [2nd (Phase Plane)] or the  toolbar button.

(3) Use the differential equation editor to input $x' = x, y' = -y$.



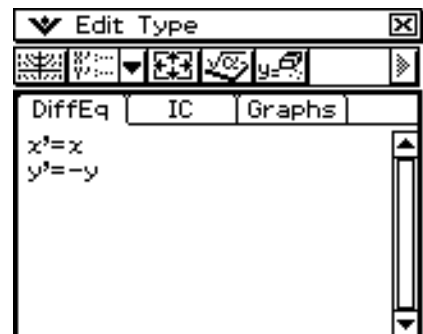

(4) Tap .

- This draws the phase plane of $x' = x$, $y' = -y$.

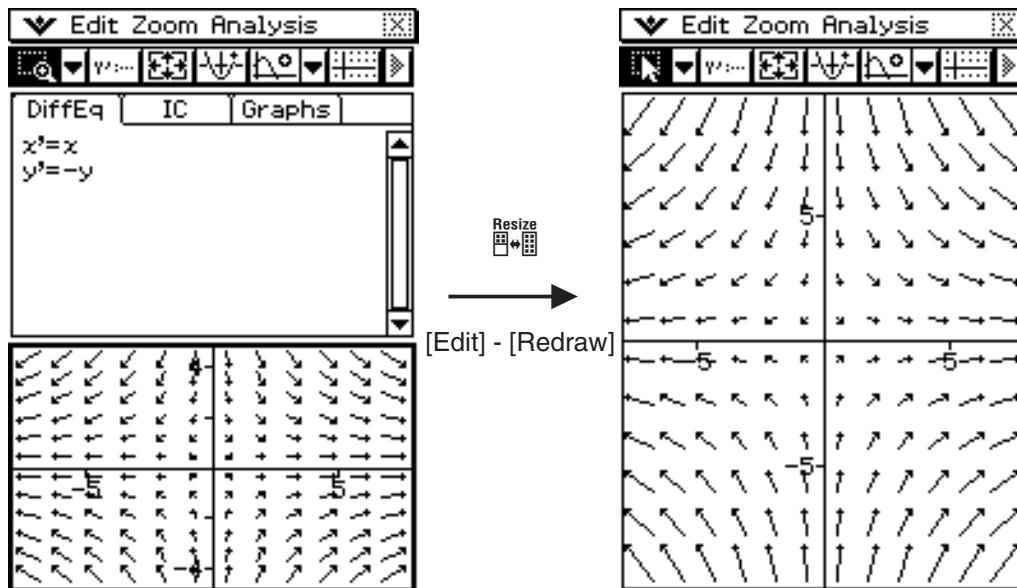

Inputting Initial Conditions and Graphing the Solution Curve of a Second Order Differential Equation

You can use the procedure in this section to overlay, onto the slope field, solution curve of the second order differential equation input on the [DiffEq] tab for given initial conditions.

Example: To input the second order differential equation $\{x' = x, y' = -y\}$, draw the phase plane, and then graph the solution curve of the initial condition $(x_i, y_i) = (1, 1)$

The independent variable minimum value (t_{min}) = -7.7, maximum value (t_{max}) = 7.7, and initial value (t_0) = 0.

• ClassPad Operation

- (1) Use the procedure under “Drawing the Phase Plane of a Second Order Differential Equation” on page 14-3-1 to draw the phase plane for $\{x' = x, y' = -y\}$.
- (2) Activate the Differential Equation Editor window and then tap the [IC] tab.
 - This displays the initial condition editor.
- (3) Input $(x_i, y_i) = (1, 1)$ into the initial condition editor.

Select the check box next to “ x_i =” and then tap

   .

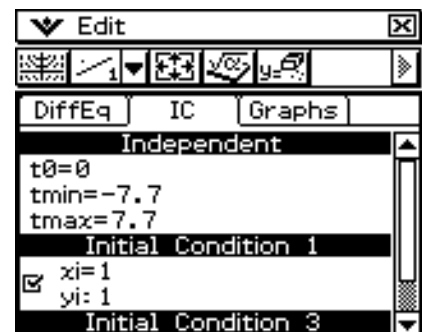

(4) Tap .

- This graphs the solution curve and overlays it on the phase plane of $\{x' = x, y' = -y\}$.

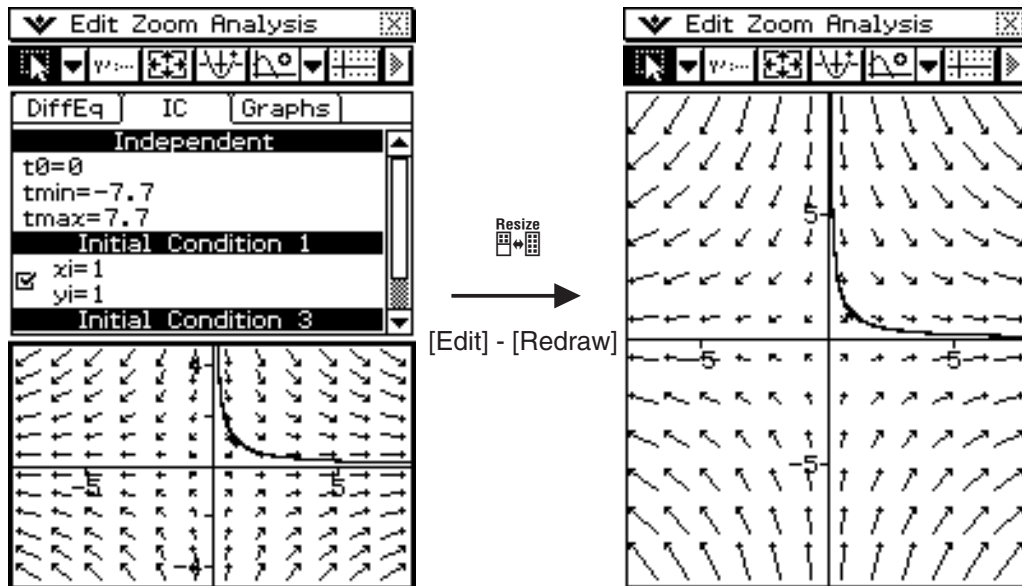

Tip

- You can also draw a solution curve using [Modify] in the Analysis menu (page 14-1-7).



14-4 Graphing an Nth-order Differential Equation

This section explains how to graph the solution curve(s) for an nth order (higher order) differential equation based on specified initial conditions.

With this application, an nth order differential equation is input in the form of a set of multiple first order differential equations.

Inputting an Nth-order Differential Equation and Initial Conditions, and then Graphing the Solutions

You can use the procedure in this section to graph the solution curves of the Nth-order differential equation input on the [DiffEq] tab for given initial conditions.

Note

- For Nth-order differential equations, only solution curves are drawn.

Example: To specify the three initial conditions $(x_i, y_{1i}, y_{2i}) = (0, -1, 0), (0, 0, 0), (0, 1, 0)$ for the differential equation $y'' = x - y$ and graph its solution curves

• ClassPad Operation

(1) On the application menu, tap .

- This starts up the Differential Equation Graph application and activates the differential equation editor ([DiffEq] tab).

(2) Tap [Type] - [Nth (No Field)] or the  toolbar button.

(3) Use the differential equation editor to input $y'' = x - y$.

- Input $y'' = x - y$ by dividing it into two first order differential equations. If we let $y_1 = y$ and $y_2 = y'$, we see that $y_1' = y' = y_2$ and $y_2' = y'' = x - y_1$.



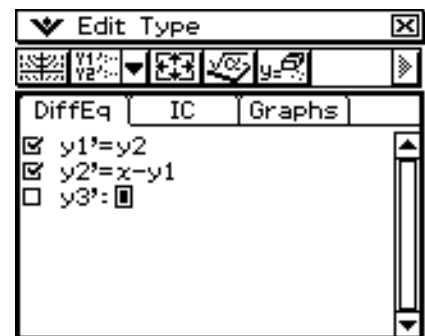



(4) Tap the [IC] tab to display the initial condition editor.

(5) Use the initial condition editor to input $(x_i, y_{1i}, y_{2i}) = (0, -1, 0), (0, 0, 0), (0, 1, 0)$.

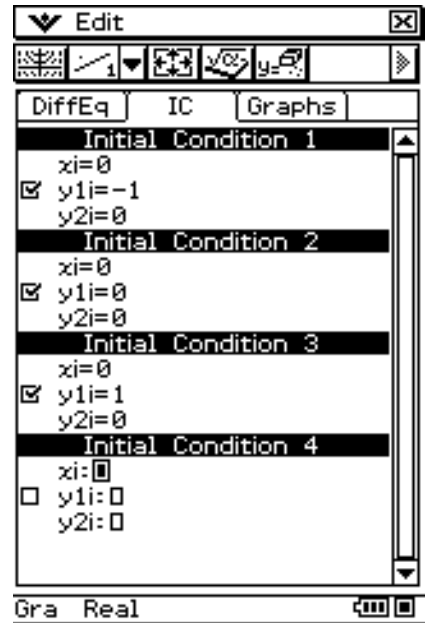
0 [EXE] (←) 1 [EXE] 0 [EXE]
 0 [EXE] 0 [EXE] 0 [EXE]
 0 [EXE] 1 [EXE] 0 [EXE]



(Tapping  on this screen will cause the initial condition editor to fill the entire window.)

(6) Tap .

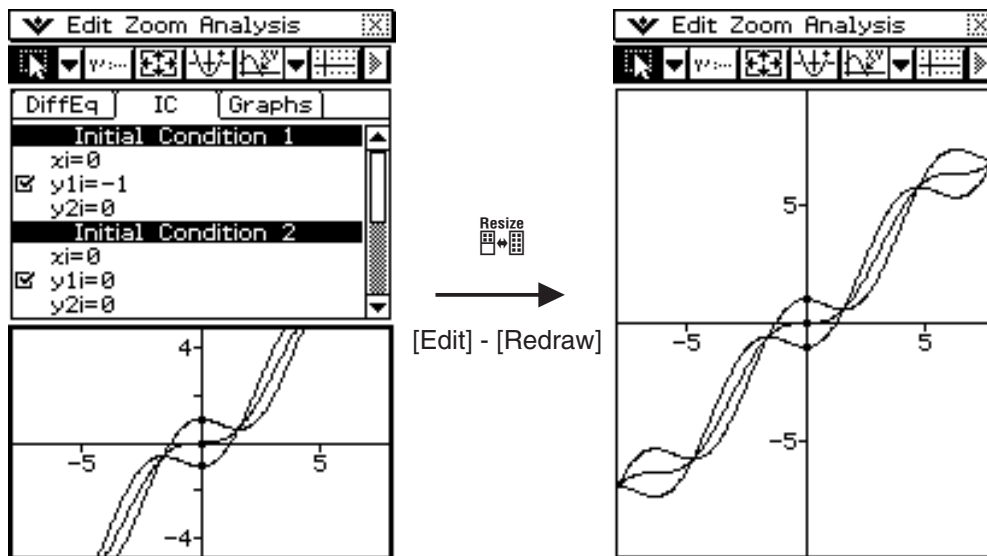

14-5 Drawing $f(x)$ Type Function Graphs and Parametric Function Graphs

You can use the Differential Equation Graph application to graph $f(x)$ type function graphs and parametric function graphs, the same way as you do with the Graph & Table application. These types of graphs can be overlaid on differential equation graphs.

Drawing an $f(x)$ Type Function Graph

Example: To overlay a differential equation graph with the graphs of $y = x^2$ and $y = -x^2$

• ClassPad Operation

- (1) Graph a differential equation.
 - See sections 14-2, 14-3, and 14-4.
- (2) Tap the [Graphs] tab to display the general graph editor.
- (3) Tap [Type] – [$f(x)$] or the $y=$ toolbar button.
- (4) Input $y = x^2$ and $y = -x^2$.

[mth] [x] [^] [2] [EXE]
 [(-) [x] [^] [2] [EXE]

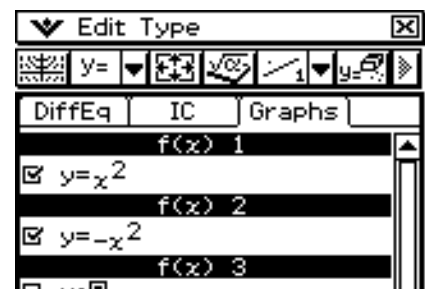

- (5) Tap [Grid] .

• This will overlay the graphs of $y = x^2$ and $y = -x^2$ on the differential equation graph.

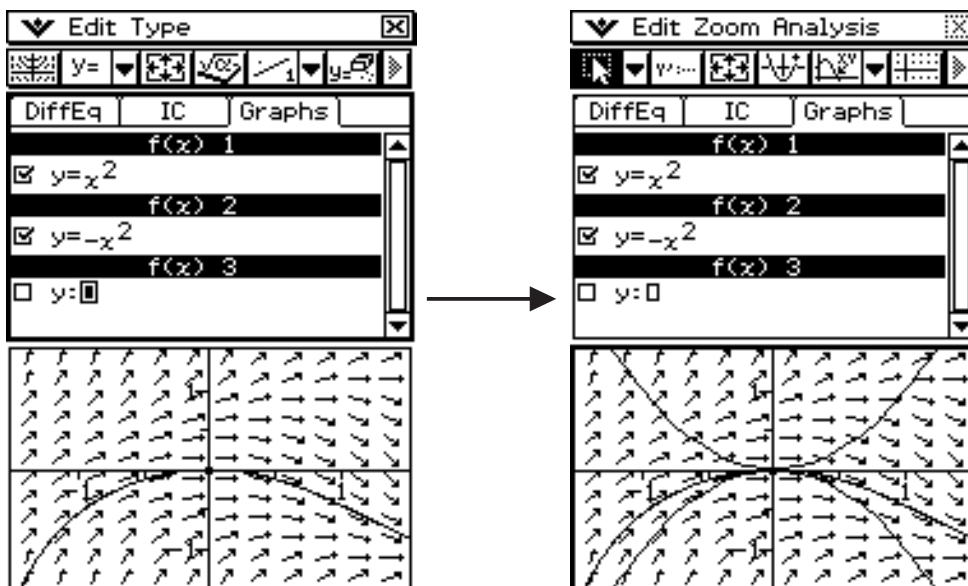

Drawing a Parametric Function Graph

Example: To graph $\{xt = 3\sin(t) + 1, yt = 3\cos(t) + 1\}$ and $\{xt = \sin(t) - 1, yt = \cos(t) - 1\}$
(Angle Unit Setting: radian, $0 \leq t \leq 2\pi$)

• ClassPad Operation

- (1) Tap the [Graphs] tab to display the general graph editor.
- (2) Confirm that “Rad” is displayed as the angle unit setting on the left side of the status bar. If it isn’t, tap the angle setting until “Rad” is displayed.
 - For details about the information that appears in the status bar, see “Differential Equation Graph Application Status Bar” on page 14-1-8.
- (3) Tap [Type] - [Parametric] or the $x:=$ toolbar button.
- (4) Input the expression for each graph, and ($0 \leq t \leq 2\pi$) for the range of t .

mth 3 TRIG sin $($ t $)$ $+$ 1 EXE
 3 cos $($ t $)$ $+$ 1 EXE
 0 EXE 2 π EXE
 mth sin $($ t $)$ $-$ 1 EXE
 cos $($ t $)$ $-$ 1 EXE
 0 EXE 2 π EXE

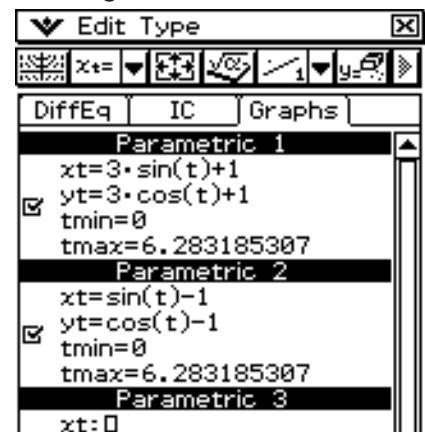

- (5) Tap  to draw the graph.
 - To adjust the graph window, tap [Zoom] and then [Quick Initialize].

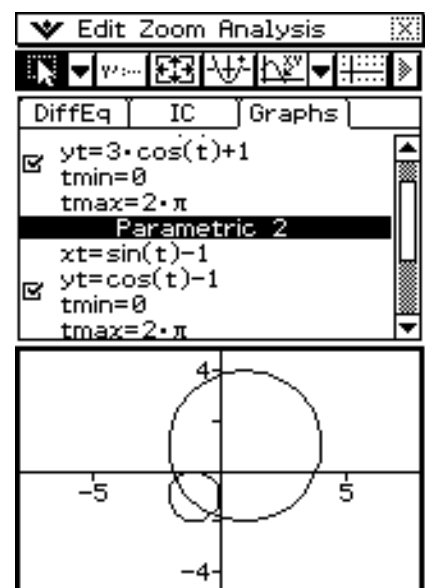

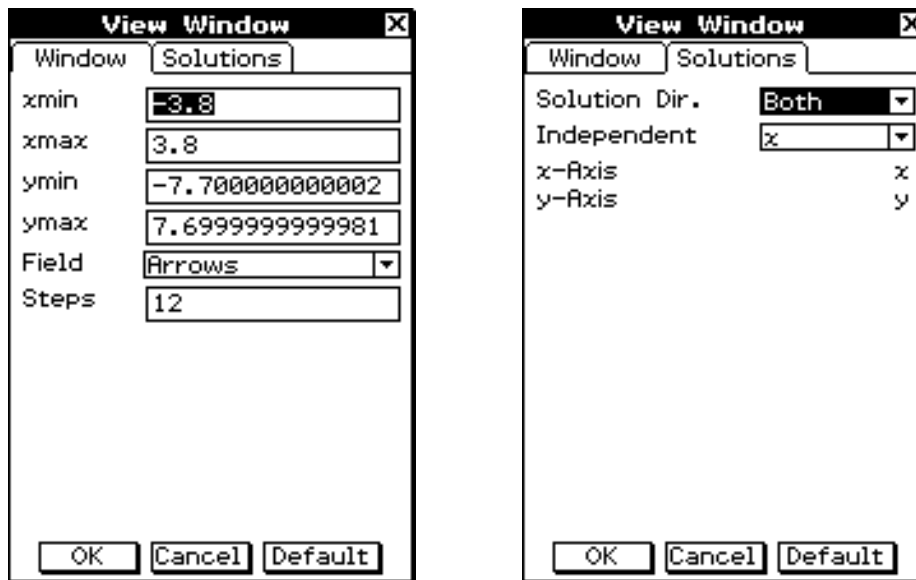

14-6 Configuring Differential Equation Graph View Window Parameters

You can set the x - and y -axis window settings, as well as a number of other general graphing parameters on the View Window dialog box. This dialog box contains two tabs. The first tab lets you set the window values and steps used for graphing a field. The second tab contains parameters used for graphing solution curves, such as solution curve direction and independent variable(s).



Configuring Differential Equation Graph View Window Settings

• ClassPad Operation

- (1) Tap  and then [View Window], or tap .
 - This displays the View Window dialog box [Window] tab.
- (2) Input the required parameters on the [Window] and [Solutions] tabs.
 - For details about each setting, see “Differential Equation Graph View Window Parameters” on page 14-6-2.
- (3) After the settings are the way you want, tap [OK].



Differential Equation Graph View Window Parameters

■ Window Tab

Setting	Description
x_{\min}	minimum value along the (horizontal) x -axis
x_{\max}	maximum value along the (horizontal) x -axis
y_{\min}	minimum value along the (vertical) y -axis
y_{\max}	maximum value along the (vertical) y -axis
Field	for showing arrow, line or nothing
Steps	number of steps, or field lines, used for graphing a field

■ Variable Assignment

The variable assignments available on the Solutions tab vary depending on the graph type selected in the Graph Editor. Some graph types have preset assignments for the independent, x -axis, and y -axis variables. If the value is preset for the current graph type the value will still be displayed on the Solutions tab, but you will not be able to change it. The possible assignments for each graph type are shown in the tables below.

Graph Type	Setting	Possible Values
1 st -order Slope Field	Independent Variable	x or t
	x -Axis Variable	Same as independent variable
	y -Axis Variable	y
2 nd -order Phase Plane	Independent Variable	t
	x -Axis Variable	x
	y -Axis Variable	y
Nth-order	Independent Variable	x or t
	x -Axis Variable	independent variable or y_1 through y_{10}
	y -Axis Variable	independent variable or y_1 through y_{10}



■ Solutions Tab

Setting	Description
Solution Dir.	A solution curve is graphed starting at the initial condition value t_0 and continues until it reaches a target value, which can be either t_{\min} or t_{\max} . The solution direction determines the target values. Forward will graph the solution from t_0 to t_{\max} . Backward will graph the solution from t_0 to t_{\min} . Both will graph the solution from t_0 to t_{\min} , and then t_0 to t_{\max} .
Independent	Assignment of the independent variable for differential equations. The possible values are x or t . If you are graphing a phase plane you cannot choose the independent variable. It will automatically be set to t .
t_0 (or x_0)	If the independent variable is different from the x -axis variable then you can enter the initial value for the independent variable, unless you are graphing a slope field.
t_{\min} (or x_{\min})	If the independent variable is different from the x -axis variable then you can enter the minimum value for the independent variable.
t_{\max} (or x_{\max})	If the independent variable is different from the x -axis variable then you can enter the maximum value for the independent variable.
x -Axis	Assignment for the (horizontal) x -axis. If you are graphing a slope field or phase plane you will not be able to choose the x -axis variable but it will still be displayed in this dialog box.
y -Axis	Assignment for the (vertical) y -axis. If you are graphing a slope field or phase plane you will not be able to choose the y -axis variable but it will still be displayed in this dialog box.



14-7 Differential Equation Graph Window Operations

You can perform the following operations on the Differential Equation Graph window.

- Graph zooming and scrolling
- Modification of initial conditions (shifting the initial condition coordinates by dragging it)
- Configuring new initial conditions
- Tracing coordinates on a graph
- Graphing (slope field, phase plane, solution curves, general graphs) of an expression or value dragged from an eActivity application or Main application to the Differential Equation Graph window

Graph Zooming and Scrolling

You can use the menu commands and toolbar buttons shown below on the Differential Equation Graph window to zoom and scroll a graph.

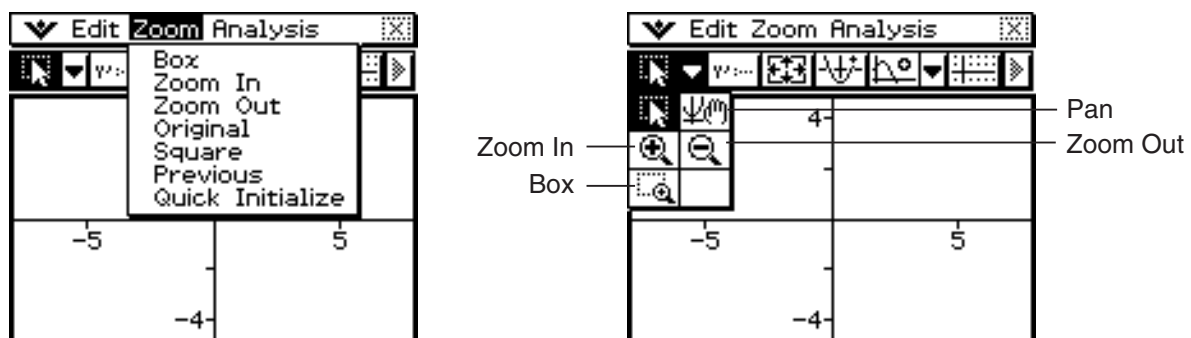

For details about these operations, see the applicable menu commands and toolbar buttons in “Chapter 3 Using the Graph&Table Application”.

Configuring and Modifying Initial Conditions

You can modify existing initial conditions and configure new initial conditions on the Differential Equation Graph window.

- **To modify an initial condition on the Differential Equation Graph window**

Example: Input the Nth-order differential equation and initial conditions, and then draw the solution curves. Next, modify an initial condition by dragging it on the Differential Equation Graph window.



(1) Perform the operation under “Inputting an Nth-order Differential Equation and Initial Conditions, and then Graphing the Solutions” on page 14-4-1.

- Performing all of the steps will produce a graph like the one shown below to appear on the Differential Equation Graph window.

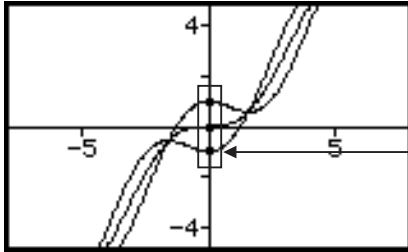

These dots are the currently configured initial conditions.

(2) Tap [Analysis] - [Select] or the toolbar  button.

(3) Tap one of the initial condition dots to select it.

- Here we will tap the bottom dot, which is the Initial Condition 1 setting $(x_i, y_{1i}, y_{2i}) = (0, -1, 0)$.

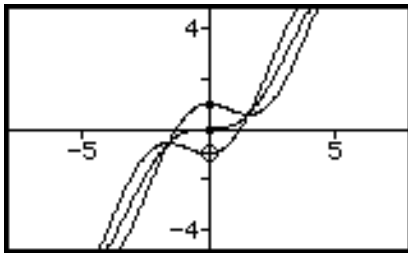

The dot you tap becomes a white circle (○), which indicates that it is selected.

(4) Use the stylus to drag the dot to another location.

- The applicable initial location will change to the coordinates of the location where you release the stylus after dragging the dot. After modifying an initial condition, the solution will be redrawn accordingly.

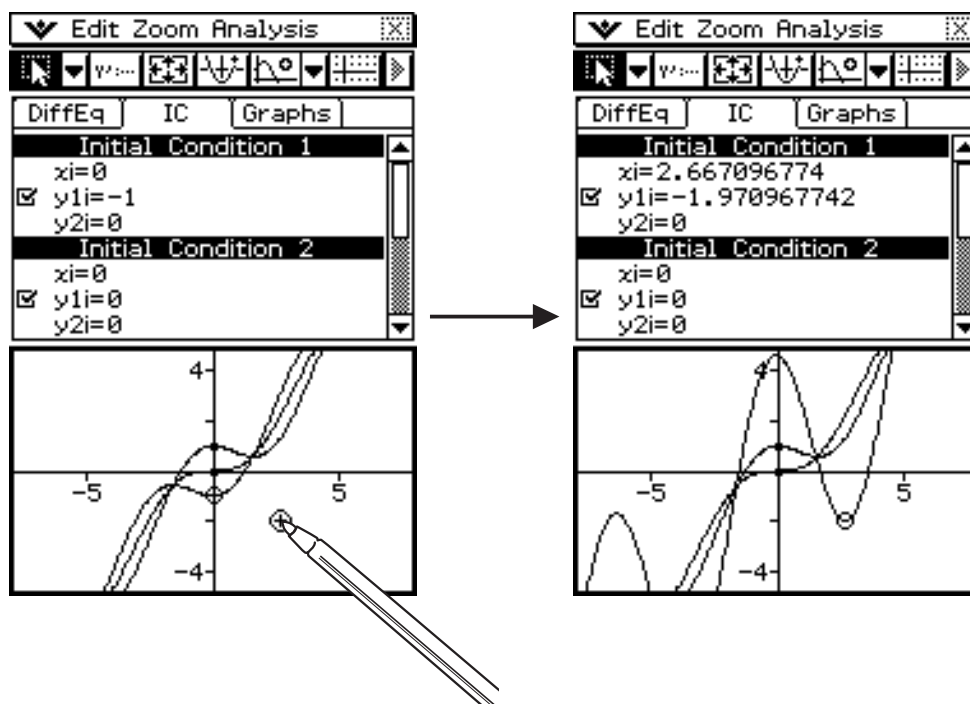



- To configure new initial conditions on the Differential Equation Graph window

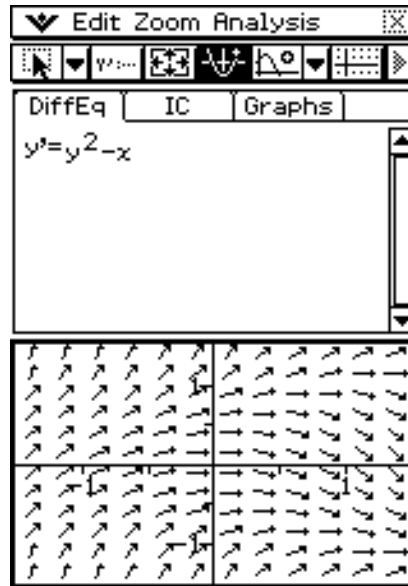

Example: After drawing the slope field of a first order differential equation, to configure initial condition settings on the Differential Equation Graph window

- (1) Perform the operation under “Inputting a First Order Differential Equation and Drawing a Slope Field” on page 14-2-1.
 - Performing all of the steps will produce a slope field like the one shown below to appear on the Differential Equation Graph window.

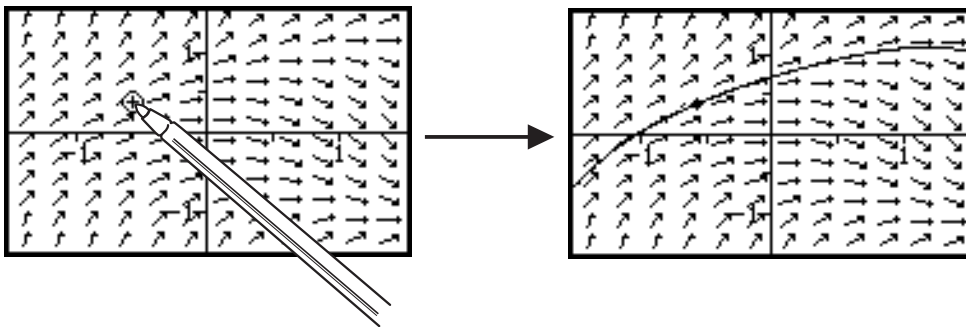

- (2) Tap [Analysis] - [Modify] or the toolbar  button.
 - This will cause the  button to become highlighted.
- (3) On the Differential Equation Graph window, tap the coordinates that you want to specify as the new initial condition.
 - This will set the coordinates as the new initial condition and draw a solution curve.



- After the solution curve is drawn,  button highlighting turns off, and the  button becomes highlighted. At this time, you can change the initial condition by tapping the dot that represents it and dragging the dot to a different location.

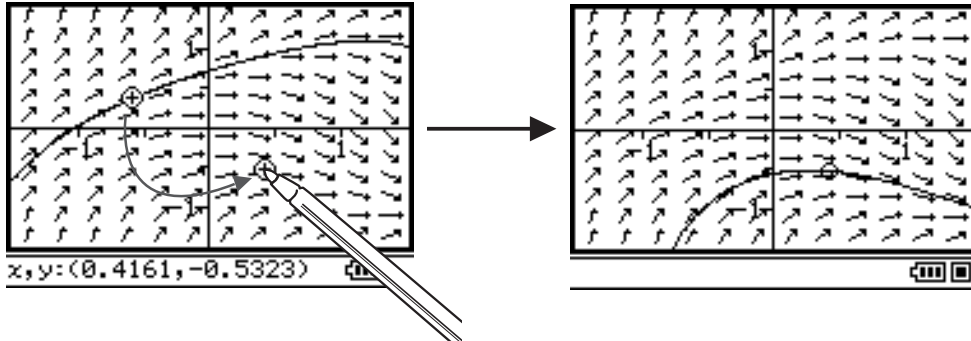

The procedure for modifying the initial condition is the same as steps 3 and 4 under “To modify an initial condition on the Differential Equation Graph window” on page 14-7-1.

- The newly configured initial condition is added to the initial condition editor. To view it, tap the [IC] tab.

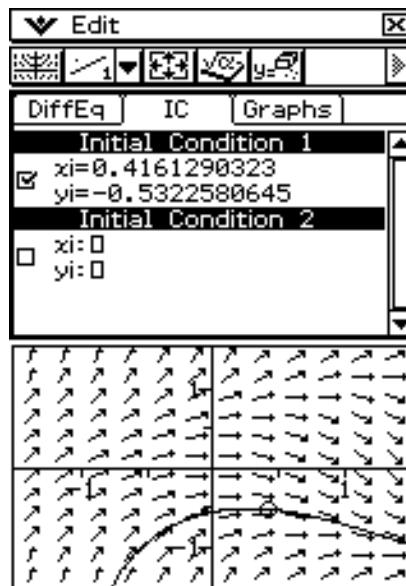

Using Trace to Read Graph Coordinates

The following three types of trace operations are available for reading graph coordinates.

Point Trace

Displays a trace cursor that can be positioned on any x, y coordinate. This trace cursor can be moved freely on the screen with either the stylus or cursor keys.



Field Trace

Displays a trace cursor that can be positioned on any grid point that has a field line. This trace cursor will snap to a field lines when moved with either the stylus or cursor keys.



Graph/Curve Trace

Displays a trace cursor that can be positioned on any graph or solution curve. This trace cursor will snap to a graph or curve when moved with either the stylus or cursor keys.

• To start a point trace

- (1) Make the Differential Equation Graph window active.
- (2) Tap .
 - This will cause the  button to become highlighted, and will display a crosshair pointer () in the center of the display. The coordinates of the crosshair pointer's location will be shown in the status bar.
- (3) To move the crosshair pointer around the display, tap the destination on the Differential Equation Graph window or use the cursor keys.
 - The coordinates in the status bar will change whenever the crosshair pointer is moved.

• To start a field trace

- (1) Draw a slope field or a phase plane.
 - See sections 14-2 and 14-3 for information about drawing a slope field or phase plane.
- (2) Tap .
 - This will cause the  button to become highlighted, and will display a crosshair pointer () near field line in the center of the display (in the center of the field line). The coordinates of the field cursor's location will be shown in the status bar.



- (3) To move the cross cursor to another field line, tap the destination on the Differential Equation Graph window or use the cursor keys.

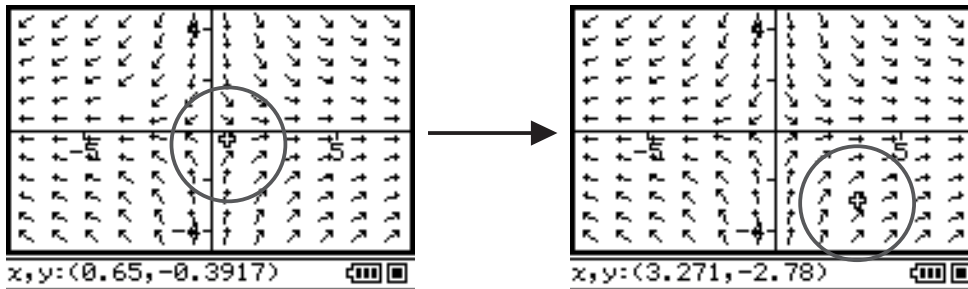



- The coordinates in the status bar will change whenever the crosshair pointer is moved.

• To perform a graph/curve trace operation

- (1) Draw a solution curve or general graph.

- See sections 14-2 through 14-5 for information about drawing.



- (2) Tap  or [Analysis] - [Trace].

- This will cause the  button to become highlighted, and will display a crosshair pointer () near the center of the display on the graph or solution curve. The coordinates of the field cursor's location will be shown in the status bar.

- (3) To move the crosshair pointer on the graph or solution curve, tap the destination on the Differential Equation Graph window or use the cursor keys.



- The coordinates in the status bar will change whenever the crosshair pointer is moved.

Tip

- When there are multiple graph or solution curves on the display, you can use the  and  cursor keys to move the crosshair pointer jump between graphs.

• To exit a trace operation

To exit an ongoing trace operation at any time, tap , or perform any one of the following menu or button operations.

[Analysis] - [Pan] () , [Analysis] - [Modify] () , [Zoom] - [Box] () , [Edit] - [Clear All]

Graphing an Expression or Value by Dropping it into the Differential Equation Graph Window

You can use the procedures in this section to graph an expression or value by dragging it from the eActivity application window or the Main application window and dropping it into the Differential Equation Graph window.

To draw this type of graph:	Drop this type of expression or value into the Differential Equation Graph window:
Slope field	1st-order differential equation in the form of $y' = f(x, y)$
Solution curve(s) of a 1st-order differential equation	Matrix of initial conditions in the following form: [[$x_1, y(x_1)$],[$x_2, y(x_2)$], ... [$x_n, y(x_n)$]] • Slope field must already have been graphed. If not, only points will be plotted and initial conditions are registered in the initial condition editor ([IC] tab).
Solution curve(s) of an Nth-order differential equation	1) Nth-order differential equation such as $y'' + y' + y = \sin(x)$, followed by 2) Matrix of initial conditions in the following form: [[$x_1, y1(x_1)$],[$x_2, y1(x_2)$], ... [$x_n, y1(x_n)$]] or [[$x_1, y1(x_1), y2(x_1)$],[$x_2, y1(x_2), y2(x_2)$], ... [$x_n, y1(x_n), y2(x_n)$]]
$f(x)$ type function graph	Function in the form $y = f(x)$

- To graph the slope field and solution curves by dropping a 1st-order differential equation and matrix into the Differential Equation Graph window

Example: To drag the 1st-order differential equation $y' = \exp(x) + x^2$ and then the initial condition matrix $[0, 1]$ from the eActivity application window to the Differential Equation Graph window, and graph the applicable slope field and solution curve

(1) On the application menu, tap .

- This starts up the eActivity application.

(2) On the eActivity application window, input the following expression and matrix.

$$y' = \exp(x) + x^2$$

$[0, 1]$

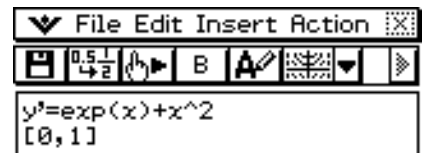

(3) From the eActivity application menu, tap [Insert], [Strip], and then [DiffEqGraph].

- This inserts a Differential Equation Graph data strip, and displays the Differential Equation Graph window in the lower half of the screen.

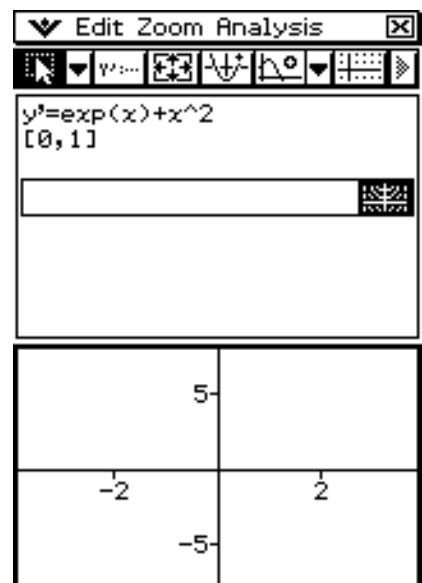

- (4) Drag the stylus across “ $y' = \exp(x) + x^2$ ” on the eActivity application window to select it.
- (5) Drag the selected expression to the Differential Equation Graph window.
- This draws the slope field of $y' = \exp(x) + x^2$ and registers the equation in the differential equation editor ([DiffEq] tab).

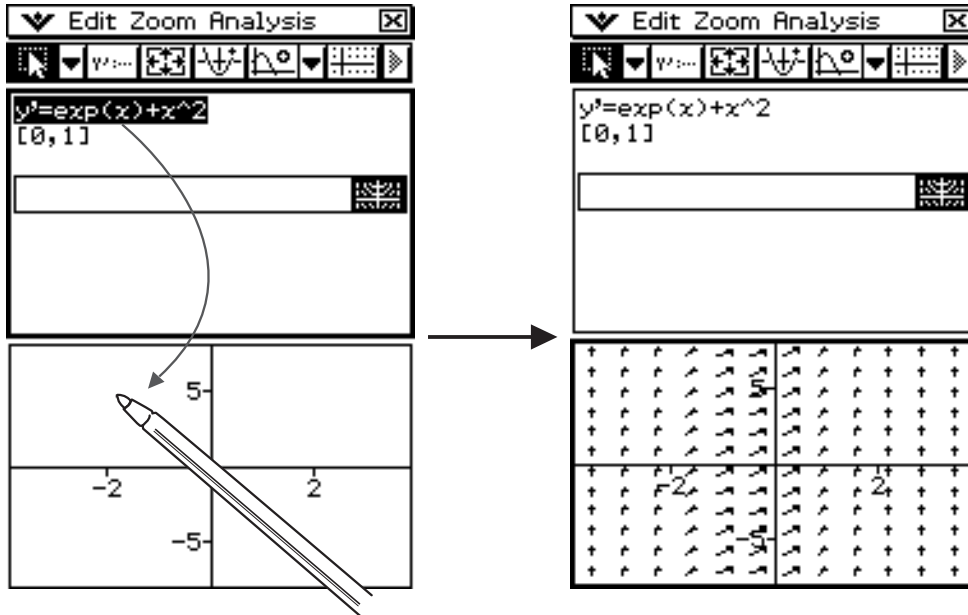

- (6) Drag the stylus across “[0,1]” on the eActivity application window to select it.
- (7) Drag the selected matrix to the Differential Equation Graph window.

- This graphs the solution curves of $y' = \exp(x) + x^2$ in accordance with the initial condition defined by the matrix and registers the initial condition in the initial condition editor ([IC] tab).

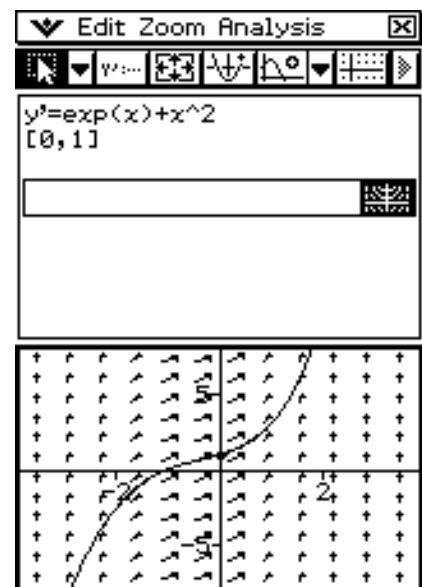

- To graph the solution curves by dropping an Nth-order differential equation and matrix into the Differential Equation Graph window

Example: To drag the Nth-order differential equation $y'' + y' = \exp(x)$ and then the initial condition matrix $[[0, 1, 0][0, 2, 0]]$ from the eActivity application window to the Differential Equation Graph window, and graph the applicable solution curves

(1) On the application menu, tap .

- This starts up the eActivity application.

(2) On the eActivity application window, input the following expression and matrix.

$$y'' + y' = \exp(x)$$

$$[[0, 1, 0][0, 2, 0]]$$



(3) From the eActivity application menu, tap [Insert], [Strip], and then [DiffEqGraph].

- This inserts a Differential Equation Graph data strip, and displays the Differential Equation Graph window in the lower half of the screen.

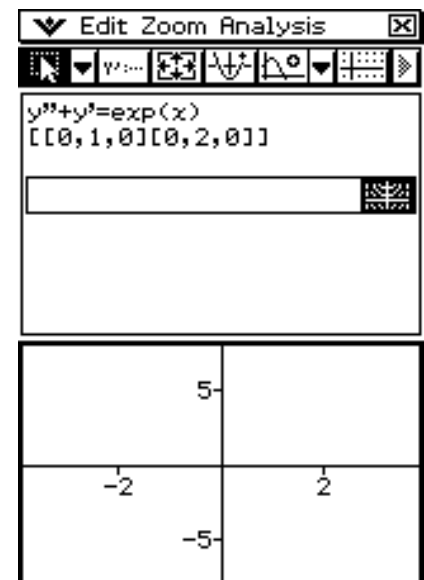

(4) Drag the stylus across " $y'' + y' = \exp(x)$ " on the eActivity application window to select it.



(5) Drag the selected expression to the Differential Equation Graph window.

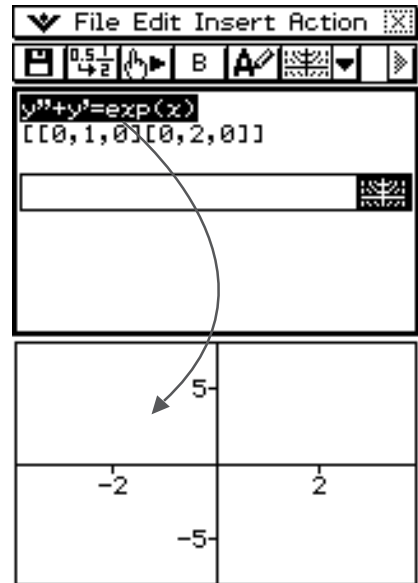

- This registers $y'' + y' = \exp(x)$ on the differential equation editor ([DiffEq] tab). The Differential Equation Graph window contents do not change at this time.

(6) Drag the stylus across "[[0,1,0][0,2,0]]" on the eActivity application window to select it.

(7) Drag the selected matrix to the Differential Equation Graph window.

- This graphs the solution curves of $y'' + y' = \exp(x)$ in accordance with the initial condition defined by the matrix, and registers the initial condition in the initial condition editor ([IC] tab).

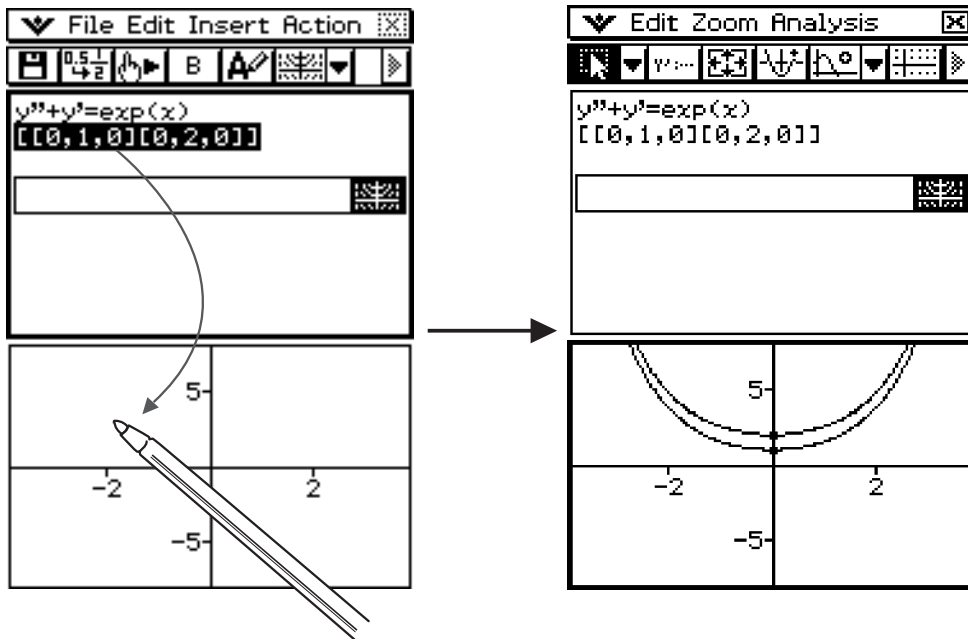

Tip

- An Nth-order differential equation of the form $f(y', y'', \dots, x)$ dropped into the Differential Equation Graph Window will be treated as $f(y', y'', \dots, x) = 0$.

Chapter 15

Using the Financial Application

This chapter explains how to use the Financial application. You can use the Financial application to perform a variety of financial calculations.

- 15-1 Financial Application Overview
- 15-2 Simple Interest
- 15-3 Compound Interest
- 15-4 Cash Flow
- 15-5 Amortization
- 15-6 Interest Conversion
- 15-7 Cost/Sell/Margin
- 15-8 Day Count
- 15-9 Depreciation
- 15-10 Bond Calculation
- 15-11 Break-even Point
- 15-12 Margin of Safety
- 15-13 Operating Leverage
- 15-14 Financial Leverage
- 15-15 Combined Leverage
- 15-16 Quantity Conversion

15

Important!

- Financial calculation rules and practices can differ according to country, geographic area, or financial institution. It is up to you to determine whether the calculation results produced by this calculator are compatible with the financial calculation rules that apply to you.

15-1 Financial Application Overview

This section explains how to use the Financial application initial screen, and describes the basic configuration of the Financial application windows. It also provides information on using the Financial application's Help and Format features.

Starting Up the Financial Application

Use the following procedure to start up the Financial application.

- **ClassPad Operation**

On the application menu, tap  Financial.

This starts the Financial application and displays the Financial application screen.

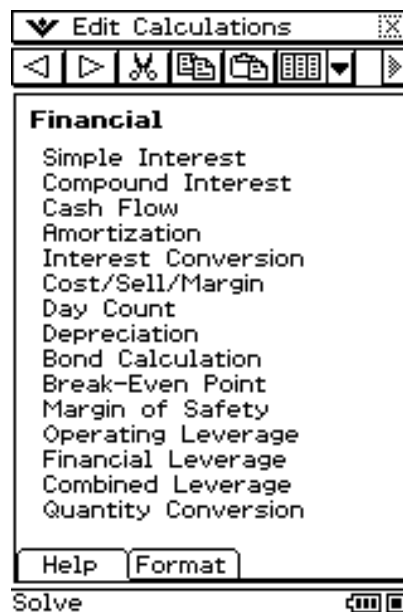

■ Financial Application Initial Screen

The screen shown below appears whenever you start up the Financial application when there are no pages from a previous session (page 15-1-5), or if you execute the [Edit] menu's "Clear All" command while the Financial application is running.



Financial Application Menus and Buttons

This section describes the basic configuration of Financial application windows, and provides basic information about its menus and commands.

- For information about the  menu, see “Using the  Menu” on page 1-5-4.

■ Edit Menu

To do this:	Select this Edit menu item:
Cut the currently selected value and place it onto the clipboard	Cut
Copy the currently selected value and place it onto the clipboard	Copy
Paste the current clipboard contents at the cursor location	Paste
Delete the currently selected value	Delete
Delete the currently displayed Financial application page	Delete Page
Clear all the values from the displayed Financial application page	Clear Page
Delete all the Financial application pages and display the Financial application initial screen	Clear All







■ Calculations Menu



To perform this type of calculation:	Select this Calculations menu item:
Interest without compounding based on the number of days money is invested	Simple Interest
Interest based on compounding parameters specified by you	Compound Interest
Value of money paid out or received in varying amounts over time	Cash Flow
Interest and principal portions of a payment or payments	Amortization
Effective or nominal interest rate for interest compounded multiple times during a year	Interest Conversion
Cost, selling price, or margin of profit on an item given the other two values	Cost/Sell/Margin
Number of days between two dates, or the date that is a specified number of days from another date	Day Count



To perform this type of calculation:	Select this Calculations menu item:
Amount that a business expense can be offset by income (depreciated) over a given year	Depreciation
Purchase price or annual yield of a bond	Bond Calculation
Amount you must sell to break even or to obtain a specified profit, as well as amount of profit or loss on particular sales	Break-Even Point
How much sales can be reduced before incurring losses	Margin of Safety
Degree of change in net earnings arising from a change in sales amount	Operating Leverage
Degree of change in net earning arising from a change in interest paid	Financial Leverage
Combined effects of operating and financial leverages	Combined Leverage
Number of items sold, selling price, or sales amount given other two values; number of items manufactured, unit variable cost, or total variable cost given other two values	Quantity Conversion

■ Toolbar Buttons

To do this:	Tap this button:
Scroll back through Financial application pages (page 15-1-5)	
Scroll forward through Financial application pages (page 15-1-5)	
Cut the currently selected value and place it onto the clipboard	
Copy the currently selected value and place it onto the clipboard	
Paste the current clipboard contents at the cursor location	
Open the Stat Editor window for Cash Flow calculations	
Open the Spreadsheet window for Cash Flow calculations	

- The  and  buttons are at the same location on the toolbar. If you cannot see the button you want, tap the down arrow next to the button and select the option you want from the list that appears.



Configuring Default Financial Application Settings

Most financial calculations require that you define certain general parameters that affect the results they produce. For example, you need to specify whether you use a 360-day or 365-day year, whether payments are made at the beginning of a period or end of a period, whether interest is compounded annually or semi-annually, etc.

With the Financial application, you use the Financial Format dialog box to configure default settings for financial calculations. Use the following procedure to display the Financial Format dialog box.

• ClassPad Operation

On the Financial application  menu, tap [Financial Format].

This will display the Financial Format dialog box.

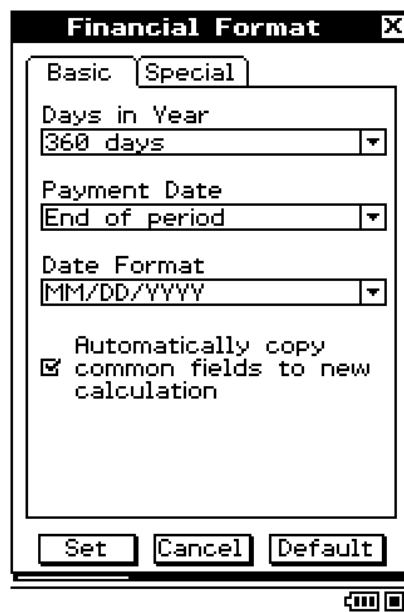

Note that this window has two tabs: Basic and Special. Tap a tab to display its contents and then configure the settings you want. To configure a setting, tap the down arrow button next to it and then select the setting you want from the list that appears.



Tip

- The settings you should configure depend on the legal requirements in your area, financial conventions, your particular needs, etc.
- After configuring your settings, tap [Set] to apply them. Tap [Cancel] to close the window without changing any settings. Tap [Default] to restore all the settings of the Financial Format dialog box to their initial defaults.
- For details about each of the setting items, see “Financial Format Dialog Box” (page 1-9-12).

Financial Application Pages

Selecting a calculation type from the Financial application [Calculations] menu will create and display a new “page”.

Note the following rules that apply to Financial application pages.

- You can scroll between pages using the toolbar  and  buttons.
- Selecting the same calculation type as the calculation on the currently displayed (original) page will create a new page that is a duplicate of the original page. You can then change the values in the new page without affecting the values of the original page.
- Selecting a different calculation type as the calculation on the currently displayed (original) page will create a new page that contains the applicable fields for the selected calculation. Any fields on the new page that are also on the original page will contain the same value as the corresponding field on the original page.
- If the currently displayed page is part way through a series of pages that are in memory, selecting a calculation from the [Calculations] menu will create a new page in the series and delete everything after it. If you select a new calculation while page 3 of 5 is displayed, for example, the newly created page will become 4 of 4.
- To delete particular page, display it and then select “Clear Page” on the [Edit] menu.
- To delete all pages, select “Clear All” on the [Edit] menu while any page is displayed.
- Financial application pages remain in memory until you delete them as described above.



Financial Calculation Screen Basics

Each calculation has a unique screen format.

This section provides general information that applies to the screens for all Financial application calculations.

Compound Interest

N	4	Input/calculation box
I%	6	Input values when required. For calculation, tap the button to the left of the box.
PV	-1000	
PMT	0	
FV	1262.47696	
P/Y	1	Input box
C/Y	1	Input values in the box.

Help tab — Tap to display help about the box where the cursor is located.

Format tab — Tap to display a tab for modifying financial calculation default settings (page 15-1-4) that apply to the current calculation.

Status Bar — Tap the status bar to change the format or solve a calculation.

- While the cursor is located in a calculation box, you can press the calculator's **EXE** key to perform the calculation instead of tapping the button next to the box. Alternatively, you can tap "Solve" in the status bar to perform the calculation.

■ Help Tab

Tapping the [Help] tab at the bottom of a financial calculation screen will display help about the box where the cursor is currently located. You can leave the [Help] tab displayed, and its text will change each time you move the cursor from one box to another.

The [Help] tab also explains why a calculation cannot be performed if you tap a calculation button premature.

To close the [Help] tab, tap it again.

■ Format Tab

Tapping the [Format] tab at the bottom of a financial calculation screen will display all of the default financial calculation settings (page 15-1-4) that apply to the currently displayed calculation. You can use the [Format] tab to change the settings, if you want.

To close the [Format] tab, tap it again.

■ Status Bar

The status bar shows the settings that apply to the calculations on the currently active page. You can change the settings by tapping them on the status bar. If the cursor is in an input/calculation box, “Solve” will appear on the left side of the status bar. You can tap this to complete this calculation instead of tapping the box to the left of the input/calculation box.

Variables

The following sections explain how to perform each of the Financial application calculations found on the [Calculations] menu.



15-2 Simple Interest

Simple Interest lets you calculate interest (without compounding) based on the number of days money is invested.

Simple Interest Fields

The following fields appear on the Simple Interest calculation page.

Field	Description
Days	Number of days in investment period
I%	Annual interest rate (as a percent)
PV	Present value (initial investment)
SI	Calculates and displays simple interest
SFV	Calculates and displays simple future value (principal + interest)

Financial Application Default Setup for Examples

You can use the [Format] tab to change the following setting.

Days in Year: 365 days

■ Example 1

What is the final value ([SFV]) after five years (1,825 days) of a \$300 investment (PV) earning 6.0% simple interest (I%)?

- (1) Tap [Calculations] and then [Simple Interest].
- (2) Input 1825 (or 5×365) for Days.
- (3) Input 6 for I%.
- (4) Input -300 for PV.
- (5) Tap the [SFV] button.
 - This indicates a final value of \$390.

Tip

- Tapping the [SI] button shows the interest earned.
- To find the interest earned on \$3,000 instead of \$300, change -300 to -3000 and tap the [SI] button again.

■ Example 2

What is the simple interest ([SI]) on a principal amount of \$10,000 (PV) invested or borrowed for 120 days (Days) at 5% per annum ($I\%$)?

The screenshot shows a calculator window titled "Edit Calculations" with a toolbar at the top. The main display area is titled "Simple Interest" and contains the following fields:

Days	120
I%	5
PV	-10000
[SI]	164.3835616
[SFV]	10164.38356

At the bottom of the window, there are buttons for "Help" and "Format", and a status bar showing "Solve 365".

- This indicates that the simple interest is \$164.3835616.

Calculation Formulas

365-day Mode $SI' = \frac{\text{Dys}}{365} \times PV \times i \quad \left(i = \frac{I\%}{100} \right)$

360-day Mode $SI' = \frac{\text{Dys}}{360} \times PV \times i \quad \left(i = \frac{I\%}{100} \right)$

$$SI = -SI'$$

$$SFV = -(PV + SI')$$



15-3 Compound Interest

Compound Interest lets you calculate interest based on compounding parameters you specify.

Compound Interest Fields

The following fields appear on the Compound Interest calculation page.

Field	Description
N	Number of installment periods
I%	Annual interest rate (as a percent)
PV	Present value (initial investment)
PMT	Amount paid each period
FV	Future value
P/Y	Number of installment periods per year
C/Y	Number of times interest is compounded per year

Financial Application Default Setup for Examples

You can use the [Format] tab to change the following settings.

Odd Period: Compound (CI)

Payment Date: End of period

Tip

- You can look at the status bar to see if it displays “CI” and “End”. If those are not displayed, you can tap the status bar to switch the settings.

■ Example 1

What is the future value (FV) on a principal amount of \$1,000 ($PV = -1000$) invested or borrowed for four years at 6% per annum, compounded yearly ($C/Y = 1$)? The entire payment is due at the end of three years so the amount paid each year (PMT) is 0 and the number of installment periods per year (P/Y) can be 1.

The screenshot shows a calculator interface titled "Compound Interest". It has a toolbar at the top with various icons. Below the toolbar, the fields are as follows:

N	4
I%	6
PV	-1000
PMT	0
FV	1262.47696
P/Y	1
C/Y	1

At the bottom of the screen, there are buttons for "Help" and "Format", and a status bar displaying "Solve CI End".

■ **Example 2**

If you deposit \$100 into an account that earns 7% compounded monthly, how much will be in the account after three years?

Edit Calculations	
Compound Interest	
N	36
I%	7
PV	-100
PMT	0
FV	123.2925587
P/Y	12
C/Y	12
▲Help Format	
Solve	CI End

■ **Example 3**

What will be the value of an ordinary annuity at the end of 10 years if \$100 is deposited each month into an account that earns 7% compounded monthly?

Edit Calculations	
Compound Interest	
N	120
I%	7
PV	0
PMT	-100
FV	17308.48074
P/Y	12
C/Y	12
▲Help Format	
Solve	CI End

Calculation Formulas

- **PV, PMT, FV, n**

$$\begin{aligned} \underline{I\% \neq 0} \quad PV &= \frac{-\alpha \times PMT - \beta \times FV}{\gamma} \\ PMT &= \frac{-\gamma \times PV - \beta \times FV}{\alpha} \\ FV &= \frac{-\gamma \times PV - \alpha \times PMT}{\beta} \\ n &= \frac{\log \left\{ \frac{(1+iS) \times PMT - FV \times i}{(1+iS) \times PMT + PV \times i} \right\}}{\log(1+i)} \end{aligned}$$

I% = 0

$$\begin{aligned} PV &= -(PMT \times n + FV) \\ PMT &= -\frac{PV + FV}{n} \\ FV &= -(PMT \times n + PV) \\ n &= -\frac{PV + FV}{PMT} \end{aligned}$$

$$\begin{aligned} \alpha &= (1+i \times S) \times \frac{1-\beta}{i} \\ \beta &= \begin{cases} (1+i)^{-n} & \dots\dots\dots \text{Off (Format tab)} \\ (1+i)^{-Intg(n)} & \dots\dots\dots \text{CI or SI (Format tab)} \end{cases} \\ \gamma &= \begin{cases} 1 & \dots\dots\dots \text{Off (Format tab)} \\ (1+i)^{Frac(n)} & \dots\dots\dots \text{CI (Format tab)} \\ 1+i \times Frac(n) & \dots\dots\dots \text{SI (Format tab)} \end{cases} \\ S &= \begin{cases} 0 & \dots\dots\dots \text{Payment : End (Format tab)} \\ 1 & \dots\dots\dots \text{Payment : Begin (Format tab)} \end{cases} \\ i &= \begin{cases} \frac{I\%}{100} & \dots\dots\dots (P/Y = C/Y = 1) \\ \left(1 + \frac{I\%}{100 \times [C/Y]}\right)^{\frac{C/Y}{P/Y}} - 1 & \dots\dots\dots \text{(Other than those above)} \end{cases} \end{aligned}$$

- **I%**

i (effective interest rate)

i (effective interest rate) is calculated using Newton's Method.
 $\gamma \times PV + \alpha \times PMT + \beta \times FV = 0$

To I% from i (effective interest rate)

$$I\% = \begin{cases} i \times 100 & \dots\dots\dots (P/Y = C/Y = 1) \\ \left\{ \left(1+i\right)^{\frac{P/Y}{C/Y}} - 1 \right\} \times C/Y \times 100 & \dots\dots\dots \text{(Other than those above)} \end{cases}$$

Tip

- Interest (I%) calculations are performed using Newton's Method, which produces approximate values whose precision can be affected by various calculation conditions. Interest calculation results produced by this application should be used keeping the above in mind, or results should be confirmed separately.

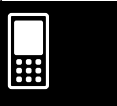

15-4 Cash Flow

Cash Flow lets you calculate the value of money paid out or received in varying amounts over time.

Cash Flow Fields

The following fields appear on the Cash Flow calculation page.

Field	Description
Cash	List of income or expenses (up to 80 entries)
I%	Annual interest rate (as a percent)
NPV	Net present value
IRR	Interest rate of return
PBP	Payback period
NFV	Net future value





Inputting Cash Flow Values

Cash flow calculations require that you input a list of cash flow values for multiple periods. The following shows the cash flow values used in the examples of this section, and the procedure you should use to input them.

■ Cash Flow Values

Period	Cash Flow
0	0
1	100
2	200
3	300
4	400
5	500

● To input cash flow values from the Cash Flow calculation page

- (1) On the Financial application toolbar, tap .
 - This will open the Stat Editor window in the lower half of the display.
 - The  icon shares the same location on the toolbar as the  icon. If you see the  icon, tap the down arrow button to the right of it and then tap  on the menu that appears.
- (2) In cells 1 through 6 under “list1”, input the cash flow values.
- (3) Tap the “Cash” field (which currently shows “<empty>”).



(4) On the dialog box that appears, make sure “list1” is selected for “List variables”, and then tap [OK].

- You can now use the list of values in cash flow calculation.
- To close the Stat Editor window, tap anywhere in the Stat Editor window and then tap the close box (✕) in the upper right corner of the screen.
- For details about using the Stat Editor and about the list variables, see “7-2 Using Stat Editor”.

■ Example 1

How much should you be willing to pay (NPV) for an investment with a specific cash flow (Cash), if your required rate of return ($I\%$) is 10% per year?

Edit Calculations

Cash Flow

Cash: 6 entries

I%: 10

NPV: 1065.258831

IRR:

▲Help Format

	list1	list2	list3
1	0		
2	100		
3	200		
4	300		
5	400		

Cal▶

[7] =

Solve

■ Example 2

Suppose you were offered the investment in Example 1 at a cost of \$1,000. What is the net present value (NPV) of the investment? What is the internal rate of return (IRR)?

Note

- When performing the calculations for Example 2, you need to enter the cost, as a negative value (–1000), in cell 1 of list1 in the stat editor. After that tap the “Cash” field. On the dialog box that appears, make sure “list1” is selected for “List variables”, and then tap [OK]. After that you can tap [NPV] and [IRR] to obtain the required values.
- To close the Stat Editor window, tap anywhere in the Stat Editor window and then tap the close box (✕) in the upper right corner of the screen.

Edit Calculations

Cash Flow

Cash: 6 entries

I%: 10

NPV: 65.25883105

IRR: 12.00576195

▲Help Format

	list1	list2	list3
1	-1000		
2	100		
3	200		
4	300		
5	400		

Cal▶

[2]=100

Solve

Calculation Formulas

- **NPV**

$$NPV = CF_0 + \frac{CF_1}{(1+i)} + \frac{CF_2}{(1+i)^2} + \frac{CF_3}{(1+i)^3} + \dots + \frac{CF_n}{(1+i)^n} \quad \left(i = \frac{I\%}{100}\right)$$

n : natural number up to 79

- **NFV**

$$NFV = NPV \times (1+i)^n$$

- **IRR**

IRR is calculated using Newton's Method.

$$0 = CF_0 + \frac{CF_1}{(1+i)} + \frac{CF_2}{(1+i)^2} + \frac{CF_3}{(1+i)^3} + \dots + \frac{CF_n}{(1+i)^n}$$

In this formula, $NPV = 0$, and the value of *IRR* is equivalent to $i \times 100$. It should be noted, however, that minute fractional values tend to accumulate during the subsequent calculations performed automatically by the calculator, so *NPV* never actually reaches exactly zero. *IRR* becomes more accurate the closer that *NPV* approaches to zero.

- **PBP**

$$PBP = \begin{cases} 0 & \dots\dots\dots (CF_0 \geq 0) \\ n - \frac{NPV_n}{NPV_{n+1} - NPV_n} & \dots \text{(Other than those above)} \end{cases}$$

$$NPV_n = \sum_{k=0}^n \frac{CF_k}{(1+i)^k}$$

n : Smallest positive integer that satisfies the conditions $NPV_n \leq 0$, $NPV_{n+1} \geq 0$, or 0.



15-5 Amortization

Amortization lets you calculate the interest and principal portions of a payment or payments.

Amortization Fields

The following fields appear on the Amortization calculation page.

Field	Description
PM1	Number of first installment period in interval under consideration
PM2	Number of last installment period in interval under consideration
I%	Annual interest rate (as a percent)
PV	Present value (initial investment)
PMT	Amount paid each period
P/Y	Number of installment periods per year
C/Y	Number of times interest is compounded per year
BAL	Balance of principal after PM2
INT	Interest portion of PM1
PRN	Principal portion of PM1
sumINT	Total interest paid from PM1 to PM2 (inclusive)
sumPRN	Total principal paid from PM1 to PM2 (inclusive)

Financial Application Default Setup for Examples

You can use the [Format] tab to change the following setting.

Payment Date: End of period

Important!

- The calculation for Example 1 is performed using a Compound Interest page. The payment result you obtain here will be used for the Amortization page calculations in Example 2.



■ Example 1 (Compound Interest)

Use a Compound Interest page (page 15-3-1) to determine the monthly payment ([PMT]) on a 20-year ($N = 20 \times 12 = 240$) mortgage with a loan amount (PV) of \$100,000 at an annual rate ($I\%$) of 8.025%, compounded monthly ($C/Y = 12$). There are 12 payment periods per year (P/Y). Be sure to input zero for the future value (FV), which indicates that the loan will be completely paid off at the end of 20 years (240 months).

Compound Interest	
N	240
I%	8.025
PV	100000
PMT	-837.9966279
FV	0
P/Y	12
C/Y	12

▲Help Format

Solve CI End



■ Example 2 (Amortization)

Use the monthly payment value you obtained in Example 1 ($PMT = -837.9966279$) to determine the following information for payment 10 (PM1) through 15 (PM2).

As in Example 1, the mortgage has a loan amount (PV) of \$100,000 at an annual rate ($I\%$) of 8.025%, compounded monthly ($C/Y = 12$) for 20 years.

There are 12 payment periods per year (P/Y).

- The balance (BAL) of the principal remaining after payment 15
- The interest amount (INT) included in payment 10
- The principal amount (PRN) included in payment 10
- Total interest to be paid (sumINT) from payment 10 to payment 15
- Total principal to be paid (sumPRN) from payment 10 to payment 15

▼ Edit Calculations	
<div style="display: flex; justify-content: space-between;"> ◀ ▶ ✂ 📄 📁 📊 ▼ ▶ </div>	
Amortization	
PM1	10
PM2	15
I%	8.025
PV	100000
PMT	-837.9966279
P/Y	12
C/Y	12
BAL	97338.94362
INT	-658.286684
PRN	-179.709944
ΣINT	-3931.531399
ΣPRN	-1096.448368
<div style="display: flex; justify-content: space-between;"> ▲Help Format </div>	
Solve End ⏪ ⏩	



Calculation Formulas

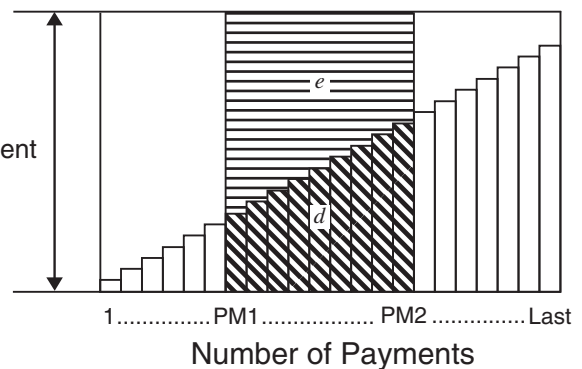
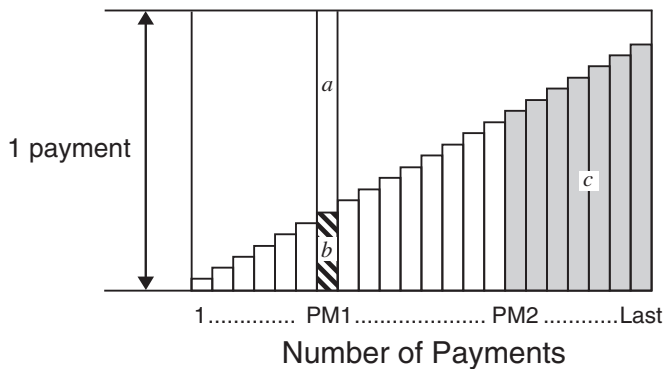

a: Interest portion of payment PM1 (INT)

$$INT_{PM1} = |BAL_{PM1-1} \times i| \times (PMT \text{ sign})$$

b: Principal portion of payment PM1 (PRN)

$$PRN_{PM1} = PMT + BAL_{PM1-1} \times i$$

c: Principal balance upon completion of payment PM2 (BAL)

$$BAL_{PM2} = BAL_{PM2-1} + PRN_{PM2}$$

d: Total principal paid from payment PM1 to payment PM2 (ΣPRN)

$$\sum_{PM1}^{PM2} PRN = PRN_{PM1} + PRN_{PM1+1} + \dots + PRN_{PM2}$$

e: Total interest paid from payment PM1 to payment PM2 (ΣINT)

• $a + b =$ one repayment (PMT)

$$\sum_{PM1}^{PM2} INT = INT_{PM1} + INT_{PM1+1} + \dots + INT_{PM2}$$

$BAL_0 = PV$ Payment: End (Format tab)

$INT_1 = 0, PRN_1 = PMT$... Payment: Begin (Format tab)

Converting between the Nominal Interest Rate and Effective Interest Rate

The nominal interest rate ($I\%$ value input by user) is converted to an effective interest rate ($I\%'$) for installment loans where the number of annual payments is different from the number of annual compoundings calculation periods.

$$I\%' = \left\{ \left(1 + \frac{I\%}{100 \times [C/Y]} \right)^{\frac{[C/Y]}{[P/Y]}} - 1 \right\} \times 100$$

The following calculation is performed after conversion from the nominal interest rate to the effective interest rate, and the result is used for all subsequent calculations.

$$i = I\%' \div 100$$



15-6 Interest Conversion

Interest Conversion lets you calculate the effective or nominal interest rate for interest that is compounded multiple times during a year.

Interest Conversion Fields

The following fields appear on the Interest Conversion calculation page.

Field	Description
N	Number of times interest is compounded per year
EFF	Effective interest rate (as a percent)
APR	Nominal interest rate (as a percent)

■ Example 1

What is the annual effective interest rate ([EFF]) on a certificate that offers a nominal interest rate of 3% ([APR]), compounded quarterly (N = 4)?

The screenshot shows a window titled "Edit Calculations" with a toolbar containing navigation and editing icons. The main area is titled "Interest Conversion" and contains three input fields: "N" with the value "4", "EFF" with the value "3.033919066", and "APR" with the value "3". At the bottom of the window are "Help" and "Format" buttons, and a "Solve" button with a calculator icon.

■ Example 2

What is the nominal interest rate ([APR]) on a certificate that offers an annual effective interest rate ([EFF]) of 5%, compounded bi-monthly (N = 6)?

Interest Conversion	
N	6
EFF	5
APR	4.898907631

▲Help Format

Solve

Tip

- You can change any value and then tap a button to recalculate.

Calculation Formulas

$$EFF = \left[\left(1 + \frac{APR/100}{n} \right)^n - 1 \right] \times 100$$

$$APR = \left[\left(1 + \frac{EFF}{100} \right)^{\frac{1}{n}} - 1 \right] \times n \times 100$$



15-7 Cost/Sell/Margin

Cost/Sell/Margin lets you calculate the cost, selling price, or margin of profit on an item, given the other two values.

Cost/Sell/Margin Fields

The following fields appear on the Cost/Sell/Margin calculation page.

Field	Description
Cost	Production cost
Sell	Selling price
Margin	Margin of profit (portion of selling price not absorbed by cost of production)

■ Example

What is the selling price ([Sell]) required to obtain a margin of profit ([Margin]) of 60% on an item that cost \$40 ([Cost])?

The screenshot shows a calculator interface titled "Edit Calculations". Inside, there is a section titled "Cost/Sell/Margin" with three input fields: "Cost" (40), "Sell" (100), and "Margin" (60). At the bottom of the interface, there are buttons for "Help", "Format", and "Solve".

Tip

- Any of the values on this page can be calculated by inputting values for the other two, and then tapping the button for the value you want to obtain.

Calculation Formulas

$$CST = SEL \left(1 - \frac{MRG}{100}\right)$$

$$SEL = \frac{CST}{1 - \frac{MRG}{100}}$$

$$MRG(\%) = \left(1 - \frac{CST}{SEL}\right) \times 100$$

15-8 Day Count

Day Count lets you calculate the number of days between two dates, or the date that is a specified number of days from another date.

Day Count Fields

The following fields appear on the Day Count calculation page.

Field	Description
d1	Month (1-12); Day (1-31); Year (1902-2097)
d2	Month (1-12); Day (1-31); Year (1902-2097)
Days	Number of days from d1 to d2

Financial Application Default Setup for Examples

You can use the [Format] tab to change the following setting.

Days in Year: 365 days

Important!

- The format used for the date on the Day Count screen is the one you select under “Configuring Default Financial Application Settings” on page 15-1-4.
- Calculating the date that is a specified number of days from another date is valid only when Days in Year is set to 365.

■ Example 1

How many days ([Days]) are there from March 3, 2005 (d1) to June 11, 2005 (d2)?

Day Count

d1 3 / 3 / 2005

d2 6 / 11 / 2005

Days 100

d2 = d1+Days

d1 = d2-Days

▲Help Format

Solve 365

Tip

- Pressing **EXE** after inputting a value advances to the next field.

■ Example 2

What date (d2) comes 150 days ([Days]) after June 11, 2005 (d1)?

Edit Calculations

Day Count

d1 6 / 11 / 2005

d2 11 / 8 / 2005

Days 150

d2 = d1+Days

d1 = d2-Days

Help Format

Solve 365

■ Example 3

What date (d1) comes 44 days ([Days]) before March 3, 2005 (d2)?

Edit Calculations

Day Count

d1 1 / 18 / 2005

d2 3 / 3 / 2005

Days 44

d2 = d1+Days

d1 = d2-Days

Help Format

Solve 365

15-9 Depreciation

Depreciation lets you calculate the amount that a business expense can be offset by income (depreciated) over a given year.

You can use a Depreciation page to calculate depreciation using one of four methods: straight-line, fixed-percentage, sum-of-the-years'-digits, or declining-balance.

Depreciation Fields

The following fields appear on the Depreciation calculation page.

Field	Description
N	Number of years over which depreciation occurs
<i>I</i> %	Annual interest rate (as a percent)
PV	Present value (initial investment)
FV	Future value
<i>j</i>	Year for which depreciation is being calculated
YR1	Number of depreciable months in first year
SL	Calculate depreciation for year <i>j</i> using the straight-line method
FP	Calculate depreciation for year <i>j</i> using the fixed-percentage method
SYD	Calculate depreciation for year <i>j</i> using the sum-of-the-years'-digits method
DB	Calculate depreciation for year <i>j</i> calculated using the declining-balance method
RDV	Residual value after depreciation for year <i>j</i>



■ Example 1

Use the sum-of-the-years'-digits method ([SYD]) to calculate the first year ($j = 1$) of depreciation on an \$12,000 (PV) computer, with a useful life (N) of five years. Use a depreciation ratio ($I\%$) of 25%, and assume that the computer can be depreciated for a full 12 months in the first year (YR1).

Depreciation	
N	5
I%	25
PV	12000
FV	0
j	1
YR1	12
SL	
FP	
SYD	4000
DB	
RDV	8000

Help ▲Format

Solve

Tip

- At the end of the useful life the value of the computer will be 0, so we enter 0 in the FV field.



■ Example 2

Now calculate the depreciation amount ([SYD]) for the second year ($j = 2$).

Depreciation	
N	5
I%	25
PV	12000
FV	0
j	2
YR1	12
[SL]	
[FP]	
[SYD]	3200
[DB]	
RDV	4800

▼Help Format

Calculate depreciation for year j using the sum-of-the-years'-digits

Solve

Note

- You can also tap [SL] to calculate depreciation using straight-line method, [FP] using fixed-percentage method, or [DB] using declining-balance method.
- Each depreciation method will produce a different residual value after depreciation (RDV) for the applicable year (j).

Calculation Formulas

■ Straight-Line Method

$$SL_1 = \frac{(PV-FV)}{n} \times \frac{YR1}{12}$$

$$SL_j = \frac{(PV-FV)}{n}$$

$$SL_{n+1} = \frac{(PV-FV)}{n} \times \frac{12-YR1}{12}$$

($YR1 \neq 12$)

■ Fixed-Percentage Method

$$FP_1 = PV \times \frac{I\%}{100} \times \frac{YR1}{12}$$

$$FP_j = (RDV_{j-1} + FV) \times \frac{I\%}{100}$$

$$FP_{n+1} = RDV_n \quad (YR1 \neq 12)$$

$$RDV_1 = PV - FV - FP_1$$

$$RDV_j = RDV_{j-1} - FP_j$$

$$RDV_{n+1} = 0 \quad (YR1 \neq 12)$$

■ Sum-of-the-Years'-Digits Method

$$Z = \frac{n(n+1)}{2}$$

$$n' = n - \frac{YR1}{12}$$

$$Z' = \frac{(Intg(n') + 1)(Intg(n') + 2 \times Frac(n'))}{2}$$

$$SYD_1 = \frac{n}{Z} \times \frac{YR1}{12} (PV - FV)$$

$$SYD_j = \left(\frac{n' - j + 2}{Z'} \right) (PV - FV - SYD_1) \quad (j \neq 1)$$

$$SYD_{n+1} = \left(\frac{n' - (n+1) + 2}{Z'} \right) (PV - FV - SYD_1) \times \frac{12 - YR1}{12} \quad (YR1 \neq 12)$$

$$RDV_1 = PV - FV - SYD_1$$

$$RDV_j = RDV_{j-1} - SYD_j$$

■ Declining-Balance Method

$$DB_1 = PV \times \frac{I\%}{100n} \times \frac{YR1}{12}$$

$$RDV_1 = PV - FV - DB_1$$

$$DB_j = (RDV_{j-1} + FV) \times \frac{I\%}{100n}$$

$$RDV_j = RDV_{j-1} - DB_j$$

$$DB_{n+1} = RDV_n \quad (YR1 \neq 12)$$

$$RDV_{n+1} = 0 \quad (YR1 \neq 12)$$



15-10 Bond Calculation

Bond Calculation lets you calculate the purchase price or the annual yield of a bond.

Bond Calculation Fields

The following fields appear on the Bond Calculation page.

Field	Description
d1	Month (1-12); Day (1-31); Year (1902-2097)
d2	Month (1-12); Day (1-31); Year (1902-2097)
N	Number of periods
RDV	Redemption value
CPN	Annual coupon rate
PRC	Price of bond
YLD	Yield to maturity (as a percent)
INT	Interest accumulated during partial year portion of investment period
Cost	Cost of bond (price plus partial year interest)

Financial Application Default Setup for Examples

You can use the [Format] tab to change the following settings.

Days in Year: 360 days

Compounding Frequency: Semi-annual

Bond Interval: Date



■ Example 1

You want to purchase a semiannual (Compounding Frequency = Semi-annual) corporate bond that matures on 12/15/2006 (d2) to settle on 6/1/2004 (d1). The bond is based on the 30/360 day-count method (Days in Year = 360 days) with a coupon rate (CPN) of 3%. The bond will be redeemed at 100% of its par value (RDV). For 4% yield to maturity (YLD), calculate the bond's price ([PRC]) and accrued interest (INT).

- Before performing the calculation, you should use the [Format] tab to change the [Bond Interval] setting to "Date" and the [Compounding Frequency] to "Semi-annual".
- You can also look at the status bar to see if the settings are correct. If they are not, tap the settings in the status bar to switch to the correct ones.

Edit Calculations	
Bond Calculation	
d1	6 / 1 / 2004
d2	12 / 15 / 2006
N	5
RDV	100
CPN	3
PRC	-97.60735355
YLD	4
INT	-1.383333333
Cost	-98.99068689
<input type="button" value="Help"/> <input type="button" value="Format"/>	
Solve 360 Semi Date	



■ Example 2

For the same type of bond described in Example 1, calculate the price on the bond (PRC) based on a specific number of coupon payments (Term).

- Before performing the calculation, you should use the [Format] tab to change the [Bond Interval] setting to “Term”, or tap “Date” in the status bar.

The bond is based on the 30/360 day-count method (Days in Year = 360 days) with a coupon rate (CPN) of 3%. The bond will be redeemed at 100% of its par value (RDV) after 3 periods (N). For 4% yield to maturity (YLD), calculate the bond’s price ([PRC]).

Edit Calculations

Bond Calculation

d1 / /

d2 / /

N

RDV

CPN

Help Format

360 days

Compounding Frequency

Semi-annual

Bond Interval

Term

360 Semi Term

Edit Calculations

Bond Calculation

d1 / /

d2 / /

N 5

RDV 100

CPN 3

PRC -97.64327025

YLD 4

INT 0

Cost -97.64327025

Help Format

Solve 360 Semi Term

Calculation Formulas

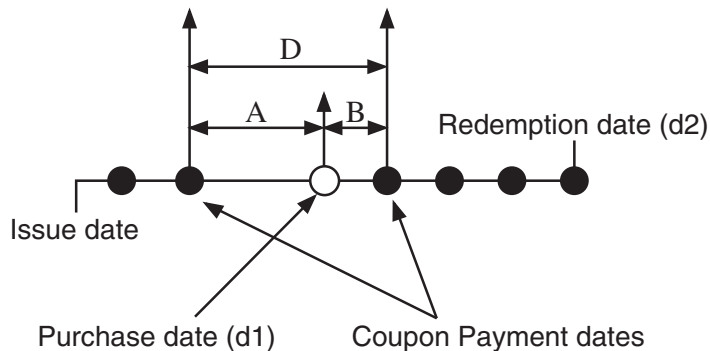

- PRC* : price per \$100 of face value
CPN : coupon rate (%)
YLD : annual yield (%)
A : accrued days
M : number of coupon payments per year (1 = Annual, 2 = Semi-annual)
N : number of coupon payments until maturity
 (*n* is used when "Term" is specified for [Bond Interval] in the [Format] tab.)
RDV : redemption price per \$100 of face value
D : number of days in coupon period where settlement occurs
B : number of days from purchase date until next coupon payment date = $D - A$
INT : accrued interest
CST : price including interest

• Price per \$100 of face value (PRC)

Bond Interval Setting: Date

- For one or fewer coupon period to redemption

$$PRC = - \frac{RDV + \frac{CPN}{M}}{1 + \left(\frac{B}{D} \times \frac{YLD/100}{M} \right)} + \left(\frac{A}{D} \times \frac{CPN}{M} \right)$$

- For more than one coupon period to redemption

$$PRC = - \frac{RDV}{\left(1 + \frac{YLD/100}{M}\right)^{(N-1+B/D)}} - \sum_{k=1}^N \frac{\frac{CPN}{M}}{\left(1 + \frac{YLD/100}{M}\right)^{(k-1+B/D)}} + \frac{A}{D} \times \frac{CPN}{M}$$

$$INT = - \frac{A}{D} \times \frac{CPN}{M}$$

$$CST = PRC + INT$$



Bond Interval Setting: Term

$$PRC = - \frac{RDV}{\left(1 + \frac{YLD/100}{M}\right)^n} - \sum_{k=1}^n \frac{\frac{CPN}{M}}{\left(1 + \frac{YLD/100}{M}\right)^k}$$

$$INT = 0$$

$$CST = PRC$$

• **Annual Yield (YLD)**

YLD is calculated using Newton's Method.

Note

- The Financial application performs annual yield (YLD) calculations using Newton's Method, which produces approximate values whose precision can be affected by various calculation conditions. Because of this, annual yield calculation results produced by this application should be used keeping the above in mind, or results should be confirmed separately.



15-11 Break-Even Point

Break-Even Point lets you calculate the amount you must sell to break even or to obtain a specified profit, as well as the profit or loss on particular sales.

Break-Even Point Fields

The following fields appear on the Break-Even Point calculation page.

Field	Description
PRC	Selling price per unit
VCU	Variable cost per unit
FC	Fixed costs
PRF	Amount of profit realized
QBE	Number of units to be sold
SBE	Amount that must be obtained from sales to break even
r%	Proportion of sales amount retained as a profit (as a percent)

Financial Application Default Setup for Examples

You can use the [Format] tab to change the following settings. You can also change these settings by tapping the status bar.

Profit Amount/Ratio: Amount (PRF)

Break-Even Value: Quantity

Scenario

Your company is producing items with a unit variable cost ([VCU]) of \$50/unit and fixed costs ([FC]) of \$100,000. The items will be sold for a sales price ([PRC]) of \$100/unit.



■ **Example 1**

What is the break-even point sales amount ([SBE]) and sales quantity ([QBE]) required for a profit ([PRF]) of \$400,000?

The screenshot shows a calculator interface with a window titled "Edit Calculations". Inside the window, there is a section titled "Break-Even Point" with the following fields and values:

PRC	100
VCU	50
FC	100000
PRF	400000
QBE	10000
SBE	1000000
r%	

At the bottom of the window, there are buttons for "Help" and "Format". Below the window, the status bar shows "Solve PRF Qty" and a calculator icon.

Note

- You need to calculate the break-even point sales quantity ([QBE]) before you will be able to calculate the break-even sales amount ([SBE]).



■ Example 2

What is the break-even point sales amount ([SBE]) and sales quantity ([QBE]) to attain a profit ratio ([r%]) of 40%?

- For this example, use the [Format] tab to change the [Profit Amount/Ratio] setting to “Ratio (r%)” or tap “PRF” in the status bar to change it to “r%”.

The screenshot shows a dialog box titled "Edit Calculations" with a "Break-Even Point" section. It contains several input fields with their corresponding values:

PRC	100
VCU	50
FC	100000
PRF	400000
QBE	10000
SBE	1000000
r%	40

At the bottom of the dialog, there are buttons for "Help" and "Format". Below the dialog, the status bar shows "Solve r% Qty" and a calculator icon.

Calculation Formulas

- Profit (Profit Amount/Ratio Setting: Amount (PRF))

$$QBE = \frac{FC + PRF}{PRC - VCU}$$

$$SBE = \frac{FC + PRF}{PRC - VCU} \times PRC$$

- Profit Ratio (Profit Amount/Ratio Setting: Ratio (r%))

$$QBE = \frac{FC}{PRC \times \left(1 - \frac{r\%}{100}\right) - VCU}$$

$$SBE = \frac{FC}{PRC \times \left(1 - \frac{r\%}{100}\right) - VCU} \times PRC$$

15-12 Margin of Safety

Margin of Safety lets you calculate how much sales can be reduced before losses are incurred.

Margin of Safety Fields

The following fields appear on the Margin of Safety calculation page.

Field	Description
SAL	Amount obtained from sales
SBE	Break-even sales (amount that must be obtained from sales to break even)
MOS	Margin of safety (portion of sales amount above break-even point)

■ Example

What is the margin of safety ([MOS]) when the sales amount ([SAL]) is \$1,200,000 and the break-even sales amount ([SBE]) is \$1,000,000?

- You can calculate the break-even sales amount ([SBE]) using Break-Even Point (page 15-11-1).

The screenshot shows a software interface for calculating the Margin of Safety. The window is titled "Edit Calculations". It features a toolbar with icons for navigation (back, forward), editing (undo, redo, delete), and calculation (solve, help). The main content area is titled "Margin of Safety" and contains three input fields: "SAL" with the value "1200000", "SBE" with the value "1000000", and "MOS" with the value "0.1666666667". At the bottom of the window, there are buttons for "Help" and "Format", and a "Solve" button with a calculator icon.

- You can also calculate the sales amount ([SAL]) or break-even sales amount ([SBE]) by inputting the other two values and tapping the button for the result you want.

Calculation Formulas

$$MOS = \frac{SAL - SBE}{SAL}$$

15-13 Operating Leverage

Operating leverage lets you calculate the degree of change in net earnings arising from a change in sales amount.

Operating Leverage Fields

The following fields appear on the Operating Leverage calculation page.

Field	Description
SAL	Amount currently obtained from sales
VC	Variable cost for this level of production
FC	Fixed costs
DOL	Degree of operating leverage

■ Example

What is the degree of operating leverage for a company with sales ([SAL]) of \$1,200,000, variable costs ([VC]) of \$600,000, and fixed costs ([FC]) of \$200,000?

The screenshot shows a calculator interface titled "Edit Calculations". Inside the window, there is a section titled "Operating Leverage" with four input fields: SAL (1200000), VC (600000), FC (200000), and DOL (1.5). At the bottom of the window, there are buttons for "Help", "Format", and "Solve".

- You can also calculate sales amount ([SAL]), variable costs ([VC]), or fixed costs ([FC]) by inputting the other three values and tapping the button for the result you want.

Calculation Formulas

$$DOL = \frac{SAL - VC}{SAL - VC - FC}$$

15-14 Financial Leverage

Financial Leverage lets you calculate the degree of change in net earnings arising from a change in interest paid.

Financial Leverage Fields

The following fields appear on the Financial Leverage calculation page.

Field	Description
EBIT	Earnings before interest and taxes
INT	Interest to be paid to bondholders
DFL	Degree of financial leverage

■ Example

Calculate the financial leverage ([DFL]) for a company that earns \$400,000 before interest and taxes ([EBIT]), \$80,000 of which is paid to bondholders ([INT]).

The screenshot shows a calculator window titled "Edit Calculations" with a toolbar containing icons for back, forward, delete, copy, paste, and grid. The main area is titled "Financial Leverage" and contains three input fields: EBIT (400000), INT (80000), and DFL (1.25). At the bottom, there are buttons for "Help" and "Format", and a "Solve" button with a grid icon.

- You can also calculate earnings before interest and taxes ([EBIT]) or interest to be paid to bondholders ([INT]) by inputting the other two values and tapping the button for the result you want.

Calculation Formulas

$$DFL = \frac{EBIT}{EBIT - ITR}$$

15-15 Combined Leverage

Combined Leverage lets you calculate the combined effects of operation and financial leverages.

Combined Leverage Fields

The following fields appear on the Combined Leverage calculation page.

Field	Description
SAL	Amount obtained from sales
VC	Variable cost for this level of production
FC	Fixed costs
INT	Interest to be paid to bondholders
DCL	Degree of combined leverage

■ Example

Calculate the Combined Leverage ([DCL]) for a company with variable costs ([VC]) of \$6,000, fixed costs ([FC]) of \$2,000, and sales ([SAL]) of \$12,000, of which \$1,000 is paid to bondholders ([INT]).

The screenshot shows a calculator interface titled 'Edit Calculations'. It has a toolbar with navigation and editing icons. The main area is titled 'Combined Leverage' and contains five input fields with labels and values:

- SAL: 12000
- VC: 6000
- FC: 2000
- INT: 1000
- DCL: 2

At the bottom, there are buttons for 'Help' and 'Format', and a 'Solve' button with a calculator icon.

- You can also calculate variable costs ([VC]), fixed costs ([FC]), sales ([SAL]), or the amount or paid to bondholders ([INT]) by inputting the other four values and tapping the button for the result you want.

Calculation Formulas

$$DCL = \frac{SAL - VC}{SAL - VC - FC - ITR}$$

15-16 Quantity Conversion

Quantity Conversion lets you calculate the number of items sold, selling price, or sales amount given the other two values. It also lets you calculate the number of items manufactured, unit variable cost, or total variable cost given the other two values.

Quantity Conversion Fields

The following fields appear on the Quantity Conversion calculation page.

Field	Description
SAL	Amount obtained from sales
PRC	Selling price per unit
QTY	Number of units sold
VC	Variable cost for this level of production
VCU	Variable cost per unit
QTY	Number of units manufactured

■ Example 1

Calculate the sales quantity (Sales: [QTY]) when the sales amount ([SAL]) is \$100,000 and the sales price ([PRC]) is \$200 per unit.

Quantity Conversion

Sales

<input type="text" value="SAL"/>	<input type="text" value="100000"/>
<input type="text" value="PRC"/>	<input type="text" value="200"/>
<input type="text" value="QTY"/>	<input type="text" value="500"/>

- You can also calculate the sales amount ([SAL]) or sales price ([PRC]) by inputting the other two values and tapping the button for the result you want.



■ Example 2

Calculate the total variable costs of production (Manufacturing: [VC]) when the variable cost per unit ([VCU]) is \$30 and the number of units manufactured ([QTY]) is 500.

Manufacturing	
VC	15000
VCU	30
QTY	500

- You can also calculate the variable cost per unit ([VCU]) or number of units manufactured ([QTY]) by inputting the other two values and tapping the button for the result you want.

Calculation Formulas

$$SAL = PRC \times QTY$$

$$VC = VCU \times QTY$$



Chapter 16

Configuring System Settings

The ClassPad unit's System application lets you configure global system settings and access system information.

- 16-1 System Setting Overview**
- 16-2 Managing Memory Usage**
- 16-3 Using the Reset Dialog Box**
- 16-4 Initializing Your ClassPad**
- 16-5 Adjusting Display Contrast**
- 16-6 Configuring Power Properties**
- 16-7 Specifying the Display Language**
- 16-8 Specifying the Font Set**
- 16-9 Specifying the Alphabetic Keyboard Arrangement**
- 16-10 Optimizing "Flash ROM"**
- 16-11 Specifying the Ending Screen Image**
- 16-12 Adjusting Touch Panel Alignment**
- 16-13 Viewing Version Information**
- 16-14 Registering a User Name on a ClassPad**
- 16-15 Specifying the Complex Number Imaginary Unit**
- 16-16 Assigning Shift Mode Key Operations to Hard Keys**

16-1 System Setting Overview

This section describes the configuration of the System application window, and provides information about its menus and commands.

Starting Up the System Application

Use the following procedure to start up the System application.

- **ClassPad Operation**

On the application menu, tap .

This starts the System application and displays the Memory Usage window.





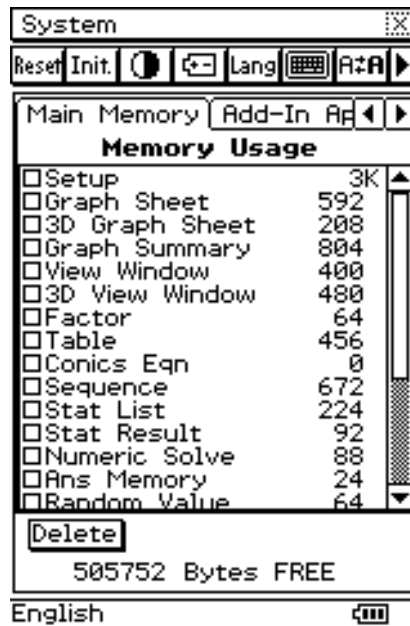





System Application Window

The [Main Memory] sheet appears first on the Memory Usage window whenever you start up the System application. You can use this sheet to find out how much memory is being used for specific tasks. Other sheets contain information about memory being used by add-in applications, eActivity, and built-in languages.



System Application Menus and Buttons

To perform an operation in the System application, select it on the [System] menu or tap the applicable toolbar button.

To do this:	Tap this button:	Or select this System menu item:
Reset the ClassPad unit (which deletes all variable and program data in main memory and all eActivity data in the storage area)		Reset
Initialize the ClassPad unit (which returns all flash ROM data to its factory default state)		Initialize
Adjust display contrast		Contrast
Configure power saving and auto power off settings		Power Properties
Change the display text language		Language
Specify the complex number imaginary unit	—	Imaginary Unit
Change the font set		Font Select
Change the arrangement of the alphabet (abc) soft keyboard		Keyboard
Optimize Flash ROM		Memory Management
Select the image data for the ending screen that appears when the ClassPad unit is turned off		Ending Screen
Adjust the alignment of the touch panel		Touch Panel Alignment
Display software version information		Version(Software)
Display hardware version information	—	Version(Hardware)
Assign shift mode key operations to hard keys	—	Shift Keys
Register a user name on a ClassPad	—	ClassPad Name

- Details about each of the above settings can be found in the following sections of this chapter.



16-2 Managing Memory Usage

You can use [Memory Usage] to determine how much data is stored in the main memory and the storage area, and to delete data.

[Memory Usage] appears first whenever you tap  on the application menu to start up the System application.

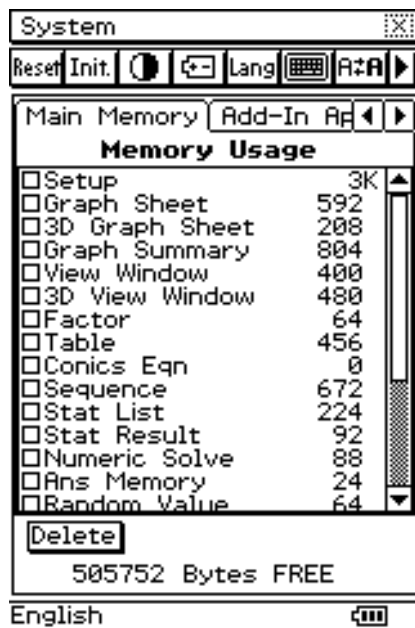

See “Memory Usage Sheets” below for details about [Memory Usage] contents. Displayed values are all approximate.

[Memory Usage] contains the following four sheets.

To view this:	Select this tab:
Memory usage of variable data and program data stored in main memory	Main Memory
Names and memory usage of add-in applications stored in the storage area	Add-In App.
Names and memory usage of eActivity data stored in the storage area	eActivity
Names and memory usage of language data stored in the storage area	Language

Memory Usage Sheets

The following sections explain the meaning of each of the sheets in [Memory Usage].

Main Memory Tab

This item:	Shows how much memory is used by this type of data:
Setup	All setup data and other setup information (page 1-9-1)
Graph Sheet	2-dimensional function data (including sheet name data and function selection data)
3D Graph Sheet	3-dimensional function data (including sheet name data and function selection data)



16-2-2
Managing Memory Usage

This item:	Shows how much memory is used by this type of data:
Graph Summary	Summary table data
View Window	2-dimensional View Window parameter values
3D View Window	3-dimensional View Window parameter values
Factor	Zoom factor values
Table	Range values and table result values
Conics Eqn	Conics expressions
Sequence	Sequential and recursion data (including function selection and other information), and sequence data (including initial value and range information)
Stat List	list1 through list6
Stat Result	Statistical calculation results
Numeric Solve	Solve expression and solve range
Ans Memory	Main application Ans data
Random Value	Random command setting data
Main History	Main application history data
User Defined	User-defined variables and user-created folders
Library	“library” folder data
eActivity	eActivity application temporary data*
Geometry	Geometry application temporary data*
Spreadsheet	Spreadsheet application temporary data*
System	Other system data
Clipboard	Clipboard data

* “temporary data” is data that is created by an application but not saved in memory.



Add-In App. Tab

This sheet lists all of the add-in applications currently installed on your ClassPad, and shows the size of each application.

eActivity Tab

This sheet lists the names of all the files that have been created with the eActivity application, and shows the size of each file.

Language Tab

This sheet lists language data used for the ClassPad menus and messages.

This item:	Shows the data for this language:
Deutsch	German
English	English
Español	Spanish
Français	French
Português	Portuguese

Deleting Memory Usage Data

You can use the following procedure to delete memory usage data.

• ClassPad Operation

- (1) Tap the memory usage tab (Main Memory, Add-In App., eActivity, or Language) that contains the data you want to delete.
- (2) Select the check box next to the item whose data you want to delete.
- (3) Tap the [Delete] button.
- (4) On the confirmation dialog box that appears, tap [OK] to delete the selected data, or [Cancel] to cancel the delete operation.
 - Tapping [OK] displays the message “Now deleting...” while the data is being deleted.
 - The above procedure deletes all of the data you selected, and updates memory usage values accordingly.

Tip

- You cannot delete any data that has “dim” in its check box.
- For information about deleting all variable data and program data, and deleting all eActivity data, see “16-3 Using the Reset Dialog Box”.



16-3 Using the Reset Dialog Box

You can perform the following operations from the Reset dialog box.

- Delete all variable and program data in main memory
- Delete all eActivity data in storage memory

• ClassPad Operation

(1) On the application menu, tap  .

- This starts up the System application.

(2) Tap to display the Reset dialog box.

- To cancel the reset operation at any time before you execute it in step (5) of this procedure, tap [Cancel].

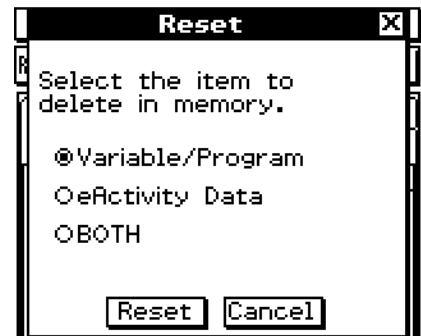

(3) On the Reset dialog box, select the type of reset operation you want to perform.

To delete this type of data:	Select this option:
All variable and program data in main memory	Variable/Program
All eActivity data in the storage area	eActivity Data
All variable and program data in main memory and all eActivity data in the storage area	BOTH

- (4) After selecting the type of reset operation you want to perform, tap [Reset].
- (5) In response to the confirmation message that appears, tap [OK] to perform the reset operation, or [Cancel] to cancel.
- (6) Follow the instructions that appear on the display.



16-4 Initializing Your ClassPad

The initialization procedure provides you with a choice of two options. You can either clear the Flash ROM entire and return its data to the factory default state, or you can specify deletion of all user formulas and data, without deleting any currently installed add-in applications.

Warning!

Initializing the ClassPad deletes anything you have input and stored in memory (including eActivity data) since you purchased the ClassPad or last initialized it.

Before initializing the ClassPad, double-check to make sure you do not need any of the data that will be deleted.

• **ClassPad Operation**

(1) On the application menu, tap .

- This starts up the System application.

(2) Tap .

- This displays a dialog box asking if you want to retain or delete add-in applications.

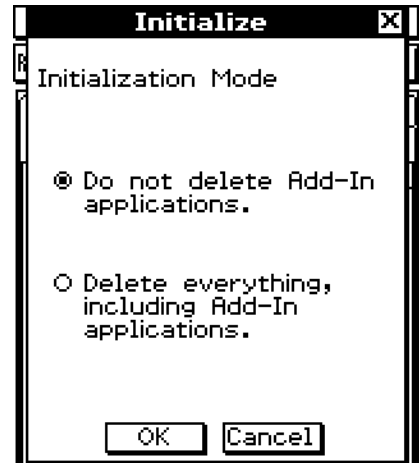

(3) Tap the button next to the initialization mode you want to select, and then tap [OK].

- This displays a confirmation asking if you really want to initialize your ClassPad.

(4) On the message dialog box, press .

- This causes the ClassPad to restart.

(5) Perform the touch panel alignment, contrast adjustment, display language selection, and keyboard configuration operations as their dialog boxes appear on the ClassPad display.



- The application menu appears after you finish all of the settings in step (5).
- For more information about the procedures you need to perform in step (5), see “Replacing Batteries and Setting Up the ClassPad” at the beginning of this user’s guide (page 3).



16-5 Adjusting Display Contrast



Use the following procedure to display the Contrast dialog box and adjust display contrast.

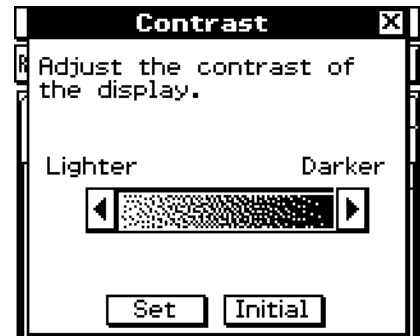

• ClassPad Operation

- (1) On the application menu, tap .
 - This starts up the System application.
- (2) Tap  to display the Contrast dialog box.



- (3) Adjust display contrast.

To do this:	Tap this button:
Make the display lighter	
Make the display darker	
Return contrast to its initial factory default setting	Initial

- Tapping and holding  or  continually performs the applicable operation until you release the button.

- (4) To close the Contrast dialog box, tap [Set].



16-6 Configuring Power Properties

Use the Power Properties dialog box to configure the power saving mode and auto power off (APO) settings.

Power Saving Mode

Your ClassPad has a “resume” feature that remembers its status when you turn it off, and restores the same status the next time you turn the ClassPad back on. Resume feature operation requires power to operate, which means that some power continues to be consumed even while the ClassPad is turned off. The power saving mode lets you limit how long the resume feature continues to operate (and consume power) after you turn off the ClassPad unit. You can specify 1 hour, 6 hours, or 1 day. After the time limit you specify is reached, the resume feature is deactivated.

The following table describes the power saving mode options that are available.

To do this:	Select this power saving mode option:
Turn off the power saving mode (unlimited resume time)	Off
Limit resume operation to 1 hour after power down	1 hour
Limit resume operation to 6 hours after power down	6 hours
Limit resume operation to 1 day after power down	1 day

- The initial default for the above setting is [1 day].

Auto Power Off

The Auto Power Off (APO) feature helps conserve battery power by turning off the ClassPad unit automatically whenever you do not perform any operation for specified amount of time. You can specify 1, 3, 6, or 60 minutes for the Auto Power Off trigger time. The initial default APO setting is 6 minutes.



Configuring Power Properties

• ClassPad Operation

(1) On the application menu, tap .

- This starts up the System application.

(2) Tap  to display the Power Properties dialog box.

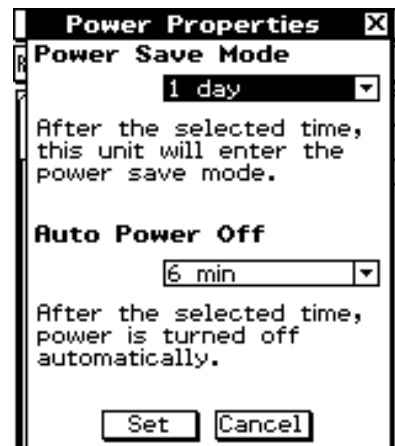

(3) Configure the Power Save Mode and Auto Power Off settings.

- See “Power Saving Mode” and “Auto Power Off” on page 16-6-1 for details about these settings.

(4) After all the settings are the way you want, tap [Set] to apply them and close the Power Properties dialog box, or tap [Cancel] to close without changing any settings.

- Tapping [Set] or [Cancel] returns you to [Memory Usage].



16-7 Specifying the Display Language

You can use the following procedure to specify German, English, Spanish, French, or Portuguese as the display language.

• ClassPad Operation

- (1) On the application menu, tap  .
 - This starts up the System application.
- (2) Tap **Lang** to display the Language dialog box.

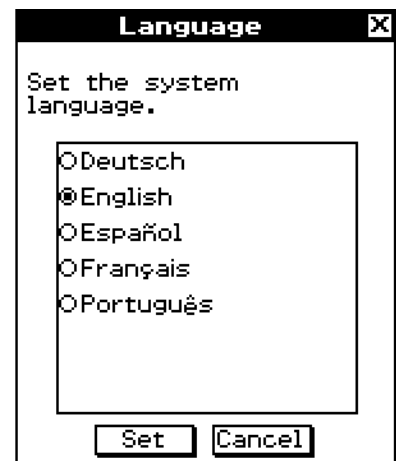

- (3) In the list of languages, tap the one you want to use as the display language.
- (4) After the setting is the way you want, tap [Set] to apply it and close the Language dialog box, or tap [Cancel] to close without changing the setting.
 - Tapping [Set] returns you to the application menu.
 - Tapping [Cancel] returns you to [Memory Usage].





16-8 Specifying the Font Set

You can select either “Regular” or “Bolder” as the display font type.

	Regular	Bolder
Text Input		
Menu		

• ClassPad Operation

- (1) On the application menu, tap .
 - This starts up the System application.
- (2) Tap  to display the Font Select dialog box.

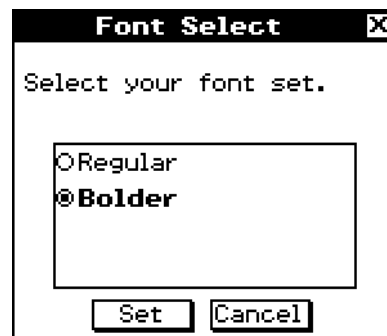

- (3) In the list of font sets, tap the one you want to use.
- (4) After the setting is the way you want, tap [Set] to apply it and close the Font Select dialog box, or tap [Cancel] to close without changing the setting.
 - Tapping [Set] returns you to the application menu.
 - Tapping [Cancel] returns you to [Memory Usage].

16-9 Specifying the Alphabetic Keyboard Arrangement

The Keyboard dialog box lets you select from among three different key arrangements for the alphabetic (abc) soft keyboard: QWERTY, AZERTY, or QWERTZ. The initial default setting is QWERTY.



QWERTY





AZERTY



QWERTZ

• ClassPad Operation

- (1) On the application menu, tap .
 - This starts up the System application.
- (2) Tap  to display the Keyboard dialog box.



- (3) In the list of keyboard arrangements, tap the one you want to use for the alphabetic (abc) soft keyboard.
- (4) After the setting is the way you want, tap [Set] to apply it and close the Keyboard dialog box, or tap [Cancel] to close without changing the setting.
 - Tapping [Set] returns you to the application menu.
 - Tapping [Cancel] returns you to [Memory Usage].

16-10 Optimizing “Flash ROM”

Use the following procedure to perform a “garbage collection” operation that optimizes Flash ROM. Optimizing Flash ROM increases the amount of memory available for storage.

• ClassPad Operation

(1) On the application menu, tap .

- This starts up the System application.

(2) Tap .

- This displays a confirmation asking if you really want to optimize Flash ROM.

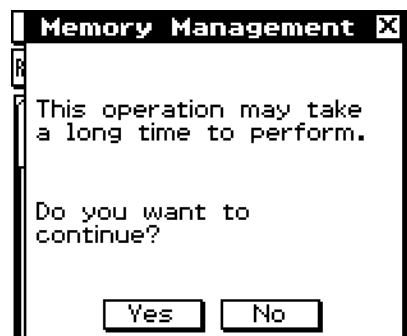

(3) Tap [Yes] to optimize Flash ROM, or [No] to cancel.

- After you tap [Yes], the message “Now Optimizing...” remains displayed while optimization is in progress. The message “Complete!” appears when optimization is complete.

(4) Tap [OK] to close the “Complete!” message dialog box.

- This returns you to [Memory Usage].

Tip

- You can interrupt the “garbage collection” operation by tapping **ESC** on the icon panel. Tap [OK] on the dialog box that appears to return to [Memory Usage].

Important!

- Never press the P button on the back of the ClassPad while a “garbage collection” operation is in progress. Doing so can damage memory, resulting in loss of all memory contents and malfunction of your ClassPad. If this happens, you will need to request repair from your CASIO Maintenance Service Provider. Note that repair of your ClassPad will not recover any lost memory contents.



16-11 Specifying the Ending Screen Image

Whenever you press the **ON/OFF** key to turn off the ClassPad unit, it copies any data currently in RAM to Flash ROM, and then turns off power. The ending screen is what appears on the display while the RAM data save operation is being performed, until power is actually turned off. You can specify the image data you want to appear as the ending screen.

• ClassPad Operation

(1) On the application menu, tap .

- This starts up the System application.

(2) Tap **END** to display the Ending Screen dialog box.

- To see this icon, you must first tap the right arrow button on the toolbar to scroll.

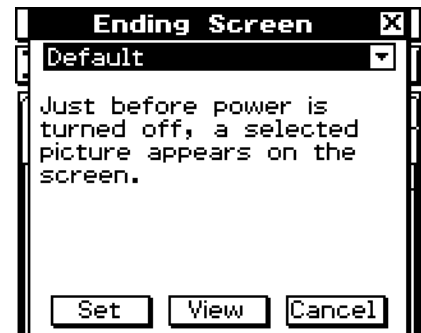

(3) Tap the down arrow button. On the list that appears, tap the ending screen image you want to use.

- To see the list, open the drop down list near the top of the dialog box. The list shows the images in the file you created with the Presentation application.
- Tapping the [View] button displays a preview of the currently selected screen image. Tap [OK] to close the preview image and others (see Tip below).

(4) After the image you want is selected, tap [Set] to apply it and close the Ending Screen dialog box, or tap [Cancel] to close the dialog box without changing the setting.

- Tapping [Set] or [Cancel] returns you to [Memory Usage].

Tip

- A bitmap you create and save with the Picture application can be used as an ending screen image. The allowable bitmap size for an ending screen image is 160 × 240 pixels.
- A bitmap of a Graph window can also be created in the Graph & Table and 3D Graph applications. Draw a graph and then select [Store Picture] from the  menu.



16-12 Adjusting Touch Panel Alignment

You should adjust touch panel alignment whenever you find that the wrong operation or no operation is performed when you tap the ClassPad screen.

• ClassPad Operation

(1) On the application menu, tap  .

- This starts up the System application.

(2) Tap  to display the touch panel alignment screen.

- To see this icon, you must first tap the right arrow button on the toolbar to scroll.

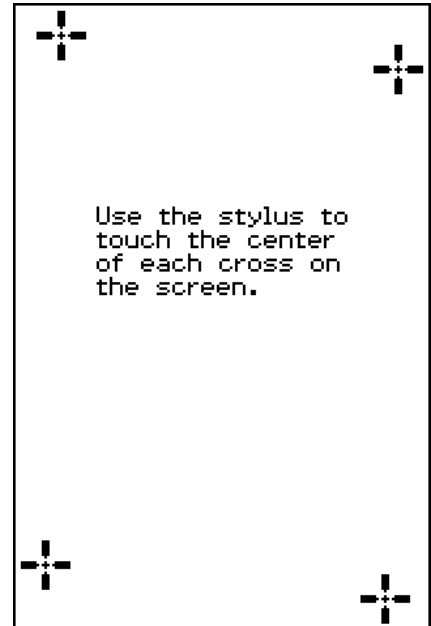

(3) Use the stylus to tap the center of each of the four crosses as they appear on the screen.

- Tapping the center of the fourth cross completes touch panel alignment and returns you to [Memory Usage].
- When aligning your ClassPad try to tap the exact center of each cross.



16-13 Viewing Version Information

Use the following procedure when you want to view version information about your ClassPad's operating system.

• To view software version information

- (1) On the application menu, tap  .
 - This starts up the System application.
- (2) Tap to display the Version dialog box.



- (3) To close the Version dialog box, tap [OK]. This returns you to [Memory Usage].

• To view hardware version information

During step (2) the procedure under "To view software version information" above, tap [System] and then [Version(Hardware)].

This displays the Version dialog box, which shows the ClassPad processor name and other hardware information.



To close the Version dialog box, tap [OK].



16-14 Registering a User Name on a ClassPad

You can register your name on your ClassPad so it appears at the bottom of the application menu screen.

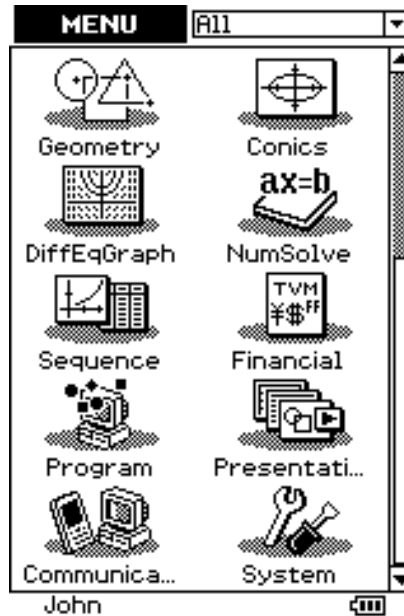

• ClassPad Operation

- (1) On the application menu, tap .
 - This starts up the System application.
- (2) Tap [System] and then [ClassPad Name] to display the ClassPad Name dialog box.
- (3) Enter your name on the dialog box.
- (4) Tap [Set] to register your name or [Cancel] to cancel.



16-15 Specifying the Complex Number Imaginary Unit

In mathematics, the imaginary unit i allows the real number system \mathbb{R} to be extended to the complex number system \mathbb{C} .

In electrical engineering and related fields, the imaginary unit is often written as j to avoid confusion with a changing current, traditionally denoted by i .

Your ClassPad lets you specify either “ i ” or “ j ” for the imaginary unit.

```
solve(x^2+1,x)
{x=-j,x=j}
```

• ClassPad Operation

- (1) On the application menu, tap .
 - This starts up the System application.
- (2) Tap [System] and then [Imaginary Unit] to display the Imaginary Unit dialog box.
- (3) On the Imaginary Unit dialog box, select the type of imaginary unit you want to use.

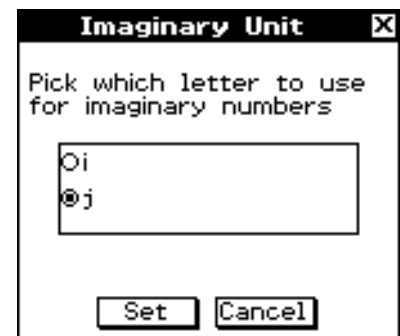

- (4) After the setting is the way you want, tap [Set] to apply it and close the Imaginary Unit dialog box, or tap [Cancel] to close without changing the setting.



16-16 Assigning Shift Mode Key Operations to Hard Keys

You can configure your ClassPad so the \ominus key functions as a shift key, and assign shift mode key operations (such as character strings or function names, or operations) to the hard keys. Then you can access a hard key shift mode operation by pressing the \ominus key and then the hard key.



• ClassPad Operation

(1) On the application menu, tap .

- This starts up the System application.

(2) Tap [System] and then [Shift Keys] to display the Shift Key Assign dialog box.

(3) On the Shift Key Assign dialog box, select the “Set (–) as shift key” check box.

(4) Tap the down arrow button then select the hard key to which you want to assign a shift mode character string.



(5) Input the character string or function name, or specify the operation you want to assign to the hard key.

- Use the soft keyboard to assign a character string or function name.







- To assign the Cut, Copy, Paste, or Undo/Redo operation, tap the applicable button on the dialog box.



- To clear the current assignment from the hard key, tap [Clear Assignment].
- (6) After all the settings are the way you want, tap [OK] to apply them and close the Shift Key Assign dialog box.





Example : To configure a shift operation that inserts the variable assignment character “v” automatically when \ominus and $\omin�$ key are pressed.

• ClassPad Operation

- (1) Perform steps (1) through (3) of the above operation to enable shift key assignment.
 - (2) Tap the down arrow button and select [=].
 - (3)   
 - (4) Tap inside the box next to the [Set] button. Tap  in the soft keyboard.
 - (5) Tap the [OK] button.
- Now When you press $\omin�$ and then \ominus , the “v” will appear.

• Using the Shift Mode with a Cursor Key

When the shift function of the $\omin�$ key is enabled, you can use it with cursor key.

- Shift : Moves the cursor to the beginning of the current line
- Shift : Moves the cursor to the end of the current line
- Shift  or : Select the expression in the current line to the right or left of the cursor



Chapter 17

Performing Data Communication

You can use the SB-62 data communication cable to connect your ClassPad to another ClassPad unit or to a CASIO Data Analyzer, and transfer data between them.

To transfer data between a ClassPad and a personal computer, you need to use the special USB cable that comes with ClassPad.

This chapter explains how to perform data communication operations and exchange data.

- 17-1 Data Communication Overview**
- 17-2 Connecting the ClassPad to Another Device**
- 17-3 Configuring Communication Parameters**
- 17-4 Transferring Data to Another ClassPad Unit**

17-1 Data Communication Overview

This section provides an overview of the types of connections that are possible, and the data that can be transferred over each connection. It also tells you how to use the Communication application to transfer data.

Important!

- Never press the P button on the back of the ClassPad while a data communication operation is in progress. Doing so can damage memory, resulting in loss of all memory contents and malfunction of your ClassPad. If this happens, you will need to request repair from your CASIO Maintenance Service Provider. Note that repair of your ClassPad will not recover any lost memory contents.

Connectable Devices and Transferable Data

The following three types of connections are possible.

- Two ClassPad units
- A ClassPad and a computer
- A ClassPad and a CASIO EA-200 Data Analyzer

The following provides details about each of these connections, and describes the type of data that can be transferred over each.

■ Connecting Two ClassPad Units

You can transfer variable data, eActivity data, and display image data between two ClassPad units.

- For information about variables, see “1-7 Variables and Folders”.
- For information about eActivity data, see “Chapter 10 – Using the eActivity Application”.
- For information about display image data, see “Sending a Screenshot of the Current Display Contents” on page 17-4-5.

● Connection

Use the special SB-62 3-pin data communication cable to connect two ClassPad units. For details, see “Connecting to Another ClassPad Unit” on page 17-2-1.

● How to Transfer Data

You can use either of the two following methods to transfer data between two ClassPad units.

- Use the Communication application. See “17-4 Transferring Data to Another ClassPad Unit” for details.
- Use the “SendVar38k” and “GetVar38k” program commands. See “Chapter 12 – Using the Program Application” for details.



■ Connecting a ClassPad to a Computer

You can perform the following operations when connected to a computer.

- Transfer variable data and eActivity data between the ClassPad and a computer
- Install add-in applications, language data, and operating system upgrades onto your ClassPad from the computer
- Transfer ClassPad display image data to the computer
- For information about variables, see “1-7 Variables and Folders”.
- For information about eActivity data, see “Chapter 10 – Using the eActivity Application”.
- For information about display image data, see “Sending a Screenshot of the Current Display Contents” on page 17-4-5.
- See the FA-CP1 User’s Guide for details about add-in application installation and uninstallation, language data installation, and upgrading your operating system.
- Your ClassPad may operate abnormally after you update its operating system from your computer using FA-CP1 if the operating system you install is not compatible with your ClassPad hardware version. If you accidentally install an operation system version that is not compatible with your ClassPad hardware version, visit the following Website information about what you need to do to get your ClassPad working normally again.

<http://edu.casio.com/products/classpad/>

● Connection

Use the special USB cable to connect the ClassPad’s 4-pin mini USB port to your computer’s USB port. For details, see “Connecting to a Computer (USB)” on page 17-2-3.

● How to Transfer Data

On the ClassPad, use the Communication application. On your computer, use FA-CP1. For details, see the FA-CP1 User’s Guide.

■ Connecting a ClassPad to a CASIO EA-200 Data Analyzer

You can perform the following operations when connected to a Data Analyzer.

- Transfer Data Analyzer setup information and sampled data to the ClassPad
- Transfer variable data, eActivity data, and Data Analyzer setting information from the ClassPad to the Data Analyzer
- For information about variables, see “1-7 Variables and Folders”.
- For information about eActivity data, see “Chapter 10 – Using the eActivity Application”.
- For information about Data Analyzer setup information and sample data, see the user documentation that comes with the Data Analyzer.

● Connection

Use the special SB-62 3-pin data communication cable to connect two units. For details, see “Connecting to an EA-200 Data Analyzer” on page 17-2-2.



• How to Transfer Data

Use the “Send38k” and “Receive38k” program commands to transfer data. For details, see “Chapter 12 – Using the Program Application”, and the user documentation that comes with the Data Analyzer.

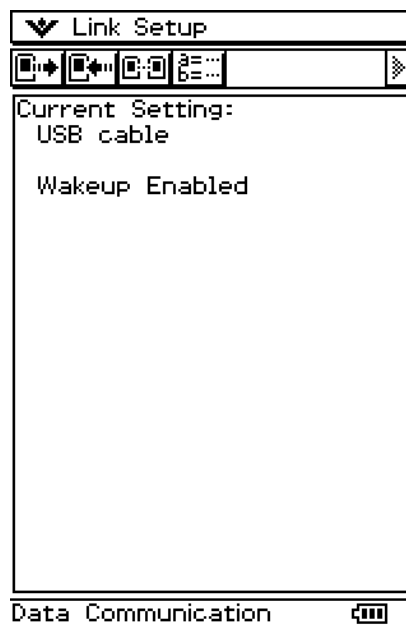

Using the ClassPad Communication Application

To perform a data transfer operation, tap  on the application menu to start up the Communication application.



■ Communication Application Menus and Buttons

The following explains the operations you can perform using the menus and buttons of the Communication application.

To do this:	Tap this button:	Or select this menu item:
Select data to send		Link - Transmit
Enter receive standby		Link - Receive
Enter standby for add-in application or language data install	–	Link - Install - Add-In
Enter standby for operating system upgrading	–	Link - Install - OS Update
Enter standby to receive a display image from another ClassPad unit		Link - Screen Receive
Configure communication parameters	–	Setup - Open Setup Menu
Display hardware version information	–	Setup - Version(Hardware)

- For details about configuring communication parameters, see “17-3 Configuring Communication Parameters”.



17-2 Connecting the ClassPad to Another Device

This section provides detailed explanations about how to connect the ClassPad to another ClassPad unit, to a computer, and to a CASIO Data Analyzer.

Connecting to Another ClassPad Unit

Use the procedure below to connect two ClassPad units.

■ Required Hardware

ClassPad: 2 units

Special SB-62 Cable: 1

● ClassPad Operation

- (1) Turn both units off.
- (2) Connect the data communication cable as shown in the illustration below.
 - Insert both of the plugs securely, as far as they will go.

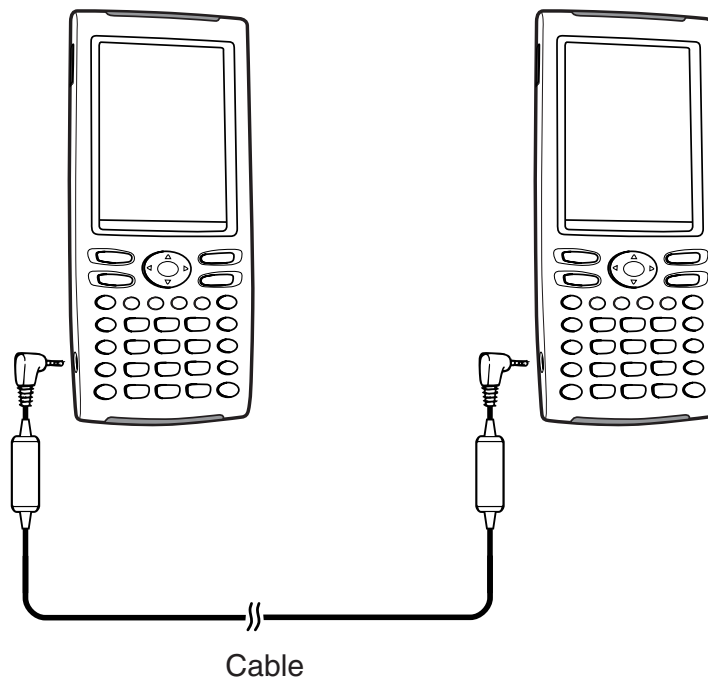

- For information about what you should do to transfer data, see “17-4 Transferring Data to Another ClassPad Unit”.



Connecting to an EA-200 Data Analyzer

You can use the CASIO Data Analyzer to sample and collect data on various everyday natural phenomena. You can also connect the Data Analyzer to your ClassPad, and control Data Analyzer operation from your ClassPad. You can transfer setup information from the ClassPad to the Data Analyzer, trigger sampling from the ClassPad, and graph sample results on your ClassPad.

■ Required Hardware

ClassPad: 1 unit

EA-200 Data Analyzer: 1

Special SB-62 Cable: 1

● ClassPad Operation

- (1) Turn off the ClassPad and Data Analyzer.
- (2) Remove the connector cover from the 3-pin communication port of the Data Analyzer, and connect one end of the data communication cable to the port.
- (3) Connect the other end of the data communication cable to the 3-pin communication port of the ClassPad.

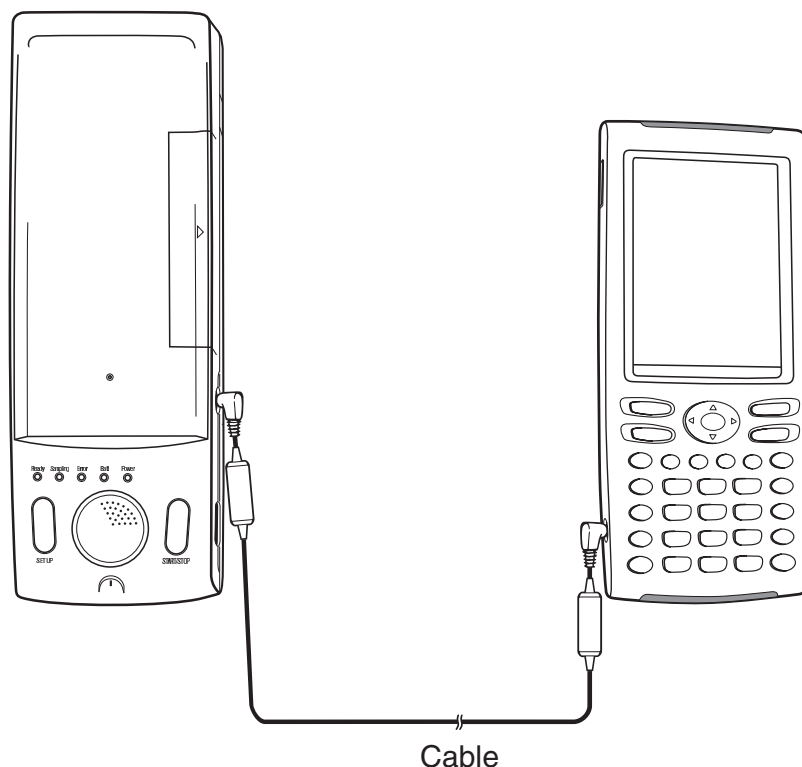

- For information about what you should do to transfer data, see the user documentation that comes with the Data Analyzer.



Connecting to a Computer (USB)

By running FA-CP1 software that comes with ClassPad on your computer, you can transfer ClassPad data to your computer.

See the FA-CP1 User's Guide for information about how to use it.

- For information about FA-CP1 minimum computer system requirements, see the FA-CP1 User's Guide.

■ Required Hardware

ClassPad: 1 unit

Computer (with FA-CP1 installed): 1

Special USB Cable: 1

● ClassPad Operation

- (1) Turn off the ClassPad and computer.
- (2) Connect one end of the special cable that comes with the ClassPad to the USB port of your computer.
 - See the FA-CP1 User's Guide for details about how to connect the cable to your computer.
- (3) Connect the other end of the special cable as shown below.

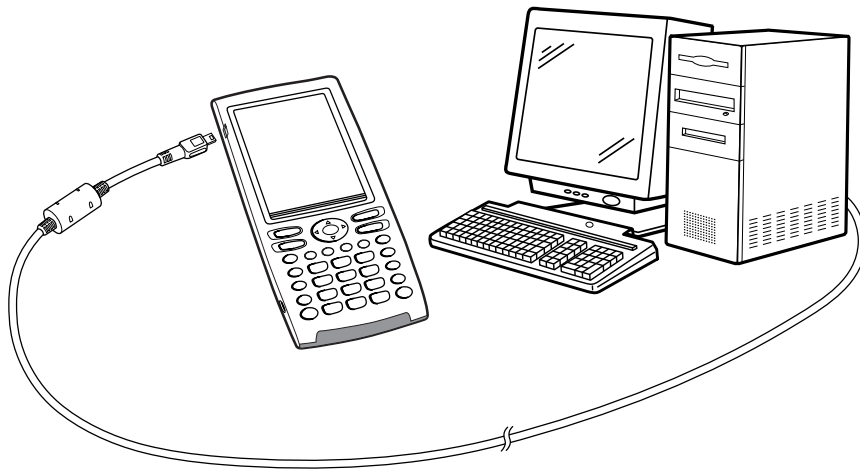

- For information about what you should do to actually transfer data, see the FA-CP1 User's Guide.



17-3 Configuring Communication Parameters

Before trying to transfer data with the ClassPad, you should perform the procedures described in this section to configure its data communication parameters.

• ClassPad Operation

(1) On the application menu, tap .

- This starts the Communication application and displays a window that shows its current communication parameter settings.

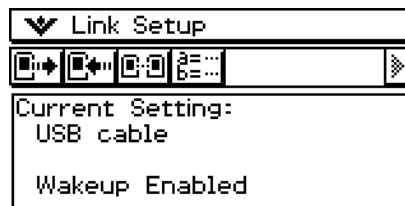

(2) Tap [Setup] and then [Open Setup Menu].

- This displays a dialog box for changing communication parameters, like the one shown below.

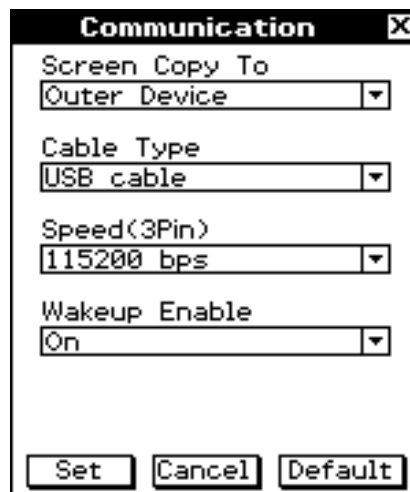

(3) Configure the communication parameter settings as described below.

- Items marked with an asterisk (*) are initial defaults.

• Screen Copy To

Specify "Outer Device".

• Cable Type

When connecting to this type of device:	Select this setting:
Another ClassPad unit or a Data Analyzer	3pin cable
A computer's USB port	USB cable*



- **Speed (3Pin)**

To specify this data rate for 3-pin communication:	Select this setting:
9600 bps	9600 bps
38400 bps	38400 bps
115200 bps	115200 bps*

The above setting specifies the data rate when connected to another ClassPad, or a Data Analyzer. Note that you must set the data rate (baud rate) for both the ClassPad and the connected device so they are identical.

- **Wakeup Enable**

To do this:	Select this setting:
Turn on the wakeup function (see below)	On*
Turn off the wakeup function	Off

(4) When all the settings are the way you want, tap [Set] to save them.

- The Communication application window appears at this time, with the new parameters you just configured. Check to make sure the settings are the way you want.

Tip

- For more information about the communication parameter, see “Communication Dialog Box” on page 1-9-15.

Wakeup

Wakeup is a function that automatically puts the ClassPad into data communication standby whenever the ClassPad detects data coming in from a connected external device, or when a USB cable is attached to the ClassPad. You can turn wakeup on or off with the [Wakeup Enable] setting on the Communication dialog box described on page 1-9-15. What happens when wakeup is turned on depends on the type of device connected to the ClassPad.

■ When connected to another ClassPad unit

When the sending device performs a data send operation, the receiver device’s wakeup function activates and data receive is performed automatically. The receiver device operates normally as long as no data is being received.

In this configuration, wakeup does not operate on the receiver device when any one of the following three conditions exists.

- When any setting other than “3pin cable” is selected for [Cable Type] on the Communication dialog box.
- When any ongoing calculation or graphing operation is being performed. Wakeup activates when the ongoing operation is complete.
- When the ClassPad is completely powered down. For details, see “1-2 Turning Power On and Off ”



■ When connected to a computer's USB port

Wakeup activates as soon as you connect the cable to the ClassPad, and the ClassPad automatically performs the following steps.

- (1) If the ClassPad is off when the cable is connected, it turns on.
- (2) The currently running application is exited, and the Communication application starts up.
 - If the Communication application is already running at this time, it restarts.
- (3) The ClassPad enters communication standby.
 - For information about what you should do to actually transfer data, see the FA-CP1 User's Guide.

In this configuration, wakeup does not operate when any one of the following conditions exists.

- When any setting other than "USB cable" is selected for [Cable Type] on the Communication dialog box.
- When any ongoing calculation or graphing operation is being performed. Wakeup activates when the ongoing operation is complete.
- When the ClassPad is completely powered down. For details, see "1-2 Turning Power On and Off".

Note that wakeup does not activate in the case of add-in application or language data installation, or upgrading of the operating system.

Important!

- Connecting a USB cable to the ClassPad activates wakeup, exits the currently running application, and puts the ClassPad into communication standby. If you want to send a screenshot of the current display (page 17-4-5) or perform some other operation in which you want the currently running application to remain running, use the [Setup] - [Open Setup Menu] command to turn off wakeup (Wakeup Enable: Off).
- Wakeup may not work properly when both an SB-62 cable and a USB cable are connected to the ClassPad.
- For about five seconds after the display image disappears from the ClassPad screen when you turn off power, do not connect a cable to or disconnect a cable from the ClassPad. If you do, it can cause the wakeup function to operate abnormally.



17-4 Transferring Data to Another ClassPad Unit

This section details the steps you should perform in order to transfer data from one ClassPad unit to another.

• ClassPad Operation

- (1) Use the procedure under “Connecting to Another ClassPad Unit” on page 17-2-1 to connect the two units.
- (2) Use the procedure under “17-3 Configuring Communication Parameters” to configure the parameters of the two units as shown below.

Cable Type: 3pin cable
 Speed (3Pin): 115200 bps
 Wakeup Enable: On

- If the speed settings of the two ClassPad units are different from each other, the slower setting is used.

The remaining steps of this procedure are marked *Sender* to indicate steps and information that apply to the sending device, or *Receiver* to indicate receiving device steps and information.

Sender

- (3) In the Communication application, tap [Link], and then [Transmit], or tap .

- This displays the Select Data dialog box.

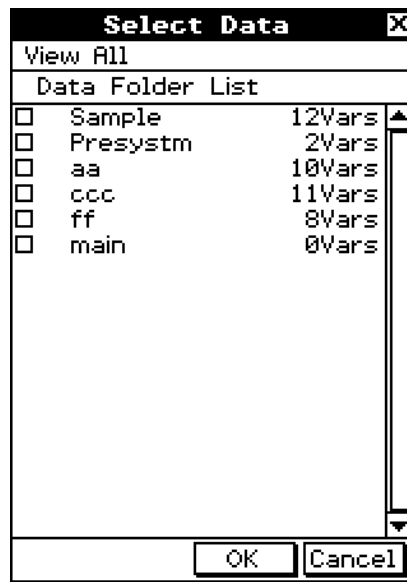

Sender

- (4) Select the data you want to send.

- For more information, see “Selecting Data for Transfer” on page 17-4-3.

Sender

- (5) Tap [OK].



Sender

(6) In response to the confirmation message that appears, tap [OK] to send the data or [Cancel] to cancel the send operation.

- **Sender**

Tapping [OK] sends the data you selected in step (4).

- **Receiver**

If the receiving device has wakeup enabled, it automatically starts receiving the data.

Sender

(7) The message “Complete!” appears to let you know when the send operation is finished. Tap [OK].

- This returns to the Select Data dialog box.

Sender

(8) On the Select Data dialog box, tap [Cancel].

- This returns to the Communication application window.

Receiver

(9) The message “Complete!” appears to let you know when the receive operation is finished. Tap [OK].

Important!

- When wakeup is turned off on the receiving device, you need to perform the following operation on the receiving device before performing step (3):
Start up the Communication application, tap [Link] and then [Receive], or tap .
This puts the receiving unit into receive standby, which is indicated by the Standby dialog box on the display.

Tip

- When you send a variable or data item, it is normally stored in the current folder of the receiving device. A variable or data item sent from the library folder of the sending device, however, is stored in the “library” folder of the receiving device.
- When you send a folder (by selecting the check box next to a folder name), the variables and data items inside each folder are sent and stored in folders with the same name on the receiving device.
- If a data item with the same name as the data item being received already exists on the receiving device, the communication operation is paused and a dialog box asking whether the existing item should be replaced appears on the display of the receiving device. Tap [Yes] to replace, or [No] to cancel receipt of the data item. To terminate data communication, tap [Cancel]. If you want to replace all data items without being asked, tap [Yes to all].
- If the receiving device runs out of memory, a message dialog box appears to warn you. When this happens, terminate the data communication operation by tapping [OK] on the dialog box of the receiving device, delete data you no longer need from the memory of the receiving device, and then try again.



Selecting Data for Transfer

Perform the following steps on the sending device to select the data you want to send in step (3) of the procedure on page 17-4-1.

• ClassPad Operation

(1) In the Communication application, tap [Link] and then [Transmit], or tap  to display the Select Data dialog box.

- A list that shows user folders and the “main” folder appears first.

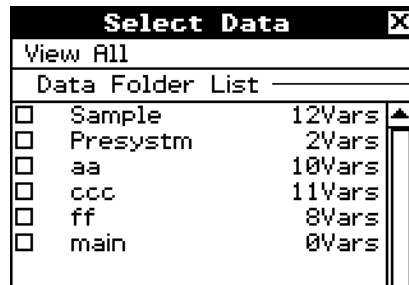

Title of currently displayed list
(folder name when a folder is open)

(2) Tap the [View] menu and then select the data type from the list that appears.

To list this on the Select Data dialog box:	Select this [View] menu command:
User folders and the “main” folder	Data Folder List
Library variables	Library
System variable groups	Application Status
eActivity folders	eActivity Folder List

(3) Select the data you want to send.

- On the Select Data dialog box, select the check box next to the data you want to send.
- You can also tap the [All] menu and select one of the following commands to select or deselect data.

To do this:	Select this [All] menu command:
Select all currently displayed items	Select List
Deselect all currently displayed items	Deselect List
Select all items in all lists	Select All Lists
Deselect all items in all lists	Deselect All Lists

- Opening a folder in [Data Folder List] or [eActivity Folder List] displays the variables and data contained inside it, which can be individually selected for transfer. To select a variable or data contained in a particular folder, tap its folder name to open it.



Data Folder List

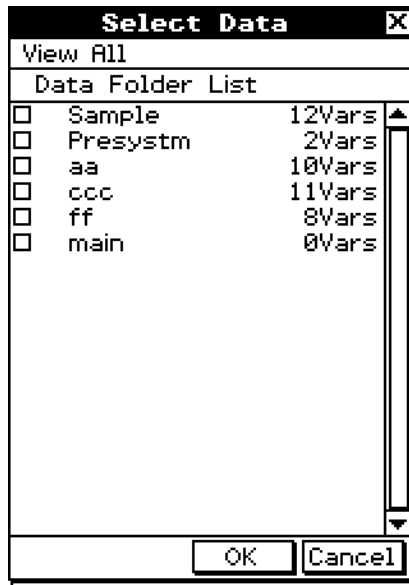

Tap "Presystm" to highlight it, and then tap it again.

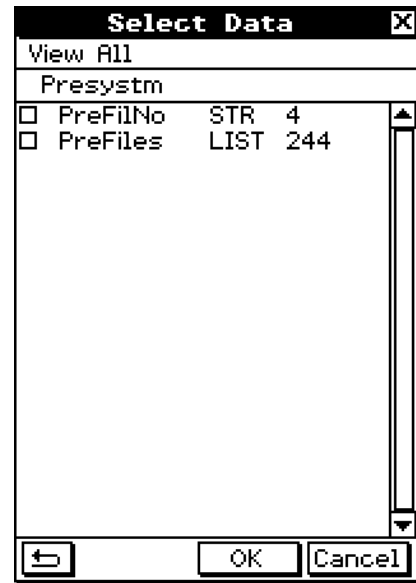

This lists the variables contained in the "Presystm" folder.

eActivity Folder List

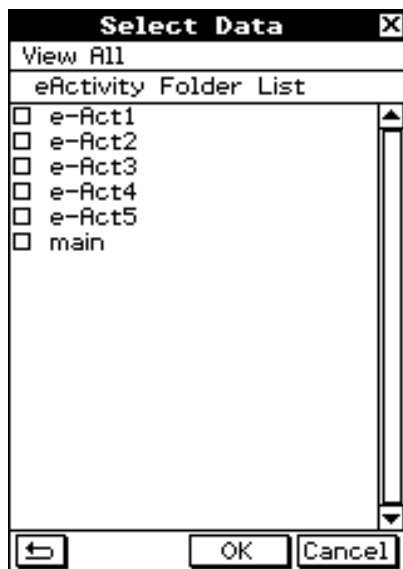

Tap "e-Act2".

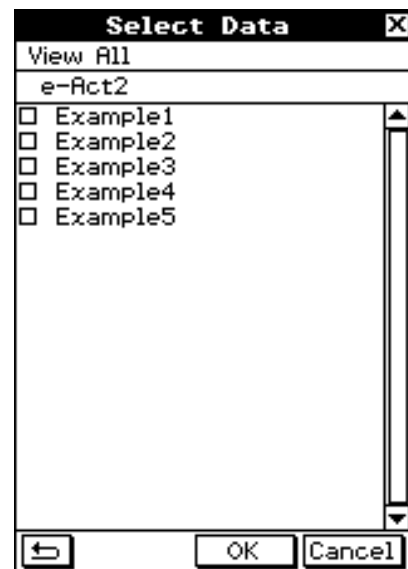

This lists the data contained in the "e-Act2" folder.

- To return to the folder list from a list of folder contents, tap  in the lower left corner of the window.
- You can transfer all of the variables or data in a folder by selecting the check box next to the folder name on the data folder list or eActivity folder list.

(4) Tap [OK] to send the data or [Cancel] to cancel the send operation.

- After tapping [OK], continue from step (5) of the procedure on page 17-4-1.



Sending a Screenshot of the Current Display Contents

Use the following procedure to send the current display contents of your ClassPad to another ClassPad unit.

Important!

Screenshot transfer is disabled when either of the following conditions exists.

- While a calculation or graphing operation is in progress
- If a data communication operation is already in progress

• **ClassPad Operation**

- (1) Use the procedure under “Connecting to Another ClassPad Unit” on page 17-2-1 to connect the two units.
- (2) Use the procedure under “17-3 Configuring Communication Parameters” to configure the parameters of the two units as shown below.

Cable Type: 3pin cable

Speed (3Pin): 115200 bps

Wakeup Enable: On

Screen Copy To: Outer Device (Sending device only)

The remaining steps of this procedure are marked *Sender* to indicate steps and information that apply to the sending device, or *Receiver* to indicate receiving device steps and information.

Sender

- (3) Display the screen you want to send.

- (4) Tap  .

- *Sender*

This sends the currently displayed screen.

- *Receiver*

If the receiving device has wakeup enabled, it automatically starts receiving the data.

The received screen appears on the display after the receive operation is complete.

Sender

- (5) If you want to send another screenshot, repeat steps (3) and (4).

Receiver

- (6) To cancel a receive standby state, press the  key.

Important!

- When wakeup is turned off on the receiving device, you need to perform the following operation on the receiving device before performing step (4):
Start up the Communication application, tap [Link], and then [Screen Receive], or tap  .
This puts the receiving unit into receive standby, which is indicated by the Standby dialog box on the display.

Tip

- Note that received screenshots can be displayed, but not saved.



Communication Standby

The ClassPad enters “communication standby” when you perform a send or receive operation. While in communication standby, the ClassPad waits for the other unit to send data, or for it to get ready to receive data.

The following describes how communication standby affects certain ClassPad operations.

- Auto Power Off (page 16-6-1) becomes disabled.
- ClassPad power cannot be turned off.
- If data communication does not start within three minutes after the ClassPad enters data communication standby, the message “Timeout” appears. When this happens, tap [Retry] to try again or [Cancel] to cancel the data communication operation.

Interrupting an Ongoing Data Communication Operation

Pressing the  key on either the sending device or receiving device during a data communication operation terminates it.



Appendix

- 1 Resetting and Initializing the ClassPad**
- 2 Deleting an Application**
- 3 Power Supply**
- 4 Number of Digits and Precision**
- 5 Specifications**
- 6 Character Code Table**
- 7 System Variable Table**
- 8 Command and Function Index**
- 9 Graph Types and Executable Functions**
- 10 Error Message Table**



1 Resetting and Initializing the ClassPad

The memory of your ClassPad is divided into three parts: main memory, a storage area for storing data, and a RAM area for executing various calculations and operations. Reset and initialize restore normal ClassPad operation after some problem occurs.

RAM Reset

Perform RAM reset when the ClassPad freezes up or otherwise fails to perform as expected for some reason. A RAM reset does not affect data stored in main memory or the storage area, but it clears any data stored in the RAM area.

Memory Reset

Memory reset deletes all variable data in main memory or all eActivity data in the storage area, or both.

Memory Initialize

Initializing memory deletes all data and returns ClassPad memory to its initial factory default state. When initializing memory, you will be able to specify whether or not you also want to delete add-in applications.

This section explains how to perform the RAM reset operations only. The memory reset and memory initialize operations are performed using the System application. For details, see “16-3 Using the Reset Dialog Box” and “16-4 Initializing Your ClassPad”.



■ Performing the RAM Reset Operation

You should perform the RAM reset operation whenever your ClassPad freezes up or when it begins to operate abnormally for some reason. The RAM reset operation should restore normal ClassPad operation.

Important!

- The RAM reset operation deletes all data that is temporarily stored in ClassPad RAM. Performing the RAM reset operation while a calculation is in progress will cause any data stored in RAM by the calculation to be lost.
- Perform the RAM reset operation only when your ClassPad ceases to operate normally for some reason.

● ClassPad Operation

(1) Use the stylus to press the P button on the back of the ClassPad.

- Following the RAM reset operation, the ClassPad restarts automatically.

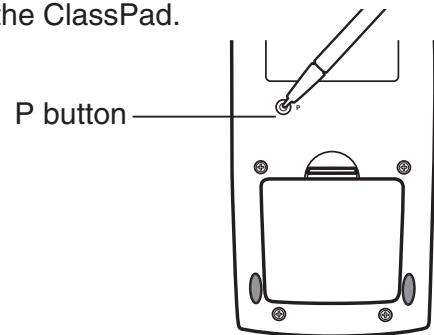

(2) After the ClassPad restarts, perform the ClassPad setup operation that you perform each time you replace ClassPad batteries (touch panel alignment, display contrast adjustment, display message language selection, keyboard settings). See Chapter 16 for more information about the ClassPad setup operation.



- The application menu appears after you finish the setup operation.



2 Deleting an Application

You can delete an add-in application by deleting it from the application menu or by using the [Add-In App.] Memory Usage sheet of the System application as described in Chapter 16. The following procedure shows how to delete an add-in application from the application menu only. For information about using the System application's [Add-In App.] tab, see Chapter 16.

• To use the application menu to delete an add-in application

- (1) Tap  to display the application menu.
- (2) Tap the down arrow button in the menu bar, and then select [Additional] from the list that appears.
 - This displays a list of all the applications you have installed on your ClassPad.
- (3) Tap , and then tap [Delete Application] on the menu that appears.
 - This causes all of the icons to be surrounded by a broken line, indicating that your ClassPad is ready to delete applications.
 - To exit the delete operation at this time, tap **ESC** on the icon panel.
- (4) Tap the icon of the application you want to delete.
- (5) In response to the dialog box that appears, tap [OK] to delete the application, or [Cancel] to cancel without deleting anything.

Tip

- Note that you can delete only add-in applications. You cannot delete any of the ClassPad's built-in applications.
- If you prefer to view remaining memory capacity as you delete add-in applications, use the [Add-In App.] Memory Usage sheet of the System application as described in Chapter 16.





3 Power Supply

Your ClassPad is powered by four AAA-size batteries LR03 (AM4).

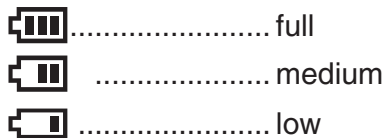
The battery level indicator is displayed in the status bar.



Important!

- Be sure to replace batteries as soon as possible whenever the battery level indicator shows  (medium).
- Replace batteries immediately whenever the battery level indicator shows  (low). At this level, you will not be able to perform data communication or perform other functions.
- The following message indicates that batteries are about to go dead. Replace batteries immediately whenever this message appears.

Batteries are extremely low!
Replace batteries immediately!

If you try to continue using the calculator, it will automatically turn off. You will not be able to turn power back on until you replace batteries.

Be sure to replace batteries at least once every one year, no matter how much you use the ClassPad during that time.

The batteries that come with this ClassPad discharge slightly during shipment and storage. Because of this, they may require replacement sooner than the normal expected battery life.

Backing Up Data

Your ClassPad comes bundled with a special USB cable and FA-CP1 software, which you can use to backup data to a computer running Windows[®] 98 SE, Windows[®] Me, Windows[®] XP, Windows[®] 2000, or Windows Vista[®].

- The FA-CP1 software is on the CD-ROM.

Important!

- When battery power is very low, your ClassPad may not turn back on when you press its  key. If this happens, immediately replace its batteries.



■ Replacing Batteries

Precautions:

Incorrectly using batteries can cause them to burst or leak, possibly damaging the interior of the ClassPad. Note the following precautions:

- Be sure that the positive (+) and negative (–) poles of each battery are facing in the proper directions.
- Never mix batteries of different types.
- Never mix old batteries and new ones.
- Never leave dead batteries in the battery compartment.
- Remove the batteries if you do not plan to use the ClassPad for long periods.
- Never try to recharge the batteries supplied with the ClassPad.
- Do not expose batteries to direct heat, let them become shorted, or try to take them apart. (Should a battery leak, clean out the battery compartment of the ClassPad immediately, taking care to avoid letting the battery fluid come into direct contact with your skin.)

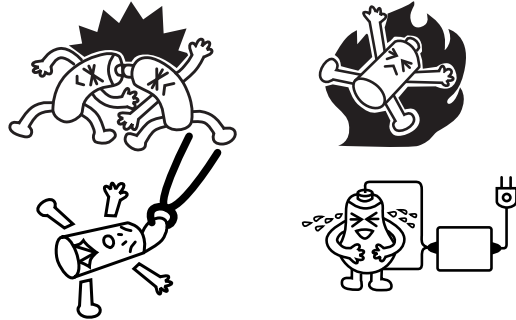

Keep batteries out of the reach of small children. If swallowed, consult with a physician immediately.

● ClassPad Operation

- (1) Press **ON/OFF** to turn off the ClassPad.

Warning!

- Be sure to turn the ClassPad off before replacing batteries. Replacing batteries with power on will cause data in memory to be deleted.

- (2) Making sure that you do not accidentally press the **ON/OFF** key, attach the front cover to the ClassPad and then turn it over.

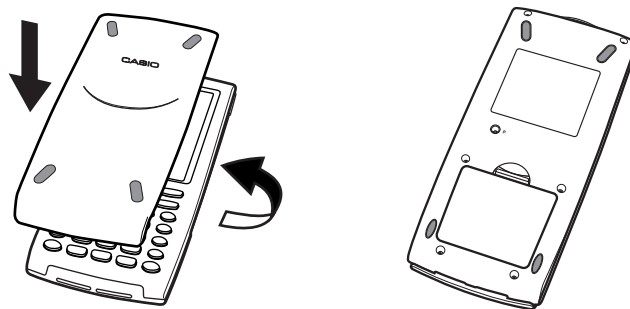

(3) Remove the battery cover from the ClassPad by pulling with your finger at the point marked ①.

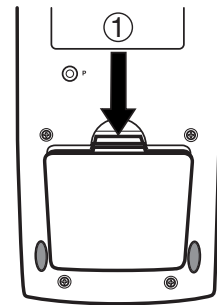

(4) Remove the four old batteries.

(5) Load a new set of four batteries, making sure that their positive (+) and negative (-) ends are facing in the proper directions.

- Be sure to replace all four batteries with new ones.

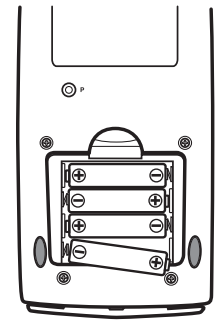

(6) Replace the battery cover.

(7) Turn the ClassPad front side up and remove its front cover.

(8) Align the touch panel.

a. Your ClassPad should turn on automatically and display the Touch Panel Alignment screen.

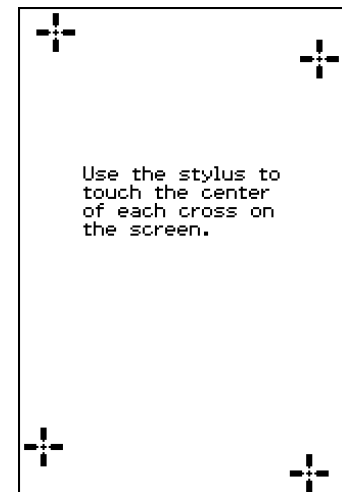

b. Tap the center of each of the four cross marks as they appear on the display.



- If the Touch Panel Alignment screen does not appear, use the stylus to press the P button on the back of the ClassPad.

Important!

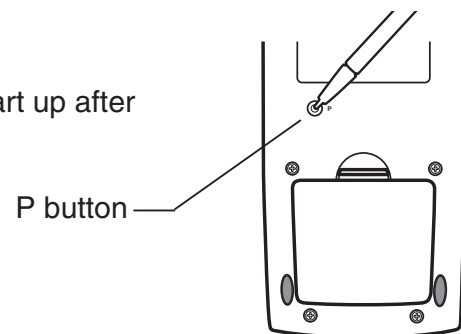
- It may take a little time for your ClassPad to start up after you press the P button.



(9) Adjust the display contrast.

- a. Tap the  button to make contrast darker, or the  button to make it lighter.
- b. After the contrast setting is the way you want, tap [Set].
 - Tapping [Initial] on the Contrast dialog box returns contrast to its initial factory default setting.

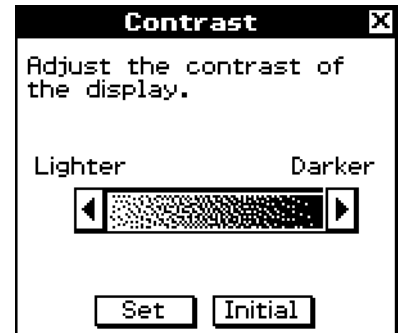

(10) Specify the display language.

- a. On the list that appears, tap the language you want to use.
 - You can select German, English, Spanish, French, or Portuguese.
- b. When the language you want is selected, tap [Set].
 - Tapping [Cancel] selects English and advances to the next dialog box.

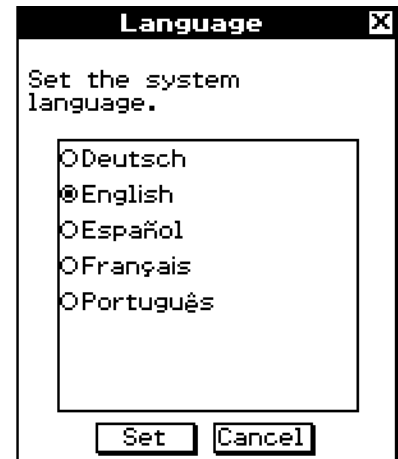

(11) Specify the soft keyboard key arrangement.

- a. On the list that appears, tap the key arrangement you want to use.
- b. When the key arrangement you want is selected, tap [Set].
 - Tapping [Cancel] selects QWERTY arrangement and advances to the next dialog box.



(12) Specify the font set.

- a. On the list that appears, tap the font set you want to use.
 - You can select Regular or Bolder.
- b. When the font set you want is selected, tap [Set].
 - Tapping [Cancel] selects Bolder and advances to the next dialog box.

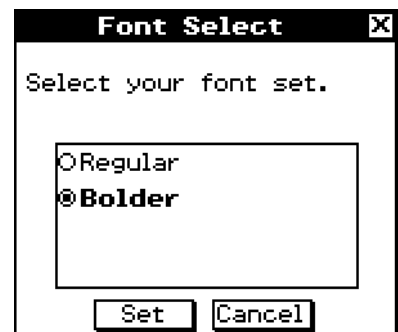

(13) Configure power properties.

- a. Configure the Power Save Mode and Auto Power Off settings.
 - See “Power Saving Mode” and “Auto Power Off” on page 16-6-1 for details about these settings.
- b. When the configurations are the way you want, tap [Set].
 - Tapping [Cancel] selects “1 day” for [Power Save Mode] and “6 min” for [Auto Power Off], and finalizes the setup operation.

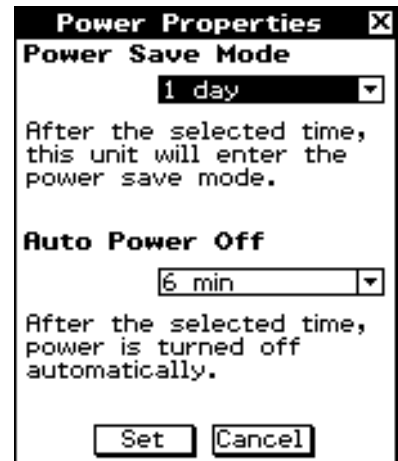

■ About the Auto Power Off Function

The Auto Power Off (APO) feature helps conserve battery power by turning off the ClassPad automatically whenever you do not perform any operation for specified amount of time. You can specify 1, 3, 6, or 60 minutes for the Auto Power Off trigger time. The initial default APO setting is 6 minutes.

Tip

- From within the System application, open the System menu and tap [Power Properties]. This will display the Power Properties dialog box.



4 Number of Digits and Precision

■ Number of Digits

Standard Mode

The following applies when the check box next to the “Decimal Calculation” item on the Basic Format dialog box is not selected.

- Up to 611 digits are stored in memory for integer values.
- Decimal values up to 15 digits are converted to fraction format and saved in memory. When a mathematical expression cannot be converted to fraction format, the result is displayed in decimal format.
- Values stored in memory are displayed as-is, regardless of how [Number Format] settings (Normal 1, Normal 2, Fix 0 – 9, Sci 0 – 9) are configured (except when a decimal value is displayed).

Decimal Mode

The following applies when the check box next to the “Decimal Calculation” item on the Basic Format dialog box is selected.

- Values stored in Ans memory and values assigned to variables have the same number of digits as defined for Standard mode values.
- Values are displayed in accordance with how [Number Format] settings (Normal 1, Normal 2, Fix 0 – 9, Sci 0 – 9) are configured.
- Displayed values are rounded to the appropriate number of decimal places.
- Some applications store values using a mantissa up to 15 digits long and a 3-digit exponent.

■ Precision

- Internal calculations are performed using 15 digits.
- The error for a single mathematical expression (Decimal mode calculation error) is ± 1 at the 10th digit. In the case of exponential display, calculation error is ± 1 at the least significant digit. Note that performing consecutive calculations causes error to be cumulative. Error is also cumulative for internal consecutive calculations performed for: $\wedge(x^y)$, $\sqrt[x]{}$, $x!$, nPr , nCr , etc.
- Error is cumulative and tends to be larger in the vicinity of a function’s singular point(s) and inflection point(s), and the vicinity of zero. With $\sinh(x)$ and $\tanh(x)$, for example, the inflection point occurs when $x = 0$. In this vicinity, error is cumulative and precision is poor.



5 Specifications

Calculation range:

$\pm 1 \times 10^{-999}$ to $\pm 9.999999999 \times 10^{999}$ and 0. Internal operations use 15-digit mantissa.

Exponential display range: Normal 1: $10^{-2} > |x|, |x| \geq 10^{10}$

Normal 2: $10^{-9} > |x|, |x| \geq 10^{10}$

Program capacity: 515000 bytes (max.)

Power supply:

Four AAA-size batteries LR03 (AM4)

Power consumption: 0.5 W

Approximate battery life:

230 hours (continuous display of application menu)

140 hours continuous operation (5 minutes calculation, 55 minutes display)

Auto power off:

Power is automatically turned off if no operation is performed for a specified period (user-settable as 1 minute, 3 minutes, 6 minutes, or 60 minutes). The initial default setting is 6 minutes.

Power saving mode:

Resume function can be configured to stay enabled, or to disable automatically 1 hour, 6 hours, or 1 day after power is turned off.

Ambient temperature range: 0°C to 40°C

Dimensions: 21 mm (H) \times 84 mm (W) \times 189.5 mm (D)

$1\frac{3}{16}$ " (H) \times $3\frac{5}{16}$ " (W) \times $7\frac{7}{16}$ " (D)

Weight: Approx. 280 g (including batteries)



Data Communication

Port: 3-pin data communication port
4-pin mini USB port

- For information about FA-CP1 minimum computer system requirements, see the FA-CP1 User's Guide.

Method: Start-stop (asynchronous), full-duplex

Transmission speed (BPS): 115200/38400/9600 bits/second (normal)
38400 bits/second (Send38k/Receive38k)

Parity: None

Bit length: 8 bits

Stop bit:

Send38k: 2 bits

Receive38k: 1 bit

Flow control: X ON



6 Character Code Table

Characters from character code 257 onwards are 2-byte characters.

32		48	Ø	64	Ⓔ	80	P	96	˘	112	Ɔ
33	!	49	1	65	A	81	Q	97	a	113	q
34	"	50	2	66	B	82	R	98	b	114	r
35	#	51	3	67	C	83	S	99	c	115	s
36	\$	52	4	68	D	84	T	100	d	116	t
37	%	53	5	69	E	85	U	101	e	117	u
38	&	54	6	70	F	86	V	102	f	118	v
39	,	55	7	71	G	87	W	103	g	119	w
40	(56	8	72	H	88	X	104	h	120	x
41)	57	9	73	I	89	Y	105	i	121	y
42	*	58	:	74	J	90	Z	106	j	122	z
43	+	59	;	75	K	91	[107	k	123	{
44	,	60	<	76	L	92	\	108	l	124	
45	-	61	=	77	M	93]	109	m	125	}
46	.	62	>	78	N	94	^	110	n	126	~
47	/	63	?	79	O	95	_	111	o		

257	À	270	Í	283	Ô	296	Ö	309	ÿ	322	Ń
258	Á	271	Î	284	Û	297	Ð	310	İ	323	Ŋ
259	Â	272	Ï	285	Ý	298	Ē	311	ÿ	324	Ň
260	Ã	273	Ð	286	Ɔ	299	Ě	312	ı	325	Đ
261	Ä	274	Ñ	287	Ɔ	300	É	313	ı	326	Ī
262	Å	275	Ò	288	ÿ	301	Ě	314	ı	327	Š
263	Æ	276	Ó	289	Ā	302	Ě	315	ı	328	Š
264	Ç	277	Ô	290	Ā	303	Ğ	316	ı	329	Œ
265	È	278	Š	291	Ā	304	Ğ	317	ı	330	Ř
266	É	279	Ö	292	Č	305	Ğ	318	ı	331	Ř
267	Ê	280	Ø	293	Č	306	Ğ	319	ı	332	Ř
268	Ë	281	Ù	294	Č	307	Ĥ	320	ı	333	Š
269	İ	282	Ú	295	Č	308	Ĥ	321	ı	334	Š



α-6-2
Character Code Table

335	Ş	358	Ó	381	Ψ	404	Φ	427	Κ	487	ƶ
336	Ξ	359	Α	382	Ω	405	Χ	428	Λ	488	Β
337	Τ	360	Β	383	Α	406	Ц	429	Μ	489	Ƴ
338	Υ	361	Γ	384	Б	407	Ч	430	Ν	490	+
339	ƒ	362	Δ	385	В	408	Ш	431	Ο	491	-
340	Û	363	Ε	386	Г	409	Щ	432	Ρ	496	◊
341	Ū	364	Ζ	387	Д	410	Ъ	433	Q	497	1
342	Ö	365	Η	388	Ε	411	Ы	434	℞	498	2
343	Ô	366	Θ	389	Ë	412	Ь	435	Ŝ	499	3
344	Ü	367	Ι	390	Ж	413	Э	436	Ƨ	500	4
345	Ÿ	368	Κ	391	З	414	Ю	437	U	501	5
346	Ŵ	369	Λ	392	И	415	Я	438	∇	502	6
347	Ϛ	370	Μ	393	Й	416	Є	439	W	503	ƶ
348	ž	371	Ν	394	К	417	А	440	X	504	8
349	ž	372	Ξ	395	Л	418	Б	441	Y	505	9
350	ž	373	Ο	396	М	419	С	442	Z	506	+
351	Œ	374	Π	397	Н	420	Ɔ	480	◊	507	-
352	Ÿ	375	Ρ	398	Ο	421	Ǝ	481	1	508	-1
353	Ǻ	376	Σ	399	Π	422	Ƒ	482	2	509	m
354	ÿ	377	Τ	400	Ρ	423	Ɠ	483	3	510	◊
355	ö	378	Υ	401	С	424	ℋ	484	4		
356	Û	379	Φ	402	Т	425	ℓ	485	5		
357	Ü	380	Χ	403	У	426	ℓ	486	6		

513	à	524	ë	535	ö	546	ǻ	557	ƣ	568	ı
514	á	525	ì	536	ø	547	ǻ	558	ë	569	ı
515	â	526	í	537	ù	548	ć	559	ê	570	ij
516	ã	527	î	538	ú	549	ê	560	ë	571	ĵ
517	ä	528	ï	539	û	550	è	561	é	572	ķ
518	å	529	ð	540	ü	551	č	562	ś	573	ı
519	æ	530	ñ	541	ý	552	d'	563	ś	574	ł
520	ç	531	ò	542	þ	553	đ	564	ћ	575	ł'
521	è	532	ó	543	ß	554	ē	565	ŷ	576	ł
522	é	533	ô	544	ÿ	555	ě	566	ŧ	577	ł'
523	ê	534	õ	545	ā	556	è	567	ŷ	578	ń



α-6-3
Character Code Table

579	᠋	604	ž	629	o	654	o	679	g	741	ʹ
580	ň	605	ž	630	π	655	п	680	h	742	x
581	᠋	606	ž	631	ρ	656	р	681	i	743	y
582	ō	607	oʻ	632	ó	657	с	682	j	744	i
583	ö	608	uʻ	633	т	658	т	683	k	745	j
584	ö	609	ä	634	u	659	у	684	l	746	k
585	œ	610	ÿ	635	φ	660	φ	685	m	752	o
586	ř	611	ö	636	x	661	x	686	n	753	l
587	ř	612	ü	637	φ	662	ц	687	o	754	z
588	ř	613	ü	638	ω	663	ч	688	p	755	z
589	š	614	ú	639	а	664	ш	689	q	756	4
590	š	615	œ	640	б	665	щ	690	r	757	5
591	š	616	β	641	в	666	ъ	691	s	758	6
592	š	617	γ	642	г	667	ы	692	t	759	7
593	š	618	ó	643	д	668	ь	693	u	760	8
594	tʻ	619	ε	644	e	669	э	694	v	761	9
595	tʻ	620	ζ	645	ë	670	ю	695	w	762	+
596	ü	621	η	646	ж	671	я	696	x	763	-
597	ü	622	θ	647	з	672	ε	697	y	764	-1
598	ü	623	ι	648	и	673	α	698	z	765	x
599	ú	624	κ	649	ñ	674	b	736	z	766	y
600	ü	625	λ	650	к	675	c	737	ʻ		
601	ч	626	μ	651	л	676	d	738	ʻ		
602	ô	627	ν	652	м	677	e	739	ʻ		
603	ö	628	ξ	653	н	678	f	740	ç		

769	ı	778	n	787	≥	796	≡	805	⊥	814	”
770	e	779	∠	788	±	797	с	806	≡	815	“
771	E	780	̄	789	÷	798	с	807	᠋	816	€
772	π	781	ȳ	790	≡	799	u	808	᠋	817	▲
773	ω	782	ř	791	≡	800	п	809	Δ	818	-
774	o	783	⇒	792	≡	801	л	810	∴	819	N
775	р	784	×	793	≡	802	у	811	∴	820	Z
776	т	785	≠	794	≡	803	у	812	‘	821	Q
777	ʻ	786	≤	795	≡	804	а	813	’	822	R



α-6-4
Character Code Table

823	©	844	∞	864	⚠	884		904	◀	924	↶
824	™	845	≅	865	°C	885	!	905	○	925	↑
825	/	846	≠	866	°F	886	[906	⊗	926	↵
826	\	847	α	867	←	887]	907	⊙	927	↗
827	^	848	√	868	↑	888	△	908	●	928	↘
828	~	849	Σ	869	→	889	♪	909	⊞	929	←
829	°	850	Π	870	↓	890	♫	910	⊠	930	⊕
830	≡	851	∫	871	↔	891	♬	911	...	931	⊖
831	□	852	∫	872	↕	892	♭	912	...	932	⊗
832	〒	853	φ	873	↖	893	□	913	▪	933	⊘
833	≈	854	∂	874	↗	894	■	914	•	934	ℙ
834	⊕	855	∂	875	↘	895	⊞	915	×	935	ℚ
835	☺	856	∫	876	↙	896	♣	916	ℙ	936	ℤ
836	⊞	857	∫	877	¼	897	♣	917	↕	937	ℚ
837	℥	858	£	878	½	898	♥	918	↳	938	ℙ
838	≅	859	¥	879	¾	899	♦	919	↕	939	ℙ
839	≠	860	Fr	880	§	900	◇	920	⊠	940	⊞
840	∂	861	F	881	※	901	▲	921	♣	941	※
841	≅	862	€	882	¶	902	▶	922	!	943	∫
843	⚡	863	f	883	×	903	▼	923	+		



7 System Variable Table

○: Possible –: Not possible <blank>: No default

Name	Description	Input	Delete	Data Type	Default
a_0	Sequence Variable	○	–	EXPR (Real Number)	0
a_1	Sequence Variable	○	–	EXPR (Real Number)	0
a_2	Sequence Variable	○	–	EXPR (Real Number)	0
a_{Coef}	Regression Coefficient a	–	–	EXPR (Real Number)	
a_{cSeq}	Sequence Graph Trace Variable	–	–	EXPR (Real Number)	
a_n	Recursion Expression Variable	–	–	STR	
a_{n+1}	Recursion Expression Variable	○	○	STR	
a_{n+2}	Recursion Expression Variable	○	○	STR	
a_{n_0}	Recursion Internal Variable	–	–	EXPR (Real Number)	
a_{n_1}	Recursion Internal Variable	–	–	EXPR (Real Number)	
a_{n_2}	Recursion Internal Variable	–	–	EXPR (Real Number)	
$a_n\text{E}$	Sequence Expression	○	○	STR	
$a_n\text{E}_0$	Recursion Internal Variable	–	–	EXPR (Real Number)	
angle θ	Angle between Line of Vision and x -axis of 3D Graph View Window Value	○	–	EXPR (Real Number)	20
angle ϕ	Angle between Line of Vision and z -axis of 3D Graph View Window Value	○	–	EXPR (Real Number)	70
ans	Latest Result Output by Main/eActivity Applications	–	–	EXPR/LIST/MAT/STR	
$a_n\text{Start}$	Sequence Variable	○	–	EXPR (Real Number)	0
b_0	Sequence Variable	○	–	EXPR (Real Number)	0
b_1	Sequence Variable	○	–	EXPR (Real Number)	0
b_2	Sequence Variable	○	–	EXPR (Real Number)	0
b_{Coef}	Regression Coefficient b	–	–	EXPR (Real Number)	
b_{cSeq}	Sequence Graph Trace Variable	–	–	EXPR (Real Number)	
b_n	Recursion Expression Variable	–	–	STR	
b_{n+1}	Recursion Expression Variable	○	○	STR	
b_{n+2}	Recursion Expression Variable	○	○	STR	
b_{n_0}	Recursion Internal Variable	–	–	EXPR (Real Number)	
b_{n_1}	Recursion Internal Variable	–	–	EXPR (Real Number)	
b_{n_2}	Recursion Internal Variable	–	–	EXPR (Real Number)	

- Items in parentheses (()) indicate limiting conditions of corresponding data type.
- Braces ({ }) indicate items that can be specified for elements.



α -7-2
System Variable Table

Name	Description	Input	Delete	Data Type	Default
b_nE	Sequence Expression	○	○	STR	
b_nE_0	Recursion Internal Variable	–	–	EXPR (Real Number)	
b_nStart	Sequence Variable	○	–	EXPR (Real Number)	0
c_0	Sequence Variable	○	–	EXPR (Real Number)	0
c_1	Sequence Variable	○	–	EXPR (Real Number)	0
c_2	Sequence Variable	○	–	EXPR (Real Number)	0
$cCoef$	Regression Coefficient c	–	–	EXPR (Real Number)	
$ccSeq$	Sequence Graph Trace Variable	–	–	EXPR (Real Number)	
c_n	Recursion Expression Variable	–	–	STR	
c_{n+1}	Recursion Expression Variable	○	○	STR	
c_{n+2}	Recursion Expression Variable	○	○	STR	
c_{n0}	Recursion Internal Variable	–	–	EXPR (Real Number)	
c_{n1}	Recursion Internal Variable	–	–	EXPR (Real Number)	
c_{n2}	Recursion Internal Variable	–	–	EXPR (Real Number)	
c_nE	Sequence Expression	○	○	STR	
c_nE_0	Recursion Internal Variable	–	–	EXPR (Real Number)	
c_nStart	Sequence Variable	○	–	EXPR (Real Number)	0
ConicsEq	Conics Expression	○	○	STR	
$dCoef$	Regression Coefficient d	–	–	EXPR (Real Number)	
df	Degrees of Freedom	–	–	EXPR (Real Number)	
dfA	Degrees of Freedom for Factor A	–	–	EXPR (Real Number)	
$dfAB$	Degrees of Freedom for Factor A × Factor B	–	–	EXPR (Real Number)	
dfB	Degrees of Freedom for Factor B	–	–	EXPR (Real Number)	
$dfErr$	Degrees of Freedom for Error	–	–	EXPR (Real Number)	
$eCoef$	Regression Coefficient e	–	–	EXPR (Real Number)	
Expected	Expected Matrix for χ^2 Test	–	–	MAT{Real Number}	
FEnd	Table Creation Variable	○	–	EXPR (Real Number)	5
FResult	Table Result Variable	–	–	MAT	
FStart	Table Creation Variable	○	–	EXPR (Real Number)	1
FStep	Table Creation Variable	○	–	EXPR (Real Number)	1
Fvalue	F Value	–	–	EXPR (Real Number)	
FvalueA	F Value for Factor A	–	–	EXPR (Real Number)	
FvalueAB	F Value for Factor A × Factor B	–	–	EXPR (Real Number)	
FvalueB	F Value for Factor B	–	–	EXPR (Real Number)	
GconHEnd	Graph Transformation Vertical End Point	–	–	EXPR (Real Number)	5



α -7-3
System Variable Table

Name	Description	Input	Delete	Data Type	Default
GconHStart	Graph Transformation Vertical Start Point	–	–	EXPR (Real Number)	1
GconHStep	Graph Transformation Vertical Step Value	–	–	EXPR (Real Number)	1
GconWEnd	Graph Transformation Horizontal End Point	–	–	EXPR (Real Number)	5
GconWStart	Graph Transformation Horizontal Start Point	–	–	EXPR (Real Number)	1
GconWStep	Graph Transformation Horizontal Step Value	–	–	EXPR (Real Number)	1
HStart	Start Value for Histogram	○	–	EXPR (Real Number)	0
HStep	Step Value for Histogram	○	–	EXPR (Real Number)	1
LInterval	Lower Limit of Confidence Interval	–	–	EXPR (Real Number)	
list1	Default List	○	○	LIST	{ } (blank list)
list2	Default List	○	○	LIST	{ }
list3	Default List	○	○	LIST	{ }
list4	Default List	○	○	LIST	{ }
list5	Default List	○	○	LIST	{ }
list6	Default List	○	○	LIST	{ }
maxX	Maximum Value of x (Statistics Calculation)	–	–	EXPR (Real Number)	
maxY	Maximum Value of y (Statistics Calculation)	–	–	EXPR (Real Number)	
MeanSA	Mean Square for Factor A	–	–	EXPR (Real Number)	
MeanSAB	Mean Square for Factor A \times Factor B	–	–	EXPR (Real Number)	
MeanSB	Mean Square for Factor B	–	–	EXPR (Real Number)	
MeanSErr	Mean Square for Error	–	–	EXPR (Real Number)	
MedStat	Median Value (Statistics Calculation)	–	–	EXPR (Real Number)	
medx ₁	MedMed Graph Summary Point	–	–	EXPR (Real Number)	
medx ₂	MedMed Graph Summary Point	–	–	EXPR (Real Number)	
medx ₃	MedMed Graph Summary Point	–	–	EXPR (Real Number)	
medy ₁	MedMed Graph Summary Point	–	–	EXPR (Real Number)	
medy ₂	MedMed Graph Summary Point	–	–	EXPR (Real Number)	
medy ₃	MedMed Graph Summary Point	–	–	EXPR (Real Number)	
minX	Minimum Value of x (Statistics Calculation)	–	–	EXPR (Real Number)	
minY	Minimum Value of y (Statistics Calculation)	–	–	EXPR (Real Number)	



α -7-4
System Variable Table

Name	Description	Input	Delete	Data Type	Default
ModeFStat	Frequency of Mode Values (Statistics Calculation)	–	–	EXPR (Real Number)	
ModeNStat	Number of Mode Values (Statistics Calculation)	–	–	EXPR (Real Number)	
ModeStat	Mode Value (Statistics Calculation)	–	–	LIST {Real Number}	
MSe	Mean Square Error for Regression	–	–	EXPR (Real Number)	
n ₁ Stat	Size of Sample 1 (Statistics Calculation)	–	–	EXPR (Real Number)	
n ₂ Stat	Size of Sample 2 (Statistics Calculation)	–	–	EXPR (Real Number)	
ncSeq	Sequence Graph Trace Variable	–	–	EXPR (Real Number)	
nSeq	Sequence Variable	–	–	EXPR (Real Number)	
nStat	Sample Size (Statistics Calculation)	–	–	EXPR (Real Number)	
Observed	Observed Matrix for χ^2 Test	–	–	MAT {Real Number}	
\hat{p}	Estimated Proportion	–	–	EXPR (Real Number)	
\hat{p}^1	Estimated Proportion of Sample 1	–	–	EXPR (Real Number)	
\hat{p}^2	Estimated Proportion of Sample 2	–	–	EXPR (Real Number)	
prob	<i>p</i> -value	–	–	EXPR (Real Number)	
probA	<i>p</i> -value of Factor A	–	–	EXPR (Real Number)	
probAB	<i>p</i> -value of Factor A \times Factor B	–	–	EXPR (Real Number)	
probB	<i>p</i> -value of Factor B	–	–	EXPR (Real Number)	
Q ₁ Stat	First Quartile Point (Statistics Calculation)	–	–	EXPR (Real Number)	
Q ₃ Stat	Third Quartile Point (Statistics Calculation)	–	–	EXPR (Real Number)	
$r1(\theta)\sim r100(\theta)$	Graph Expression Input Variable, <i>r</i> = Expression Type	<input type="radio"/> (Define)	<input type="radio"/>	FUNC	
r^2 Corr	Coefficient of Determination	–	–	EXPR (Real Number)	
randResult	Internal Variable Used for Calculation of Next Random Number	–	–	EXPR (Real Number)	–1
rc	Graph Coordinate Value Storage Variable	–	–	EXPR (Real Number)	0
rCorr	Correlation Coefficient	–	–	EXPR (Real Number)	
residual	Residual Data Storage List	–	–	LIST {Real Number}	
Seed	Random Seed Value	–	–	EXPR (Real Number)	0
smin3D	3D Graph View Window Display <i>s</i> Minimum Value	<input type="radio"/>	–	EXPR(Real Number)	$-\pi$
smax3D	3D Graph View Window Display <i>s</i> Maximum Value	<input type="radio"/>	–	EXPR(Real Number)	π
s_p	Pooled Sample Standard Deviation	–	–	EXPR (Real Number)	
SqEnd	Sequence Creation Variable	<input type="radio"/>	–	EXPR (Real Number)	5



α -7-5
System Variable Table

Name	Description	Input	Delete	Data Type	Default
SqResult	Sequence Result Variable	–	–	MAT	
SqStart	Sequence Creation Variable	○	–	EXPR (Real Number)	1
Sres11	Calculation Result for StatGraph1	–	–	LIST {Real Number}	
Sres12	Calculation Result for StatGraph1	–	–	LIST {Real Number}	
Sres21	Calculation Result for StatGraph2	–	–	LIST {Real Number}	
Sres22	Calculation Result for StatGraph2	–	–	LIST {Real Number}	
Sres31	Calculation Result for StatGraph3	–	–	LIST {Real Number}	
Sres32	Calculation Result for StatGraph3	–	–	LIST {Real Number}	
Sres41	Calculation Result for StatGraph4	–	–	LIST {Real Number}	
Sres42	Calculation Result for StatGraph4	–	–	LIST {Real Number}	
Sres51	Calculation Result for StatGraph5	–	–	LIST {Real Number}	
Sres52	Calculation Result for StatGraph5	–	–	LIST {Real Number}	
Sres61	Calculation Result for StatGraph6	–	–	LIST {Real Number}	
Sres62	Calculation Result for StatGraph6	–	–	LIST {Real Number}	
Sres71	Calculation Result for StatGraph7	–	–	LIST {Real Number}	
Sres72	Calculation Result for StatGraph7	–	–	LIST {Real Number}	
Sres81	Calculation Result for StatGraph8	–	–	LIST {Real Number}	
Sres82	Calculation Result for StatGraph8	–	–	LIST {Real Number}	
Sres91	Calculation Result for StatGraph9	–	–	LIST {Real Number}	
Sres92	Calculation Result for StatGraph9	–	–	LIST {Real Number}	
sStat	Standard Error Value for LinReg TTest Calculation	–	–	EXPR (Real Number)	
SumSA	Sum of Squares for Factor A	–	–	EXPR (Real Number)	
SumSAB	Sum of Squares for Factor A \times Factor B	–	–	EXPR (Real Number)	
SumSB	Sum of Squares for Factor B	–	–	EXPR (Real Number)	
SumSErr	Sum of Squares for Error	–	–	EXPR (Real Number)	
S _x	Sample Standard Deviation of x (Statistics Calculation)	–	–	EXPR (Real Number)	
S _{x1}	Sample Standard Deviation of Data 1	–	–	EXPR (Real Number)	
S _{x2}	Sample Standard Deviation of Data 2	–	–	EXPR (Real Number)	
S _y	Sample Standard Deviation of y (Statistics Calculation)	–	–	EXPR (Real Number)	
tc	Graph Coordinate Value Storage Variable	–	–	EXPR (Real Number)	0
tLower	Result of TCD Calculation	–	–	EXPR (Real Number)	
tmin3D	3D Graph View Window Display t Minimum Value	○	–	EXPR(Real Number)	$-\pi$
tmax3D	3D Graph View Window Display t Maximum Value	○	–	EXPR(Real Number)	π



α -7-6
System Variable Table

Name	Description	Input	Delete	Data Type	Default
tUpper	Result of TCD Calculation	–	–	EXPR (Real Number)	
Tvalue	t Value	–	–	EXPR (Real Number)	
tθmax	View Window Tθ Maximum Value	○	–	EXPR (Real Number)	2π
tθmin	View Window Tθ Minimum Value	○	–	EXPR (Real Number)	0
tθStep	View Window Tθ Step Value Variable	○	–	EXPR (Real Number)	$\pi/60$
UInterval	Upper Limit of Confidence Interval	–	–	EXPR (Real Number)	
\bar{x}	Mean of x (Statistics Calculation)	–	–	EXPR (Real Number)	
xInv	Result of Inverse Cumulative Distribution Calculations	–	–	EXPR(Real Number)	
\bar{x}_1	Mean of Data 1	–	–	EXPR (Real Number)	
$x1(y)\sim x100(y)$	Graph Expression Input Variable, X= Type	○ (Define)	○	FUNC	
$x1InvN$	Result of InvNorm Calculation	–	–	EXPR (Real Number)	
\bar{x}_2	Mean of Data 2	–	–	EXPR (Real Number)	
$x2InvN$	Result of InvNorm Calculation	–	–	EXPR (Real Number)	
xc	Graph Coordinate Value Storage Variable	–	–	EXPR (Real Number)	0
xdot	View Window 1-dot x -axis Value	○	–	EXPR (Real Number)	0.1
xfact	Factor Zoom X-factor Value	○	–	EXPR (Real Number)	2
xgrid3D	3D Graph View Window Value	○	–	EXPR (Real Number)	25
xmax	View Window Display Range x -axis Maximum Value	○	–	EXPR (Real Number)	7.7
xmax3D	3D Graph View Window Display Range x -axis Maximum Value	○	–	EXPR (Real Number)	3
xmin	View Window Display Range x -axis Minimum Value	○	–	EXPR (Real Number)	–7.7
xmin3D	3D Graph View Window Display Range x -axis Minimum Value	○	–	EXPR (Real Number)	–3
xscl	View Window Display Range XScale	○	–	EXPR (Real Number)	1
$xt1(t)\sim xt100(t)$	Graph Expression Input Variable, Param Type	○ (Define)	○	FUNC	
\bar{y}	Mean of y (Statistics Calculation)	–	–	EXPR (Real Number)	
$y1(x)\sim y100(x)$	Graph Expression Input Variable, Y= Expression Type	○ (Define)	○	FUNC	
yc	Graph Coordinate Value Storage Variable	–	–	EXPR (Real Number)	0
ydot	View Window 1-dot y -axis Value	○	–	EXPR (Real Number)	0.1
yfact	Factor Zoom Y-factor Value	○	–	EXPR (Real Number)	2
ygrid3D	3D Graph View Window Value	○	–	EXPR (Real Number)	25



α -7-7
System Variable Table

Name	Description	Input	Delete	Data Type	Default
y _{max}	View Window Display Range y-axis Maximum Value	○	–	EXPR (Real Number)	3.8
y _{max3D}	3D Graph View Window Display Range y-axis Maximum Value	○	–	EXPR (Real Number)	3
y _{min}	View Window Display Range y-axis Minimum Value	○	–	EXPR (Real Number)	–3.8
y _{min3D}	3D Graph View Window Display Range y-axis Minimum Value	○	–	EXPR (Real Number)	–3
y _{scl}	View Window Display Range YScale	○	–	EXPR (Real Number)	1
y _{t1(t)~} y _{t100(t)}	Graph Expression Input Variable, Param Type	○ (Define)	○	FUNC	
z _{1(x,y)~} z _{100(x,y)}	3D Graph Function Expression	○ (Define)	○	FUNC	
z _c	Graph Coordinate Value Storage Variable	–	–	EXPR (Real Number)	0
z _{Lower}	Result of NormCD Calculation	–	–	EXPR (Real Number)	
z _{max3D}	3D Graph View Window Display Range z-axis Maximum Value	○	–	EXPR (Real Number)	3
z _{min3D}	3D Graph View Window Display Range z-axis Minimum Value	○	–	EXPR (Real Number)	–3
z _{Upper}	Result of NormCD Calculation	–	–	EXPR (Real Number)	
Z _{value}	z Value	–	–	EXPR (Real Number)	
θ _c	Graph Coordinate Value Storage Variable	–	–	EXPR (Real Number)	0
Σ _x	Sum of x (Statistics Calculation)	–	–	EXPR (Real Number)	
σ _x	Population Standard Deviation of x (Statistics Calculation)	–	–	EXPR (Real Number)	
Σ _{x²}	Sum of x ² (Statistics Calculation)	–	–	EXPR (Real Number)	
Σ _{xy}	Sum of xy Data (Statistics Calculation)	–	–	EXPR (Real Number)	
Σ _y	Sum of y (Statistics Calculation)	–	–	EXPR (Real Number)	
σ _y	Population Standard Deviation of y (Statistics Calculation)	–	–	EXPR (Real Number)	
Σ _{y²}	Sum of y ²	–	–	EXPR (Real Number)	
χ ² _{value}	χ ² Value	–	–	EXPR (Real Number)	



8 Command and Function Index

Command/Function	Form	Page
abExpR	Cmd	12-6-32
abExpReg	Cmd	12-6-27
abs	Func	2-4-5
absExpand	Func	2-8-45
\square and	Cmd	2-8-46
andConnect	Func	2-8-45
angle	Func	2-8-40
approx	Func	2-8-3
arcLen	Func	2-8-16
arg	Func	2-8-19
arrange	Func	2-8-47
augment	Func	2-8-22, 2-8-31, 2-8-39
baseConvert	Func	2-7-5
BinomialCD	Cmd	7-11-16
binomialCDF	Func	2-8-53
BinomialPD	Cmd	7-11-15
binomialPDF	Func	2-8-52
Box	Cmd	12-6-33
Break	Cmd	12-6-9
Broken	Cmd	12-6-32
CallUndef	Cmd	12-6-23
cExpand	Func	2-8-20
ChiCD	Cmd	7-11-10
chiCDF	Func	2-8-51
ChiGOFTest	Cmd	7-9-15
ChiPD	Cmd	7-11-9
chiPDF	Func	2-8-51
ChiTest	Cmd	7-9-14
ChrToNum	Cmd	12-6-41
Circle	Cmd	12-6-15
Clear_a_z	Cmd	2-8-48, 12-6-38
ClearSheet	Cmd	12-6-15
ClearSheet3D	Cmd	12-6-24
CloseComPort38k	Cmd	12-6-45
ClrGraph	Cmd	12-6-16
ClrText	Cmd	12-6-6
Cls	Cmd	12-6-16

Command/Function	Form	Page
colDim	Func	2-8-37
collect	Func	2-8-5
colNorm	Func	2-8-38
combine	Func	2-8-5
compToPol	Func	2-8-21
compToTrig	Func	2-8-21
conjg	Func	2-8-20
const	Func	2-4-15
constn	Func	2-4-15
CopyVar	Cmd	12-6-38
cos	Func	2-4-2
cos ⁻¹	Func	2-4-2
cosh	Func	2-4-4
cosh ⁻¹	Func	2-4-4
Cross	Cmd	12-6-32
crossP	Func	2-8-40
CubicR	Cmd	12-6-32
CubicReg	Cmd	12-6-28
cuml	Func	2-8-29
DefaultListEditor	Cmd	12-6-28
DefaultSetup	Cmd	12-6-33
Define	Cmd	2-8-57, 12-6-9
DelFolder	Cmd	12-6-39
DelVar	Cmd	2-8-57, 12-6-39
delta	Func	2-4-16
denominator	Func	2-8-19
det	Func	2-8-33
diag	Func	2-8-32
diff	Func	2-8-13
dim	Func	2-8-28, 2-8-33, 2-8-39
DispDfrTbl	Cmd	12-6-25
DispDQTbl	Cmd	12-6-25
DispFibTbl	Cmd	12-6-25
DispFTable	Cmd	12-6-16
DispListEditor	Cmd	12-6-28
DispQutTbl	Cmd	12-6-25



Command/Function	Form	Page
DispSeqTbl	Cmd	12-6-25
DispSmryTbl	Cmd	12-6-16
DispStat	Cmd	2-8-57, 12-6-28
DispText	Cmd	12-6-6
Distance	Cmd	12-6-16
dms	Func	2-8-7
Do~LpWhile	Cmd	12-6-9
Dot	Cmd	12-6-32
dotP	Func	2-8-40
DrawConics	Cmd	12-6-25
DrawFTGCon, DrawFTGPlot	Cmd	12-6-16
DrawGraph	Cmd	12-6-17
DrawSeqCon, DrawSeqPlt	Cmd	12-6-26
DrawSeqEtrCon, DrawSeqEtrPlt	Cmd	12-6-26
DrawShade	Cmd	12-6-17
DrawStat	Cmd	12-6-28
Draw3D	Cmd	12-6-24
dSolve	Func	2-8-8, 2-8-44
E	Cmd	
e^{\wedge}	Func	2-4-3
eigVc	Func	2-8-35
eigVl	Func	2-8-34
eliminate	Func	2-8-45
exchange	Func	2-8-45
expand	Func	2-8-4
ExpR	Cmd	12-6-32
ExpReg	Cmd	12-6-28
ExpToStr	Cmd	12-6-42
expToTrig	Func	2-8-6
factor	Func	2-8-4
factorOut	Func	2-8-5
FCD	Cmd	7-11-13
fCDf	Func	2-8-52
FFT	Func	2-8-11
fill	Func	2-8-22, 2-8-32, 2-8-39
fMax	Func	2-8-18
fMin	Func	2-8-17
For~To~(Step~)Next	Cmd	12-6-10
fourier	Func	2-8-9

Command/Function	Form	Page
FPD	Cmd	7-11-12
fPDF	Func	2-8-52
frac	Func	2-4-5
fRound	Func	2-4-5
gamma	Func	2-4-18
gcd	Func	2-8-18
GeoCD	Cmd	7-11-22
geoCDf	Func	2-8-55
GeoPD	Cmd	7-11-21
geoPDF	Func	2-8-55
GetFolder	Cmd	12-6-39
GetKey	Cmd	12-6-3
getLeft	Func	2-8-46
GetPen	Cmd	12-6-4
getRight	Func	2-8-45
GetType	Cmd	12-6-39
GetVar38k	Cmd	12-6-45
Goto~Lbl	Cmd	12-6-10
GraphType	Cmd	12-6-17
GTSelOff	Cmd	12-6-17
GTSelOn	Cmd	12-6-18
heaviside	Func	2-4-17
Histogram	Cmd	12-6-32
Horizontal	Cmd	12-6-18
HypergeoCD	Cmd	7-11-25
hypergeoCDf	Func	2-8-56
HypergeoPD	Cmd	7-11-24
hypergeoPDF	Func	2-8-56
i	Cmd	
ident	Func	2-8-31
IFFT	Func	2-8-11
If~Then~Else~Else ~IfEnd	Cmd	12-6-11
iGcd	Func	2-4-9
iLcm	Func	2-4-10
im	Func	2-8-20
iMod	Func	2-4-10
impDiff	Func	2-8-13
Input	Cmd	12-6-4
InputFunc	Cmd	12-6-5
InputStr	Cmd	12-6-5
int	Func	2-4-5
intg	Func	2-4-5
InvBinomialCD	Cmd	7-11-17



Command/Function	Form	Page
invBinomialCDf	Func	2-8-53
InvChiCD	Cmd	7-11-11
invChiCDf	Func	2-8-51
Inverse	Cmd	12-6-18
invert	Func	2-8-47
InvFCD	Cmd	7-11-14
invFCDf	Func	2-8-52
InvFourier	Func	2-8-9
InvGeoCD	Cmd	7-11-23
invGeoCDf	Func	2-8-55
InvHypergeoCD	Cmd	7-11-26
invHypergeoCDf	Func	2-8-56
invLaplace	Func	2-8-8
InvNorm	Cmd	7-11-6
InvNormCD	Cmd	7-11-6
invNormCDf	Func	2-8-50
InvPoissonCD	Cmd	7-11-20
invPoissonCDf	Func	2-8-54
InvTCD	Cmd	7-11-8
invTCDf	Func	2-8-51
isPrime	Func	2-4-13
judge	Func	2-4-12
laplace	Func	2-8-8
lcm	Func	2-8-19
Ldot	Cmd	12-6-32
lim	Func	2-8-15
Line	Cmd	12-6-18
LinearR	Cmd	12-6-32
LinearReg	Cmd	12-6-29
LinRegTTest	Cmd	7-9-13
listToMat	Func	2-8-24, 2-8-32
In	Func	2-4-3
Local	Cmd	12-6-40
Locate	Cmd	12-6-7
Lock	Cmd	12-6-40
LockFolder	Cmd	12-6-40
log	Func	2-4-3
LogisticR	Cmd	12-6-32
LogisticReg	Cmd	12-6-29
LogP	Cmd	12-6-23
LogR	Cmd	12-6-32
LogReg	Cmd	12-6-29

Command/Function	Form	Page
LU	Func	2-8-35
matToList	Func	2-8-24, 2-8-33
max	Func	2-8-25
mean	Func	2-8-26
MedBox	Cmd	12-6-32
median	Func	2-8-26
MedMed	Cmd	12-6-32
MedMedLine	Cmd	12-6-29
Message	Cmd	12-6-7
min	Func	2-8-25
mod	Func	2-8-16
ModBox	Cmd	12-6-32
mode	Func	2-8-26
MoveVar	Cmd	12-6-40
mRow	Func	2-8-36
mRowAdd	Func	2-8-37
MultiSortA	Cmd	12-6-30
MultiSortD	Cmd	12-6-30
nCr	Func	2-4-11
NDist	Cmd	12-6-32
NewFolder	Cmd	12-6-40
norm	Func	2-8-34, 2-8-40
normal	Func	2-8-16
NormalLine	Cmd	12-6-18
NormCD	Cmd	7-11-5
normCDf	Func	2-8-50
NormPD	Cmd	7-11-4
normPDF	Func	2-8-49
not	Func	2-8-46
NPPlot	Cmd	12-6-32
nPr	Func	2-4-11
Number	Cmd	12-6-33
numerator	Func	2-8-19
NumToChr	Cmd	12-6-42
NumToStr	Cmd	12-6-42
Off	Cmd	
On	Cmd	
OnePropZInt	Cmd	7-10-6
OnePropZTest	Cmd	7-9-6
OneSampleTInt	Cmd	7-10-8
OneSampleTTest	Cmd	7-9-9



Command/Function	Form	Page
OneSampleZInt	Cmd	7-10-3
OneSampleZTest	Cmd	7-9-3
OneVariable	Cmd	12-6-30
OneWayANOVA	Cmd	7-9-18
OpenComPort38k	Cmd	12-6-46
<input type="checkbox"/> or	Cmd	2-8-46
Pause	Cmd	12-6-13
percent	Func	2-8-29
percentile	Func	2-8-27
piecewise	Func	2-4-12
Plot	Cmd	12-6-18
PlotChg	Cmd	12-6-18
PlotOff	Cmd	12-6-19
PlotOn	Cmd	12-6-19
plotTest(Func	12-6-19
PoissonCD	Cmd	7-11-19
poissonCDF	Func	2-8-54
PoissonPD	Cmd	7-11-18
poissonPDF	Func	2-8-54
polyEval	Func	2-8-29
PowerR	Cmd	12-6-32
PowerReg	Cmd	12-6-30
Print	Cmd	12-6-7
PrintNatural	Cmd	12-6-8
prod	Func	2-8-28
propFrac	Func	2-8-7
PTBrokenThck	Cmd	12-6-19
PTCross	Cmd	12-6-19
PTDot	Cmd	12-6-19
PTNormal	Cmd	12-6-19
PTSquare	Cmd	12-6-19
PTThick	Cmd	12-6-20
PxlChg	Cmd	12-6-20
PxlOff	Cmd	12-6-20
PxlOn	Cmd	12-6-20
pxlTest(Func	12-6-20
Q ₁	Func	2-8-27
Q ₃	Func	2-8-27
QR	Func	2-8-36
QuadR	Cmd	12-6-32
QuadReg	Cmd	12-6-31
QuartR	Cmd	12-6-32
QuartReg	Cmd	12-6-31

Command/Function	Form	Page
rand	Func	2-4-7
randBin	Func	2-4-8
randList	Func	2-4-7
randNorm	Func	2-4-7
RandSeed	Cmd	2-4-9
rangeAppoint	Func	2-8-16
rank	Func	2-8-34
RclGMem	Cmd	12-6-20
RclPict	Cmd	12-6-20
RclVWin	Cmd	12-6-21
re	Func	2-8-20
Receive38k	Cmd	12-6-46
ref	Func	2-8-34
Rename	Cmd	12-6-40
replace	Func	2-8-47
Return	Cmd	12-6-13
rewrite	Func	2-8-44
rFactor	Func	2-8-5
rotate	Func	2-8-23
rowAdd	Func	2-8-37
rowDim	Func	2-8-37
rowNorm	Func	2-8-37
rref	Func	2-8-34
rSolve	Func	6-3-5
Scatter	Cmd	12-6-32
SelOn3D	Cmd	12-6-24
Send38k	Cmd	12-6-46
SendVar38k	Cmd	12-6-46
seq	Func	2-8-22
SeqSelOff	Cmd	12-6-26
SeqSelOn	Cmd	12-6-27
SeqType	Cmd	12-6-27
sequence	Func	2-8-30
SetAxes	Cmd	12-6-33
SetAxes3D	Cmd	12-6-33
SetBG	Cmd	12-6-33
SetCellWidth	Cmd	12-6-33
SetComplex	Cmd	12-6-33
SetCoord	Cmd	12-6-34
SetCoordOff3D	Cmd	12-6-34
SetCoordPol3D	Cmd	12-6-34
SetCoordRect3D	Cmd	12-6-34
SetDecimal	Cmd	12-6-34



Command/Function	Form	Page
SetDegree	Cmd	12-6-34
SetDeriv	Cmd	12-6-34
SetDispGCon	Cmd	12-6-35
SetDrawCon	Cmd	12-6-35
SetDrawPit	Cmd	12-6-35
SetFix	Cmd	12-6-35
SetFolder	Cmd	12-6-41
SetFunc	Cmd	12-6-35
SetGrad	Cmd	12-6-35
SetGrid	Cmd	12-6-35
SetLabel	Cmd	12-6-35
SetLabel3D	Cmd	12-6-36
SetLeadCursor	Cmd	12-6-36
SetNormal	Cmd	12-6-36
SetRadian	Cmd	12-6-36
SetReal	Cmd	12-6-36
SetSci	Cmd	12-6-36
SetSequence	Cmd	12-6-37
SetSimulGraph	Cmd	12-6-37
SetSmryTable	Cmd	12-6-37
SetSmryTableQD	Cmd	12-6-37
SetStandard	Cmd	12-6-37
SetStatWinAuto	Cmd	12-6-37
SetTVariable	Cmd	12-6-38
SetΣdisp	Cmd	12-6-38
SheetActive	Cmd	12-6-21
SheetActive3D	Cmd	12-6-24
SheetName	Cmd	12-6-21
SheetName3D	Cmd	12-6-24
shift	Func	2-8-23
signum	Func	2-4-5
simplify	Func	2-8-4
sin	Func	2-4-2
sin ⁻¹	Func	2-4-2
sinh	Func	2-4-4
sinh ⁻¹	Func	2-4-4
SinR	Cmd	12-6-32
SinReg	Cmd	12-6-31
Skip	Cmd	12-6-13
SmryTSELon	Cmd	12-6-21
solve	Func	2-8-8, 2-8-43
sortA	Func	2-8-23

Command/Function	Form	Page
sortD	Func	2-8-24
Square	Cmd	12-6-32
sRound	Func	2-4-5
StatGraph	Cmd	12-6-32
StatGraphSel	Cmd	12-6-32
stdDev	Func	2-8-27
StepDisp	Cmd	12-6-37
StoGMem	Cmd	12-6-21
Stop	Cmd	12-6-13
StoPict	Cmd	12-6-22
StoVWin	Cmd	12-6-22
StrCmp	Cmd	12-6-42
StrInv	Cmd	12-6-42
StrJoin	Cmd	12-6-43
StrLeft	Cmd	12-6-43
StrLen	Cmd	12-6-43
StrLwr	Cmd	12-6-43
StrMid	Cmd	12-6-43
StrRight	Cmd	12-6-43
StrRotate	Cmd	12-6-44
StrShift	Cmd	12-6-44
StrSrc	Cmd	12-6-44
strToExp(Func	12-6-44
StrUpr	Cmd	12-6-44
subList	Func	2-8-23
subMat	Func	2-8-32
sum	Func	2-8-28
sumSeq	Func	2-8-30
swap	Func	2-8-36
Switch~Case~Default~SwitchEnd	Cmd	12-6-14
TableInput	Cmd	12-6-38
tan	Func	2-4-2
tan ⁻¹	Func	2-4-2
TangentLine	Cmd	12-6-22
tanh	Func	2-4-4
tanh ⁻¹	Func	2-4-4
tanLine	Func	2-8-16
taylor	Func	2-8-8
TCD	Cmd	7-11-8
tCDF	Func	2-8-51
tCollect	Func	2-8-6
tExpand	Func	2-8-6
Text	Cmd	12-6-22



Command/Function	Form	Page
toCyl	Func	2-8-42
toDMS	Func	2-8-7
toFrac	Func	2-8-6
toPol	Func	2-8-41
toRect	Func	2-8-41
toSph	Func	2-8-41
TPD	Cmd	7-11-7
tPDF	Func	2-8-50
trigToExp	Func	2-8-6
trn	Func	2-8-31
TwoPropZInt	Cmd	7-10-7
TwoPropZTest	Cmd	7-9-7
TwoSampleFTest	Cmd	7-9-17
TwoSampleTInt	Cmd	7-10-10
TwoSampleTTest	Cmd	7-9-11
TwoSampleZInt	Cmd	7-10-4
TwoSampleZTest	Cmd	7-9-5
TwoVariable	Cmd	12-6-32
TwoWayANOVA	Cmd	7-9-19
unitV	Func	2-8-39
Unlock	Cmd	12-6-41
UnlockFolder	Cmd	12-6-41
variance	Func	2-8-28
Vertical	Cmd	12-6-22
ViewWindow	Cmd	12-6-23
ViewWindow3D	Cmd	12-6-24
VWin	Cmd	12-6-37
Wait	Cmd	12-6-14
While~WhileEnd	Cmd	12-6-15
\square xor	Cmd	2-8-46
xyLine	Cmd	12-6-32
ZAuto	Cmd	12-6-23
ZFactor	Cmd	12-6-23
+	Cmd	
-	Cmd	
×	Cmd	
/	Cmd	
^	Cmd	2-4-3
^2	Cmd	2-4-5
^(-1)	Cmd	2-4-5
=	Cmd	2-4-14
≠	Cmd	2-4-14
<	Cmd	2-4-14

Command/Function	Form	Page
>	Cmd	2-4-14
≤	Cmd	2-4-14
≥	Cmd	2-4-14
!	Cmd	2-4-5
%	Cmd	2-4-5
(with)	Cmd	2-4-14
ʀ	Cmd	2-4-1
°	Cmd	2-4-1
⇒	Cmd	12-6-8
#	Cmd	12-6-8
'	Cmd	2-4-13, 12-6-2
"	Cmd	12-6-41
π	Cmd	
∞	Cmd	2-4-15
∠	Func	2-4-13
√	Func	2-4-5
Σ	Func	2-8-15
Π	Func	2-8-15
∫	Func	2-8-14
Δlist	Func	2-8-29
: (Multi-statement Command)		12-6-2
(Carriage Return)		12-6-2



9 Graph Types and Executable Functions

○: Executable -: Not executable △: Executable with some conditions

Function		Graph Type		y=		r=		xt=	
				○	○	○	○	○	○
				During Log Graphing	During Log Graphing	During Log Graphing	During Log Graphing	During Log Graphing	
Zoom	Box	○	○	○	○	○	○	○	
	In	○	○	○	○	○	○	○	
	Out	○	○	○	○	○	○	○	
	Auto	○	○	○	○	○	○	○	
	Original	○	○	○	○	○	○	○	
	Square	○	△ (Both logarithms only)	○	△ (Both logarithms only)	○	△ (Both logarithms only)	○	
	Round	○	-	○	-	○	-	-	
	Integer	○	-	○	-	○	-	-	
	Previous	○	○	○	○	○	○	○	
	Quick Types	○	-	○	-	○	-	-	
Analysis	Trace	○	○	○	○	○	○	○	
	Sketch	Cls	○	○	○	○	○	○	○
		Plot	○	○	○	○	○	○	○
		Line	○	-	○	-	○	-	-
		Text	○	○	○	○	○	○	○
		Tangent	○	○	○	○	○	○	○
		Normal	○	○	○	○	○	○	○
		Inverse	○	○	-	-	-	-	-
		Circle	○	-	○	-	○	-	-
		Vertical	○	○	○	○	○	○	○
		Horizontal	○	○	○	○	○	○	○
	G-Solve	Root	○	○	-	-	-	-	-
		Max	○	○	-	-	-	-	-
		Min	○	○	-	-	-	-	-
		fMax	○	○	-	-	-	-	-
		fMin	○	○	-	-	-	-	-
		y-Intercept	○	○	-	-	-	-	-
		Intersect	○	○	-	-	-	-	-
		y-cal	○	○	○	○	○	○	○
		x-cal	○	○	○	○	-	-	-
		∫ dx	○	-	-	-	-	-	-
		Inflection	○	○	-	-	-	-	-
		Distance	○	○	○	○	○	○	○
		$\pi \int f(x)^2 dx$	○	-	-	-	-	-	-
	Modify	Dynamic Modify	○	○	○	○	○	○	○
Direct Modify		○	○	-	-	-	-	-	



Graph Types and Executable Functions

Function		Graph Type		x=		y Inequality		x Inequality		
				○		○		○		
					During Log Graphing		During Log Graphing		During Log Graphing	
Zoom	Box	○	○	○	○	○	○	○	○	
	In	○	○	○	○	○	○	○	○	
	Out	○	○	○	○	○	○	○	○	
	Auto	○	○	○	○	○	○	○	○	
	Original	○	○	○	○	○	○	○	○	
	Square	○	△ (Both logarithms only)	○	△ (Both logarithms only)	○	△ (Both logarithms only)	○	△ (Both logarithms only)	
	Round	○	—	○	—	○	—	○	—	
	Integer	○	—	○	—	○	—	○	—	
	Previous	○	○	○	○	○	○	○	○	
	Quick Types	○	—	○	—	○	—	○	—	
	Analysis	Trace	○	○	○	○	○	○	○	○
Sketch		Cls	○	○	○	○	○	○	○	○
		Plot	○	○	○	○	○	○	○	○
		Line	○	—	○	—	○	—	○	—
		Text	○	○	○	○	○	○	○	○
		Tangent	○	○	○	○	○	○	○	○
		Normal	○	○	○	○	○	○	○	○
		Inverse	○	○	—	—	—	—	—	—
		Circle	○	—	○	—	○	—	○	—
		Vertical	○	○	○	○	○	○	○	○
		Horizontal	○	○	○	○	○	○	○	○
G-Solve		Root	—	—	○	○	—	—	—	—
		Max	—	—	○	○	—	—	—	—
		Min	—	—	○	○	—	—	—	—
		fMax	—	—	○	○	—	—	—	—
		fMin	—	—	○	○	—	—	—	—
		y-Intercept	—	—	○	○	—	—	—	—
		Intersect	—	—	○	○	—	—	—	—
		y-cal	—	—	○	○	—	—	—	—
		x-cal	—	—	○	○	—	—	—	—
		∫ dx	—	—	—	—	—	—	—	—
		Inflection	—	—	○	○	—	—	—	—
		Distance	○	○	○	○	○	○	○	○
$\pi \int f(x)^2 dx$	—	—	—	—	—	—	—	—		
Modify	Dynamic Modify	○	○	○	○	○	○	○	○	
	Direct Modify	—	—	—	—	—	—	—	—	



Graph Types and Executable Functions

Function		Graph Type		y ◆		3D		Statistical - Plot	
				○	○	—	—	○	○
			During Log Graphing		During Log Graphing		During Log Graphing		
Zoom	Box	○	○	—	—	○	○		
	In	○	○	○	—	○	○		
	Out	○	○	○	—	○	○		
	Auto	○	○	—	—	—	—		
	Original	○	○	—	—	○	○		
	Square	○	△ (Both logarithms only)	—	—	○	△ (Both logarithms only)		
	Round	○	—	—	—	○	—		
	Integer	○	—	—	—	○	—		
	Previous	○	○	—	—	○	○		
	Quick Types	○	—	—	—	○	—		
Analysis	Trace	○	○	○	—	○	○		
	Sketch	CIs	○	○	○	—	○	○	
		Plot	○	○	—	—	○	○	
		Line	○	—	—	—	○	—	
		Text	○	○	○	—	○	○	
		Tangent	○	○	—	—	—	—	
		Normal	○	○	—	—	—	—	
		Inverse	—	—	—	—	—	—	
		Circle	○	—	—	—	○	—	
		Vertical	○	○	—	—	○	○	
		Horizontal	○	○	—	—	○	○	
	G-Solve	Root	—	—	—	—	—	—	
		Max	—	—	—	—	—	—	
		Min	—	—	—	—	—	—	
		fMax	—	—	—	—	—	—	
		fMin	—	—	—	—	—	—	
		y-Intercept	—	—	—	—	—	—	
		Intersect	—	—	—	—	—	—	
		y-cal	—	—	△(z-cal)	—	—	—	
		x-cal	—	—	—	—	—	—	
		∫ dx	—	—	—	—	—	—	
		Inflection	—	—	—	—	—	—	
		Distance	○	○	—	—	—	—	
$\pi \int f(x)^2 dx$	—	—	—	—	—	—			
Modify	Dynamic Modify	○	○	—	—	—	—		
	Direct Modify	—	—	—	—	—	—		

- Statistical - Plot
- Scatter
 - Histogram
 - xyLine
 - Broken
 - NPPlot



Graph Types and Executable Functions

Function		Graph Type	Statistical Regression		Statistical - Box		Conics		
			○		○		○		
				During Log Graphing		During Log Graphing		During Log Graphing	
Zoom	Box		○	○	○	○	○	○	
	In		○	○	○	○	○	○	
	Out		○	○	○	○	○	○	
	Auto		—	—	—	—	○	○	
	Original		○	○	○	○	○	○	
	Square		○	△ (Both logarithms only)	○	△ (Both logarithms only)	○	△ (Both logarithms only)	
	Round		○	—	○	—	○	—	
	Integer		○	—	○	—	○	—	
	Previous		○	○	○	○	○	○	
	Quick Types		○	—	○	—	○	—	
Analysis	Trace		○	○	○	○	○	○	
	Sketch	Cls		○	○	○	○	○	○
		Plot		○	○	○	○	○	○
		Line		○	—	○	—	○	—
		Text		○	○	○	○	○	○
		Tangent		○	○	—	—	—	—
		Normal		○	○	—	—	—	—
		Inverse		○	○	—	—	—	—
		Circle		○	—	○	—	○	—
		Vertical		○	○	○	○	○	○
		Horizontal		○	○	○	○	○	○
	G-Solve	Root		—	—	—	—	—	—
		Max		—	—	—	—	—	—
		Min		—	—	—	—	—	—
		fMax		—	—	—	—	—	—
		fMin		—	—	—	—	—	—
		y-Intercept		—	—	—	—	○	○
		Intersect		—	—	—	—	—	—
		y-cal		—	—	—	—	○	○
		x-cal		—	—	—	—	○	○
		∫ dx		—	—	—	—	—	—
		Inflection		—	—	—	—	—	—
		Distance		—	—	—	—	—	—
$\pi \int f(x)^2 dx$		—	—	—	—	—	—		
Modify	Dynamic Modify		○	○	—	—	—	—	
	Direct Modify		○	○	—	—	—	—	

Statistical Regression

- NDist • QuadR • LogR • PowerR
- LinearR • CubicR • ExpR • SinR
- MedMed • QuartR • abExpR • LogisticR

Statistical - Box

- MedBox
- ModBox



10 Error Message Table

■ Error Message Table

Error Message	Description
A single presentation can contain up to 60 pages.	–
Access to Flash ROM	–
Argument must be a variable name	–
Can't Create	–
Can't Delete	–
Can't Edit	–
Can't Rename	–
Can't Transform into This Type	–
Circular Reference	Circular reference exists for a variable.
Communication Failure	–
Compressed Program. Impossible to Edit.	–
Current Folder	You attempted to perform an operation that is prohibited for the current folder.
Data size	–
Delete or store operation is invalid for program/function type	–
Dependent Value	–
Division by 0	–
Domain	An argument value is outside of the specified Domain range.
Duplicate Name	–
Exceeds Maximum Length of Line	A line in your program exceeds the allowable length.
Exceeds Maximum Number of Folders	–
Exceeds Maximum Number of Variables	The operation you are attempting creates variables that cause the maximum number of allowable variables to be exceeded.
Exception Error Occurred	–
Failed in Undefined Window Calculation	–
Failed to capture. Select a presentation file to save pages.	–
Flash ROM! Initialize Flash ROM immediately at System application!	–



α-10-2
Error Message Table

Error Message	Description
Folder	The folder name you specified for a command argument does not exist. Or you have input the name of a folder that cannot be specified (“library” folder, etc.)
Function has invalid variable name	–
Function Type	The expression type that is selected cannot execute a function.
History Full	The operation you are performing creates a history entry that causes history contents to exceed the allowable limit.
Incorrect Argument	–
Incorrect Jump	A “Goto” command is used without a corresponding “Lbl” command.
Incorrect Number of Arguments	–
Incorrect Number of Parenthesis	–
Incorrect Program Call	–
Insufficient Elements	–
Insufficient Memory	There is not enough memory to complete the operation you are trying to perform.
Invalid Bounds	The specified boundary conditions are not appropriate for the operation being performed.
Invalid Code	–
Invalid Data Type	The calculation you are trying to perform has an invalid data type as an argument.
Invalid Dimension	The two lists or matrices you are trying to perform a calculation between have different dimensions.
Invalid for Local Variable	You attempted to perform an operation that is prohibited for a local variable.
Invalid in a Function or Current Expression	You are trying to perform a calculation using a expression that contains an illegal command (or function).
Invalid Name	You are trying to use an improper folder name, variable name (including functions and programs), or label name.



α -10-3
Error Message Table

Error Message	Description
Invalid Outside Function or Program	You are trying to execute a command that must be used inside of a program as a local command, outside of a program.
Invalid Path	You are trying to specify an invalid path. This error occurs when you include a system folder in a path, when you include a system variable in a path, or when you try to specify a path where path specification is not allowed.
Invalid String	The command you are trying to execute has an invalid string specified as an argument.
Invalid Syntax	The syntax you are trying to use is not correct.
Invalid Table Input Value	–
Invalid Variable Reference	The variable you are trying to access does not exist. This error occurs when you try to read the contents of a system variable that does not contain any data, etc.
Invalid View Window Value	–
Locked or Protected	–
Maximum value needs to be larger than minimum	–
Memory is full	Memory has become full during a data communication operation.
Missing ”	–
Name is up to 8 bytes	–
Negative Value Set in Scale	–
Nesting of subroutines exceeds 40 levels	–
No file is specified	–
No Formula Selected	–
No Item(s) Checked	–
No Sequences Selected	–
No Sheet Name	–
No Solution	–
No Stat Graphs Selected	–
No Variable	–
No word is specified	–
Non-Algebraic Variable in Expression	You are attempting to use a variable that cannot be used in a calculation.



α-10-4
Error Message Table

Error Message	Description
Non-Real in Calc	The ClassPad is in the Real mode but the value you are inputting or the result produced by a calculation is a complex number.
Not a Local Variable	The variable you are trying to assign data to is not a local variable.
Not a Numerical Value Result	–
Not an Empty Folder	You are trying to delete or perform some other operation on a folder that is not empty.
Not Appropriate Numerical Value Input	–
Not Found	–
Not Function Name or Program Name	–
Over 30 factors have occurred	The number of factors in a summary table has exceeded 30.
Overflow	–
Page Size	–
Presentation file is not selected or does not exist.	–
Receiving Failure	–
Reserved Name or System Variable	–
Stack	–
Stat Calculation	–
Stat Graph Setting	–
This name already exists	–
Too Long Sheet Name	–
Too Long String	–
Transmission Failure	–
Undefined Result in Condition Judgment	A condition judgment program control command has performed comparison with an undefined variable, which returns a condition judgment of “Undefined”.
Undefined Variable	–
Variable in Use	–
View Window settings for log contain a 0 or negative value.	–
View Window value is out of range	–
Wrong Argument Type	–



■ Warning Message Table

Warning Message	Description
Batteries are extremely low! Replace batteries immediately!	–
Can't Solve!	–
Can't solve! Adjust initial value or bounds. Then try again.	NumSolve cannot solve an expression.
Insufficient memory for unit-to-unit communication. Delete unnecessary eActivity contents.	–
Only the first selected function will be done.	–
This operation will make your presentation files unavailable. Are you sure?	–
Time out. The end of condition was not satisfied.	–
Too Many eActivity Files	The data communication operation you are trying to perform is not possible because there are too many eActivity files.

■ Low Memory Error Processing

An error occurs on the ClassPad if it is unable to reserve enough work area memory to perform a particular operation. When a low memory error occurs, any application in use at that point is shut down and an error message like the one shown below appears.



Tapping the [OK] button clears the error.

Important!

- To avoid loss of data, you should make it a regular habit to periodically perform the save operation.

You may lose some of the data you are inputting with an application that shuts down due to a low memory error. When the low memory error occurs while you are using the eActivity application to create data, for example, any unsaved data you have input is lost.



NL

**Batterij niet weggooien,
maar inleveren als
KCA**

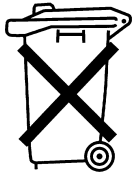

Manufacturer:
CASIO COMPUTER CO., LTD.
6-2, Hon-machi 1-chome
Shibuya-ku, Tokyo 151-8543, Japan

Responsible within the European Union:
CASIO EUROPE GmbH
Casio-Platz 1
22848 Norderstedt, Germany



This mark applies in EU countries only.



CASIO®

CASIO COMPUTER CO., LTD.

6-2, Hon-machi 1-chome
Shibuya-ku, Tokyo 151-8543, Japan

One or more of the following patents may be used in the product.
U.S.Pats. 5,539,867